

SPLIT TYPE ROOM AIR CONDITIONER OPERATION MANUAL



AS25S2SJ1FA-3
AS35S2SJ1FA-3
AS50S2SJ1FA-3

- Please read this operation manual before using the air conditioner.
Keep this operation manual for future reference.

0011515508



English

Español

Italiano

Français

Deutsch

Português

POLSKI

TÜRKÇE

ΕΛΛΗΝΙΚΑ

HRVATSKI

Български

Русский

Nederlands

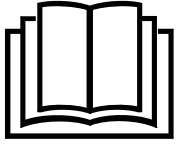

Read the precautions in this manual carefully before operating the unit.



This appliance is filled with R32.

Keep this manual where the user can easily find it.

WARNING:

- Do not use means to accelerate the defrosting process or to clean, other than those recommended by the manufacturer.
- The appliance must be stored in a room without continuously operating ignition sources (for example: open flames, an operating gas appliance or an operating electric heater).
- Do not pierce or burn.
- Be aware that refrigerants may not contain an odour.
- The appliance must be installed, operated and stored in a room with a floor area larger than 3 m².
- If the supply cord is damaged, it must be replaced by the manufacturer, its service agent or similarly qualified persons in order to avoid a hazard.
- This appliance can be used by children aged 8 years and above and persons with reduced physical, sensory or mental capabilities or lack of experience and knowledge if they have been given supervision or instruction concerning use of the appliance in a safe way and understand the hazards involved. Children shall not play with the appliance. Cleaning and user maintenance shall not be made by children without supervision.
- The wiring method should be in line with the local wiring standard.
- All the cables shall have got the European authentication certificate. During installation, when the connecting cables break off, it must be assured that the grounding wire is the last one to be broken off. The explosion-proof breaker of the air conditioner should be all-pole switch. Distance between its two contacts should not be no less than 3mm. Such means for disconnection must be incorporated in the wiring.
- Make sure installation is done according to local wiring regulation by professional persons.
- Make sure ground connection is correct and reliable.
- A leakage explosion-proof breaker must be installed.
- Do not use a refrigerant other than the one indicated on the outdoor unit(R32) when installing, moving or repairing. Using other refrigerants may cause trouble or damage to the unit, and personal injury.

Contents

PARTS AND FUNCTIONS	1
OPERATION	3
INDOOR UNIT INSTALLATION	15
MAINTENANCE	18
CAUTIONS	19
TROUBLE SHOOTING	20

Visual air quality function

This product has built-in dust sensor and humidity sensor, which can detect the humidity and quality of the indoor ambient air intelligently. It gives alarm when the PM2.5 exceeding the standards with the lamp belt turning red which shall be green under normal conditions. It can realize accurate judgment, and enable you to learn about the air conditions in your house at all times.

PM2.5 removal function

This product has two methods to remove particle pollutants with one using HEPA high-efficiency dust removal filter to remove PM2.5 and PM10 etc. powerfully, and the other one using international leading IFD light ion high-efficiency dust collection technology to remove PM0.3 and PM2.5 etc. powerfully. They show not only significant effects, but also high safety relying on the automatic detection, reminder and removal functions. However, the two functions cannot be used simultaneously.

Wi-Fi function

This product can realize remote control, operation, management, energy consumption query, sleep curve setting and other functions through Wi-Fi to have the users enjoy comfortable temperature quietly. Equipment needing to be provided by the users: smart phone with Android or IOS operating system, and wireless router (needing to be connected to the Internet).

Quiet function

Haier air conditioner has quiet function to have the machine operate quietly.

Parts and Functions

Wi-Fi function description

The system architecture diagram

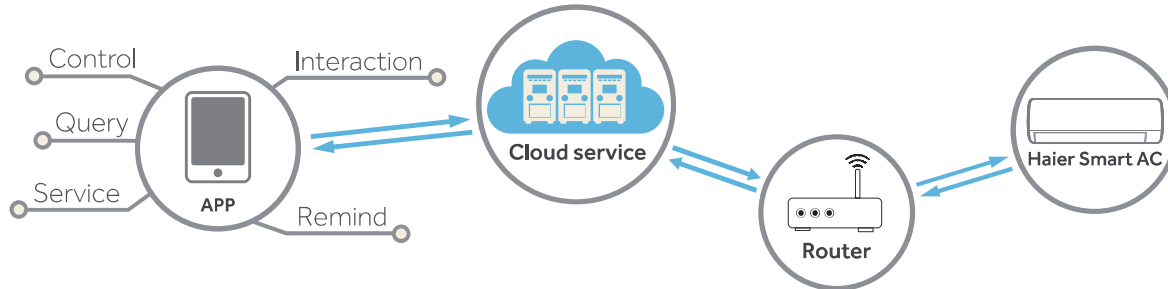

The application environment

Smart mobile phone and wireless router are necessary for the application.
Wireless router must be able to connect to the Internet.
Smart mobile phone requires IOS or Android system:



IOS system
must support IOS 9.0 or above



Android system
must support Android 5.0 or above

Configuration method

Scan the QR code below to download "hOn" APP.
Other Download options: Please search hOn APP on:

- App Store (IOS)
- Google Play (Android)
- Huawei AppGallery (Android)



After App Download, please register, connect the air conditioner and enjoy using hOn to manage your device. Please refer to the HELP section inside the APP for more details about how to register, connect the unit, and other operations.

Parts and Functions

Indoor Unit

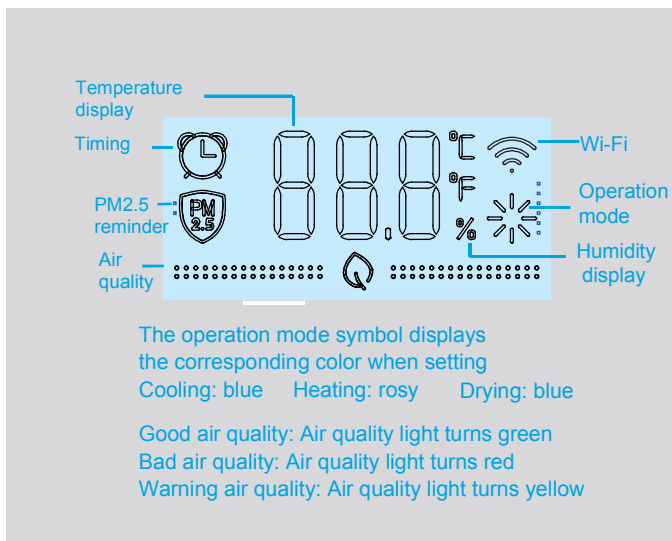
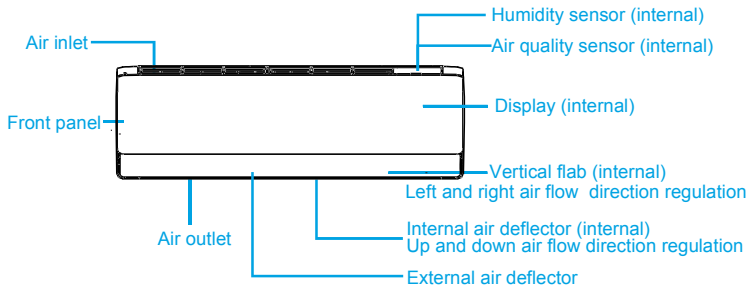

Actual inlet grille may vary from the one shown in the manual according to the product purchased

Outdoor Unit

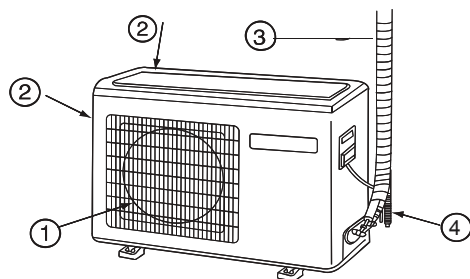

Remote controller

Outer side of the controller

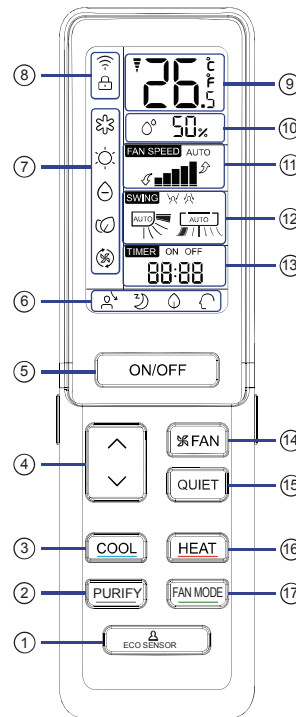

- ECO SENSOR button
- PURIFY button
Used to set PURIFY operation.
- COOL button
Used to set COOL operation.
- TEMP button
used to change setting temperature

- ON / OFF button
- Display of each function status
- Operation mode display
- Wi-Fi and CLOCK display
- TEMP display
- Humidity display
- FAN SPEED display
- SWING display
Swing up/down display
swing left/right display
- TIMER ON display
TIMER OFF display
CLOCK display
- FAN button
- QUIET button
- HEAT button
- FAN MODE button

NOTE:

- Humidity display is unavailable on some models
- If the model you buy has a Wi-Fi function, press the "ON/OFF" button for 5s to emit the Wi-Fi binding signal. Once in the binding mode, the APP will show how to bind.

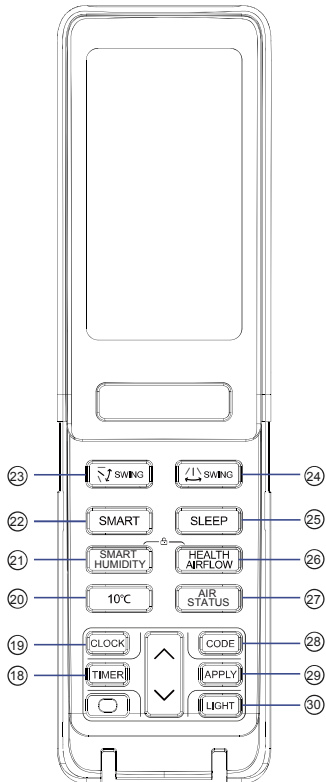

Operation

English

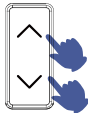

- 18. TIMER button
- 19. CLOCK button
- 20. 10 °C button
special heating set
function: 10 degree
heating maintaining
(valuable for RS)
- 21. SMART HUMIDITY button
- 22. SMART button
Used to set SMART
operation. (This function
is unavailable on some
models.)
- 23. SWING up/down button
- 24. SWING left/right button
- 25. SLEEP button
- 26. HEALTH AIRFLOW button
- 27. AIR STATUS button
- 28. CODE button
A-b yard
- 29. APPLY button
- 30. LIGHT button
Control the lightening and
extinguishing of the indoor
LED display board.

■ Clock and Lock set

- 1 Press CLOCK button,

- 2 Press "+" or "-" to set
correct time.

Each press will increase or
decrease 1min. If the button is
kept pressed, time will change
quickly.
- 3 Confirm time.

After time setting is confirmed,
press APPLY, "AM" and
"PM" stop flashing, while clock
starts working.

Press "SMART HUMIDITY" + "HEALTH AIRFLOW" simultaneously can set and cancel the "LOCK" function ()

Note:

The distance between the signal transmission head and the receiver hole should be within 7m without any obstacle as well. When electronic-started type fluorescent lamp or change-over wireless telephone is installed in the type fluorescent lamp or room, the receiver is apt to be disturbed in receiving the signals, so the distance to the indoor unit should be shorter.

Full display or unclear display during operation indicates the batteries have been used up. Please change batteries.

If the remote controller can't run normally during operation, please remove the batteries and reload several minutes later

Hint:

Remove the batteries in case unit won't be in usage for a long period.

Operation

QUIET Operation

COOL,HEAT Operation

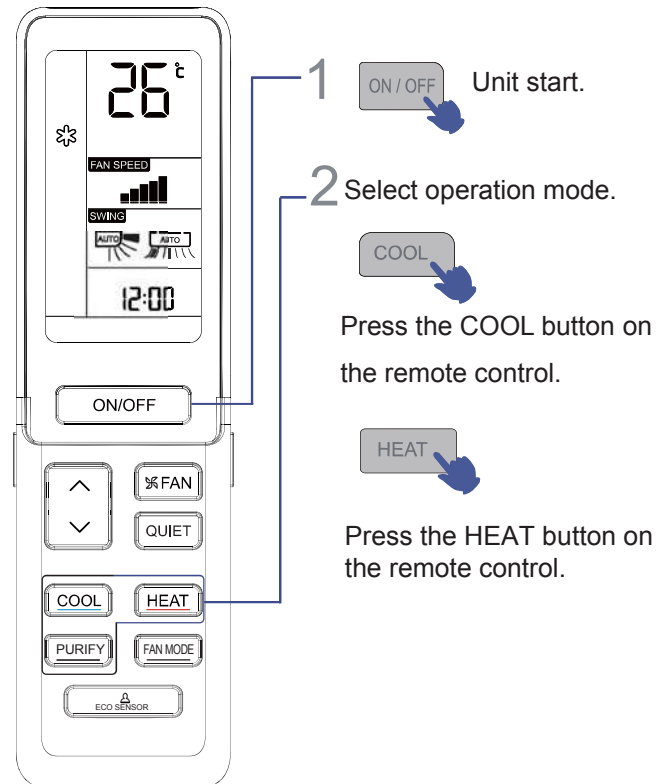
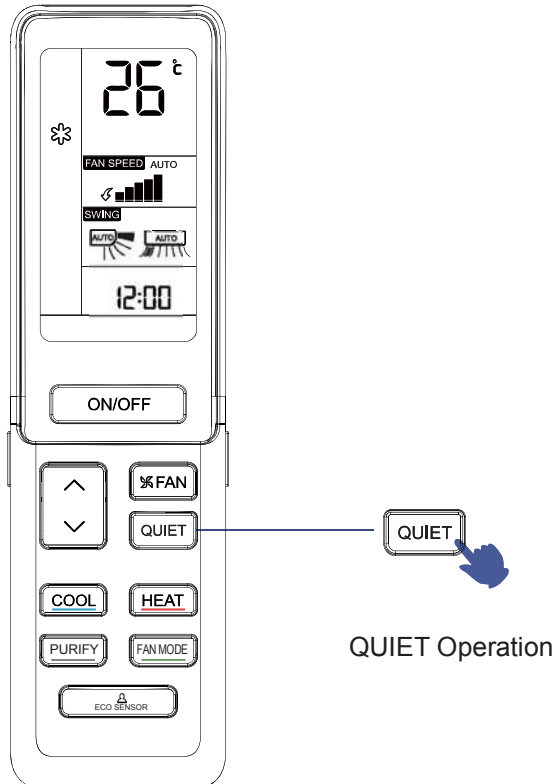

You can use this function when silence is needed for rest or reading.

For each press,  is displayed. Air conditioner starts QUIET function operation. In QUIET operation mode, fan speed automatically takes low speed of AUTO fan mode.

Press QUIET button again,  disappears, the operation stops.

Operation

PURIFY Operation

English

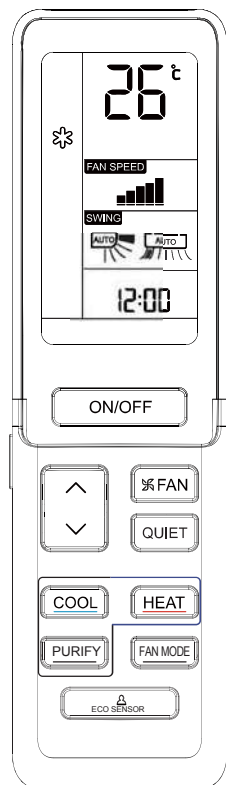

Press the PURIFY button on the remote control.

Purifying Function:

* Hepa filter:

While the machine is OFF or FAN, if you press the PURIFY button, the dust removal filter will slide to the working position within three minutes, and start purifying.

Exit method:

While the air conditioner is operating in the purifying mode, if you press down the PURIFY button, then the purifying function will be cancelled and the dust removal filter will slide back its original position.

Matters needing attention:

1. For Hepa filter, after the purifying function is turned on, the air conditioner will switch from the current mode (cooling/heating/drying) to the fan and purifying mode automatically.
2. For Hepa filter, in the purifying mode, the internal air deflector and the vertical flaps will turn to the purifying position. In the purifying mode, position of the deflector is not adjustable.
3. After the purifying function is turned on, the fan speed will change to high position automatically.
4. When the purifying function is turned on, due to the sliding of the dust removal filter, slight noise may be generated and this is a normal phenomenon.
5. If the air quality indicator light still shows red after the purifying has been operated for a long time period, we recommend you to replace and clean the dust removal filter.
6. You cannot enter the purifying mode from the self-cleaning mode directly.
7. The purifying module of this product has transmission mechanism, so please do not switch on and off the purifying function frequently.

Purifying Function:

* IFD filter:

In the cooling/heating/fan mode, if you press down the PURIFY button of the remote controller, the dust removal filter will slide to the working position within three minutes and start purifying. In the smart operation mode, the product will determine whether the purifying function needs to be turned on or not automatically according to the PM2.5 concentration value actually detected by the indoor air quality sensor. If yes, then the purifying function will turn on automatically. When the PM2.5 concentration drops to a certain value, the purifying function will turn off automatically and you do not need to press the remote controller.

Exit method:

1. While the air conditioner is operating in the purifying mode, if you press down the PURIFY button, then the purifying function will be cancelled and the dust removal filter will slide back its original position.

Matters needing attention:

1. Users can set whether to turn on the automatic purifying mode through the APP.
5. When the purifying function is turned on, due to the sliding of the dust removal filter, slight noise may be generated and this is a normal phenomenon.
6. If the air quality indicator light still shows red after the purifying has been operated for a long time period, we recommend you to replace and clean the dust removal filter.
7. In the purifying mode, low fan speed operation will affect the purifying effects.
8. You cannot enter the purifying mode from the self-cleaning mode directly.
9. The purifying module of this product has transmission mechanism, so please do not switch on and off the purifying

* NOTE:

IFD or HEPA filter depend on which product you bought.

Operation

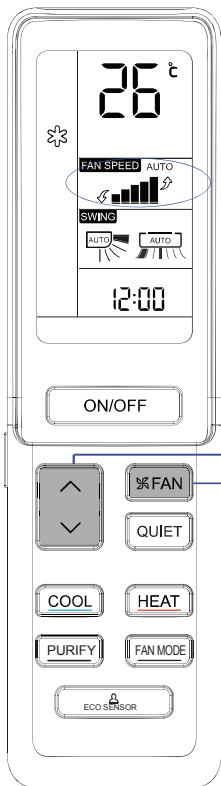

- 1 Press **TEMP** button.
 △ Every time the button is pressed, temp. setting increases 0.5 °C.
 ▽ Every time the button is pressed, temp. setting decreases 0.5 °C.

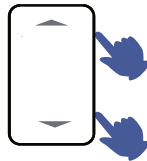

Unit will start running to reach the temp. setting on LCD.

2 FAN Operation



Press **FAN SPEED** button. For each press, fan speed changes as follows:

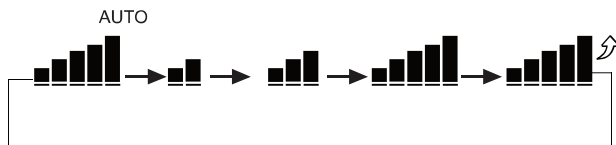

Unit will run at selected fan speed.



1 ECO SENSOR Operation

Press **ECO SENSOR** button, For each press, changes as follows:

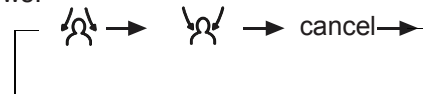

NOTE :

A human sensor is used to detect changes in the infrared radiation emitted by human bodies. In case of the following conditions, the detection may not be accurate:

- High room temperature, where the ambient temperature is close to body temperature.
- People wear a lot or lie on their stomach or back.
- The speed of human movement exceeds the sensitivity of the sensor.
- Frequent movements of pets, or frequent swing of curtains or other indoor objects due to the wind.
- Moving targets go beyond the detection range of the sensor.
- The left and right ends of the indoor unit are installed too close to the wall.
- There is direct sunlight inside the room.

The air conditioner operates in a room where ambient temperature fluctuates sharply.

Besides, if a person is at the border of two or three air blowing areas, the following air will be sent to these two areas respectively or be swept automatically. The avoiding air will avoid these two areas or be swept automatically.

Operation

FAN MODE Operation

English

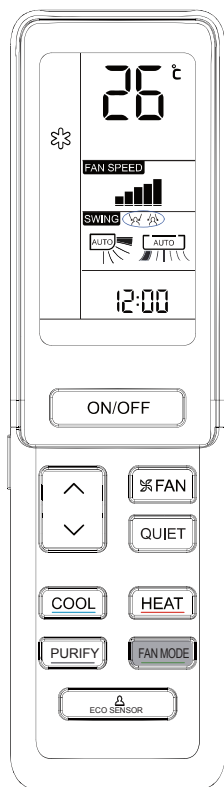

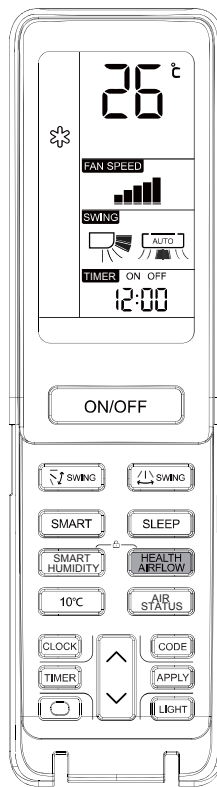

Fan mode: default low fan speed, fan mode, the setting temperature will not display, the temperature of indoor display is 24°C

HEALTH AIRFLOW Operation



The setting of health airflow function

- 1). Press the button of health airflow,  appears on the display. Avoid the strong airflow blows direct to the body.
- 2). Press the button of health airflow again,  appears on the display. Avoid the strong airflow blows direct to the body.



The cancel of the health airflow function



Press the button of health airflow again, both the inlet and outlet grilles of the air conditioner are opened, and the unit goes on working under the condition before the setting of health airflow function. After stopping, the outlet grille will close automatically.

Notice:

Cannot pull direct the outlet grille by hand. Otherwise, the grille will run incorrectly. If the grille is not run correctly, stop for a minute and then start, adjusting by remote controller.

Remote controller can memorize each operation status. when starting it next time, just press ON/OFF button and unit will run in previous status.

Note:

1. After setting the health airflow function, the position of inlet and outlet grilles is fixed.
2. In heating, it is better to select the  mode.
3. In cooling, it is better to select the  mode.
4. In cooling and dry, using the air conditioner for a long time under the high air humidity, a phenomenon falling drips of water occurs at the outlet grille.
5. Select the appropriate fan direction according to the actual conditions.

Operation

SWING Operation

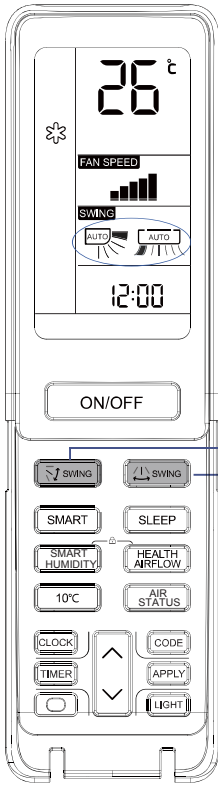

1 Up and down air flow direction

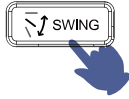

For each press of “” button, air flow direction on remote controller displays as follows according to different operation modes:

COOL/DRY:



HEAT:



SMART:



Initial state

2 Left and right air flow direction



For each press of “” button, remote controller displays as follows:

remote controller:

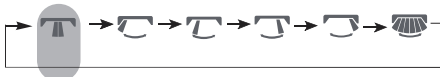

Initial state

- When humidity is high, condensate water might occur at air outlet if all vertical louvers are adjusted to left or right.
- It is advisable not to keep horizontal flap at downward position for a long time in COOL or DRY mode, otherwise, condensate water might occur.
- As cold air flows downward in COOL mode, adjusting air flow horizontally will be much more helpful for a

TIMER Operation

Set Clock correctly before starting Timer operation. You can let unit start or stop automatically a following times: Before you wake up in the morning, or get back from outside or after you fall asleep at night.

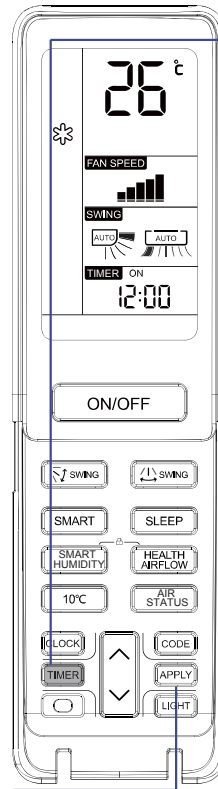

1 Select your desired operation mode.



Select your desired TIMER ON.

Remote controller: “TIMER ON” will flash.



Select your desired TIMER OFF.

Remote controller: “TIMER OFF” will flash.

2 Time setting.

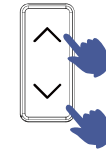

Every time the button is pressed, time setting increases or decreases

1 min, if kept depressed, it will increase rapidly. It can be adjusted within 24 hours.

3 Confirming your setting.



After setting correct time, press **APPLY** button to confirm “ON” or “OFF” on the remote controller stops flashing.

To cancel TIMER mode

Just press **TIMER** button several times until **TIMER** display disappear.

Operation

Comfortable SLEEP

Before going to bed, you can simply press the SLEEP button and unit will operate in SLEEP mode and bring you a sound sleep.

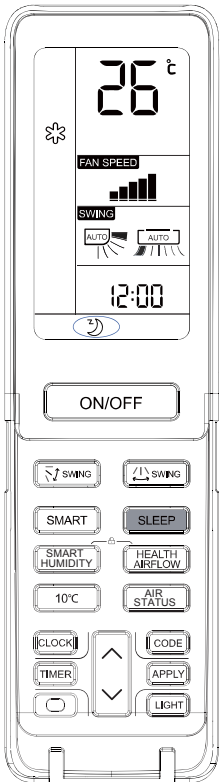

SLEEP

Press SLEEP button.

Operation Mode

1. In COOL, DRY mode

1 hours after SLEEP mode starts, temp. will become 1 °C higher than temp. setting. After another 1 hours, temp. rises by 1 °C further. The unit will run for further 6 hours then stops Temp. is higher than temp. setting so that room temperature won't be too low for your sleep.

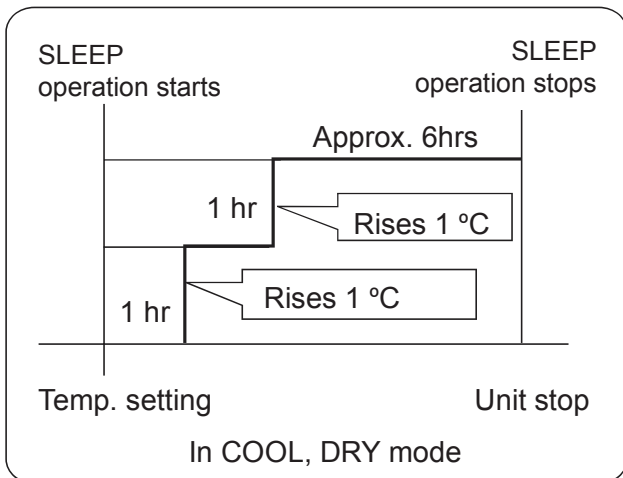

2. In HEAT mode

1 hours after SLEEP mode starts, temp will become 2 °C lower than temp. setting. After another 1 hours, temp decrease by 2 °C further. After more another 3 hours, temp. rises by 1 °C further. The unit will run for further

3 hours then stops. Temp. is lower than temp. setting so that room temperature won't be too high for your sleep.

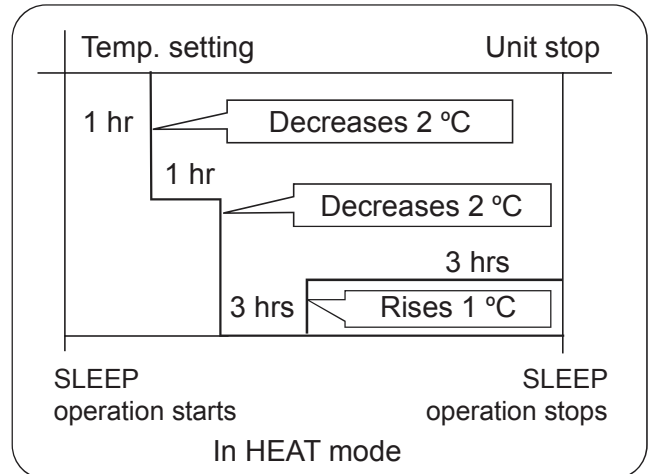

3. In SMART mode

The unit operates in corresponding sleep mode, which adapted to the automatically selected operation mode.

4. When quiet sleeping function is set to 8 hours the quiet sleeping time can not be adjusted. When TIMER function is set, the quiet sleeping function can't be set up. After the sleeping function is set up, if user resets TIMER function, the sleeping function will be cancelled; the machine will be in the state of timing-on, if the two modes are set up at the same time, either of their operation time is ended first, the unit will stop automatically, and the other mode will be cancelled.

Power Failure Resume Function

If the unit is started for the first time, the compressor will not start running unless 3 minutes have elapsed. When the power resumes after power failure, the unit will run automatically, and 3 minutes later the compressor starts running.

Note to the power failure resume:

press the sleep button ten times in five seconds and enter function after hearing four sounds. And press the sleep button ten times within five seconds and leave this function after hearing two sounds.

Operation

SMART Operation

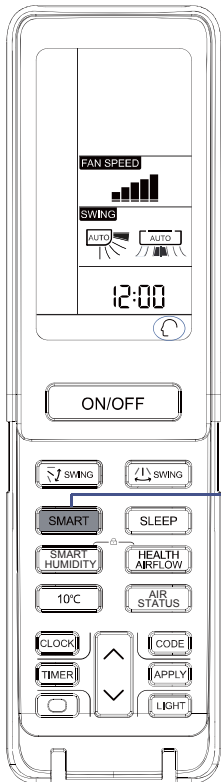

(This function is unavailable on some models)
One key can give you a comfortable room!
The air conditioning unit can judge the indoor temperature and humidity, and make the adjustment accordingly.

SMART SMART start

Press ON/OFF button, unit starts.
Press SMART button “” is displayed on the remote controller.

- SMART FRESH
- SMART Defrost
- SMART FAN SPEED
- SMART FAN HEALTH
- SMART DRY
- SMART SOFT
- SMART Control temperature

SMART or **ON/OFF** SMART stops

Under the cooling, heating and dehumidifying mode, press the smart key to enter the smart function. Under the smart running mode, when the air conditioning is running, it will automatically select cooling, heating, dehumidifying or blowing mode as When the smart function is running, press the “cooling” “heating” or “dehumidifying” key to switch to the other mode, you will exit from the smart function.

AIR STATUS and SMART HUMIDITY Operation

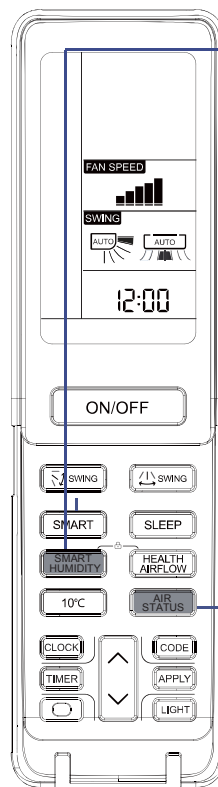

SMART HUMIDITY

Press SMART HUMIDITY button

In the **SMART Humidity** mode, the thermoregulation range is 16°C-30°C. When the fan speed is displayed as automatic (default initial state), it is smart humidity mode and the air conditioner regulates automatically and controls the relative humidity of the indoor environment within 40%-55%. If you manually adjust the fan speed to high/medium/low position, then the AC enters ordinary drying. If the fan speed is set to automatic, then the machine enters smart humidity mode again.

AIR STATUS

AIR STATUS function

If you press the button of query, the LCD display will show the temperature of the indoor environment.
If you press the button twice continuously, the LCD display will show the humidity value of the indoor air;
If you press the button three times continuously, the LCD display will show the PM2.5 concentration of the indoor air.
Note: Time intervals of continuous button pressing shall be less than 5s.

Loading of the battery

1

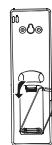

Remove the battery cover;

2



Load the batteries as illustrated. 2 R-03 batteries, resetting key (cylinder); Be sure that the loading is in line with the “+”/“-”;

3



Load the battery, then put on the cover again.

Operation -- Installation and removal of IFD/HEPA *

1. Brief introduction of the mechanism (the figure is the sketch of the parts, please refer to the real object)

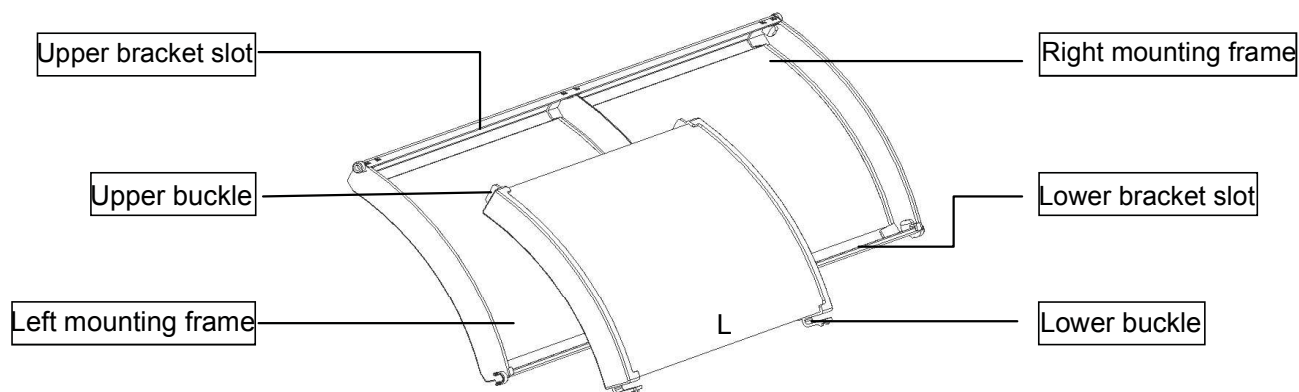

2. Install the filter element

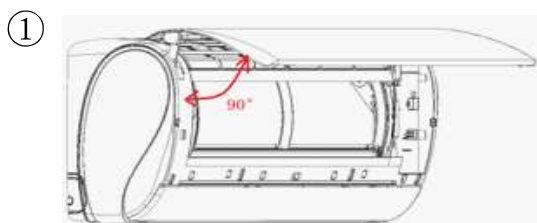

Unplug the power plug of the air conditioner, and open the panel upwards by about 90° (the panel will automatically get stuck).

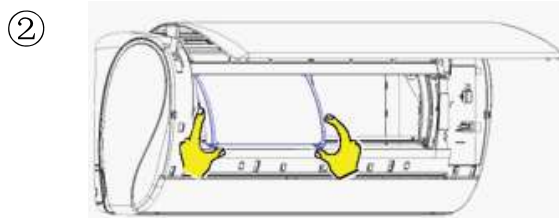

Snap the upper buckle of the filter element into the upper bracket slot and ensure that it is in place.

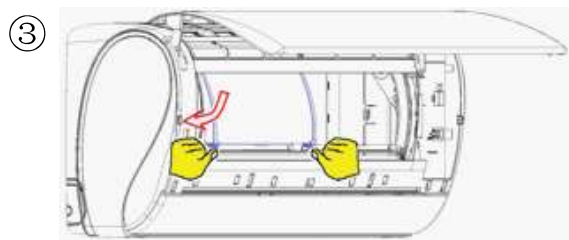

Snap the lower buckle of the filter element into the lower bracket slot and ensure that the buckle is in place.

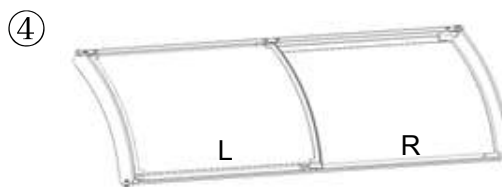

Install the other filter element in the right frame according to the operating steps ② and ③; Check and make sure that the filter element is flush with the arc surface of the mounting frame.

3. Remove the filter element

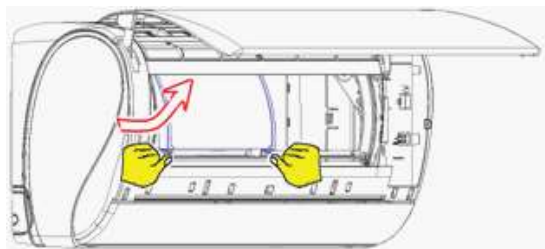

Turn the lower buckle of the filter element by hand to make the buckle out of the slot, rotate it in the direction shown in the figure and pull the filter element out.

* Note: Before the installation and removal of the dust removal filter element, the air conditioner should exit the purification state and shut down after 5 minutes to replace the filter element. Do not cut off the power supply directly and replace the filter element when the air conditioner is in the process of purification.

The operating steps of the filter element on the right are the same as those of the filter element on the left.

The IFD filter elements include a left one and a right one (L/R), while the HEPA filter elements can be left and right;

IFD or HEPA filter depend on which product you bought

Operation

Care and cleaning of IFD dust removal module

IFD dust removal module can be used all the time, generally does not need to be replaced, and can be washed. According to the actual conditions of the air conditioner, just clean it by yourself or when prompted by the APP. Additionally, clean the dust on the negative ion emitter on the right inner wall of the air duct with dry brush and other items.

When disassembling and cleaning the IFD module, cut off the power supply in advance, and wait 1 minute before removing the dust screen for cleaning!

1. Shut down the machine and switch off the power switch, hold the handle of the air inlet grilles to open them, and remove the dust screen;
2. Hold the handle on the IFD dust removal module and pull the module out;
3. After the dust removal module is taken out, place it on a flat surface and use the nozzle of the vacuum cleaner or the suction head with a brush to clean the dust along the surface of the module. Suck both sides of the module.
4. Add warm water in a basin and gently shake the module in the water to clean it.
5. Let the module soak in water for 2-3 minutes, do not take soak it for a too long time, then rinse the module with clean tap water, shake off the water in the module, and place it on a dry towel.
6. After the IFD dust removal module becoming completely dry and without water, load it into the machine, and then install the dust screen.

Notes:

1. After installation of the air conditioner, the installer shall load the IFD dust removal module into the air conditioner.
2. After cleaning, color of the module cannot restore to its original condition, but this will not affect its performance.
3. Dust removal effects of IFD relate closely to the room structure, room size and pollutants content in the room. The effects may vary depending on different models and environments.
4. IFD dust removal module must be installed in place before operation of the machine. It is prohibited to operate the machine without installing the dust removal module.

5. The filter is recommended to be replaced every 12 months under general indoor conditions and every 6 months under harsh indoor conditions so as to guarantee the purifying effects.

The dust removal filter shall be snapped into place during installation. If the clip is not fully snapped in, abnormal sliding of the dust removal filter and damage to the model may occur.

ON/OFF operation and test operation

ON/OFF Operation:

- Use this operation only when the remote controller is defective or lost, and with function of emergency running, air conditioner can run automatically for a while.
- When the emergency operation switch is pressed, the "Pi" sound is heard once, which means the start of this operation.
- When power switch is turning on for the first time and emergency operation starts, the unit will run automatically in the following modes:

Room temperature	Designated temperature	Timer mode	Fan speed	Operation mode
Above 24 °C	24 °C	No	AUTO	COOL
Below 24 °C	24 °C	No	AUTO	HEAT

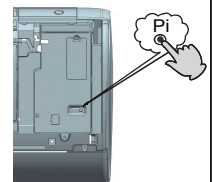

- It is impossible to change the settings of temp. and fan speed, It is also not possible to operate in timer or dry mode.

Test operation:

Test operation switch is the same as emergency switch.

- Use this switch in the test operation when the room temperature is below 16 °C, do not use it in the normal operation.
- Continue to press the test operation switch for more than 5 seconds. After you hear the "Pi" sound twice, release your finger from the switch: the cooling operation starts with the air flow speed "Hi".

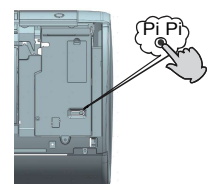

Care and cleaning of HEPA dust removal module

1. This model can only use the original dust filter specially designed by Haier for this product;
2. Be sure to remove the power plug before replacing and cleaning the dust removal filter;
3. Do not wash the dust removal filter with water;
4. This product is accompanied by dust removal filter when delivered. The first-time installation shall be carried out by the after-sales staff during installation of the air conditioner; for later replacement, you may buy the filter through the official Haier mall and shopping platform.

Operation

Steri Clean Operation

When the 56 °C Steri-clean function is required, please access in the hOn APP.

Introduction to Steri Clean

Stage 1 - Self Clean: to remove dirt away this function freezes the evaporator with moisture in the air, and removes dirt during the melting process. The hydrophilic aluminium coating with smaller angle ($\alpha \approx 5^\circ$) helps increase water drainage efficiency.)

Stage 2 - 56 °C high temperature sterilisation: It utilizes smart temperature monitoring and frequency control technology to adjust the compressor operation, so that we maintain the evaporator temperature at high temperature for over 30mins to kill any bacteria and virus inside the air conditioner.

Stage 3 - Rapid evaporator cooling to enhance the sterilisation performance. The foil surface is coated with silver nano-particles which has an anti-bacterial efficiency up to 99%.

Attention:

1. The function lasts 60-80 minutes.
2. Hot air may come out during the process when evaporator is heated to 56 °C or maintains at 56 °C in summer.
3. This function may cause changes in room air temperature in winter.
4. When outdoor ambient temperature is above 36 °C, the function cannot be performed. Instead, Self Clean function will be turned on and lasts 21mins when Steri Clean is turned on.

SELF-CLEAN Operation

◆ Functional description:

the purpose of this function is to clean the evaporator.

◆ Entry and exit:

If this function is needed, please select in the hOn APP.

Press SELF CLEAN button to enter this function. The display will show "CL" on the panel of the indoor unit and on the remote controller. Maximum running time in this function is no more than 21 minutes. This function will exit automatically with the " Pi " sound twice, then the unit return to original state. During SELF CLEAN operation, pressing the button repeatedly will not exit the process. Press the "power" button to exit this mode.

◆ Note:

1. This function is invalid in timer / sleep mode.
2. After this mode starts, the air volume may reduce, have no airflow, or even cold airflow blowing.
3. It is normal if the unit make some sound when the air expands with heat and contract with cold.
4. The "CL" display time may last differently on the remote controller and panel.
5. If the outside ambient temperature is below zero, error code "F25" may be show up during self-cleaning operation, which is normal protection, please turn off the power and restart after 10 seconds .
6. The best condition to run this mode, is when the temperature is 20 °C ~ 27 °C and the humidity is 35% ~ 60% indoors, the temperature is 25 °C ~ 38 °C (cooling season) outdoors.
7. It is hard for the air to frost if the air is too dry (humidity < 20%). and if the humidity is too high (humidity > 70%) the condensate water may increase.

IMPORTANT INFORMATION REGARDING THE REFRIGERANT USED

Contains fluorinated greenhouse gases covered by the Kyoto Protocol		A
R32	1= <input type="text"/> kg	B
2	2= <input type="text"/> kg	C
1+2	1+2= <input type="text"/> kg	D
F E		

This product contains fluorinated greenhouse gases covered by the Kyoto Protocol. Do not vent into the atmosphere.

Refrigerant type: R32

GWP* value: 675

GWP=global warming potential

Please fill in with indelible ink,

- 1 the factory refrigerant charge of the product
- 2 the additional refrigerant amount charged in the field and
- 1+2 the total refrigerant charge

on the refrigerant charge label supplied with the product.

The filled out label must be adhered in the proximity of the product charging port (e.g. onto the inside of the stop value cover).

A contains fluorinated greenhouse gases covered by the Kyoto Protocol

B factory refrigerant charge of the product: see unit name plate

C additional refrigerant amount charged in the field

D total refrigerant charge

E outdoor unit

F refrigerant cylinder and manifold for charging

EUROPEAN REGULATIONS CONFORMITY FOR THE MODELS

Climate: T1 Voltage: 230V

CE

All the products are in conformity with the following European provision:

- 2014/53/EU (RED)
- 2014/517/EU (F-GAS)
- 2009/125/EC (ENERGY)
- 2010/30/EU (ENERGY)
- 2006/1907/EC (REACH)

ROHS

The products are fulfilled with the requirements in the directive 2011/65/EU of the European parliament and of council on the Restriction of the use of Certain Hazardous Substances in Electrical and Electronic Equipment (EU RoHS Directive)

WEEE

In accordance with the directive 2012/19/EU of the European parliament, herewith we inform the consumer about the disposal requirements of the electrical and electronic products.

DISPOSAL REQUIREMENTS:



Your air conditioning product is marked with this symbol. This means that electrical and electronic products shall not be mixed with unsorted household waste. Do not try to dismantle the system yourself: the dismantling of the air conditioning system, treatment of the refrigerant, of oil and of other part must be done by a qualified installer in accordance with relevant local and national legislation. Air conditioners must be treated at a specialized treatment facility for reuse, recycling and recovery. By ensuring this product is disposed of correctly, you will help to prevent potential negative consequences for the environment and human health. Please contact the installer or local authority for more information. Battery must be removed from the remote controller and disposed of separately in accordance with relevant local and national legislation.

Wi-Fi

- Wireless maximum transmit power (20dBm)
- Wireless operating frequency range (2400~2483.5MHz)
- Support standards: IEEE 802.11b, IEEE 802.11g, IEEE 802.11n

Indoor Unit Installation

Necessary Tools for Installation

- Driver
- Nipper
- Hacksaw
- Hole core drill
- Spanner(17,19 and 26mm)
- Gas leakage detector or soap-and-water solution
- Torque wrench (17mm,22mm,26mm)
- Pipe cutter
- Flaring tool
- Knife
- Measuring tape
- Reamer

Power Source

- Before inserting power into receptacle, check the voltage without fail.
- The power supply is the same as the corresponding nameplate.
- Install an exclusive branch circuit of the power.
- A receptacle shall be set up in a distance where the power cable can be reached. Do not extend the cable by cutting it.

Selection of Installation Place

- Place, robust not causing vibration, where the body can be supported sufficiently.
- Place, not affected by heat or steam generated in the vicinity, where inlet and outlet of the unit are not disturbed.
- Place, possible to drain easily, where piping can be connected with the outdoor unit.
- Place, where cold air can be spread in a room entirely.
- Place, nearby a power receptacle, with enough space around.
- Place where the distance of more than 1m from televisions, radios, wireless apparatuses and fluorescent lamps can be left.
- In the case of fixing the remote controller on a wall, place where the indoor unit can receive signals when the fluorescent lamps in the room are lightened.

Selection of Pipe

FOR 09K 12K	Liquid pipe	φ 6.35x0.8mm
	Gas pipe	φ 9.52x0.8mm
FOR 18K	Liquid pipe	φ 6.35x0.8mm
	Gas pipe	φ 12.7x0.8mm
FOR 24K	Liquid pipe	φ 9.52x0.8mm
	Gas pipe	φ 15.88x1.0mm

Drawing for the installation of indoor units

The models adopt HFC free refrigerant R32

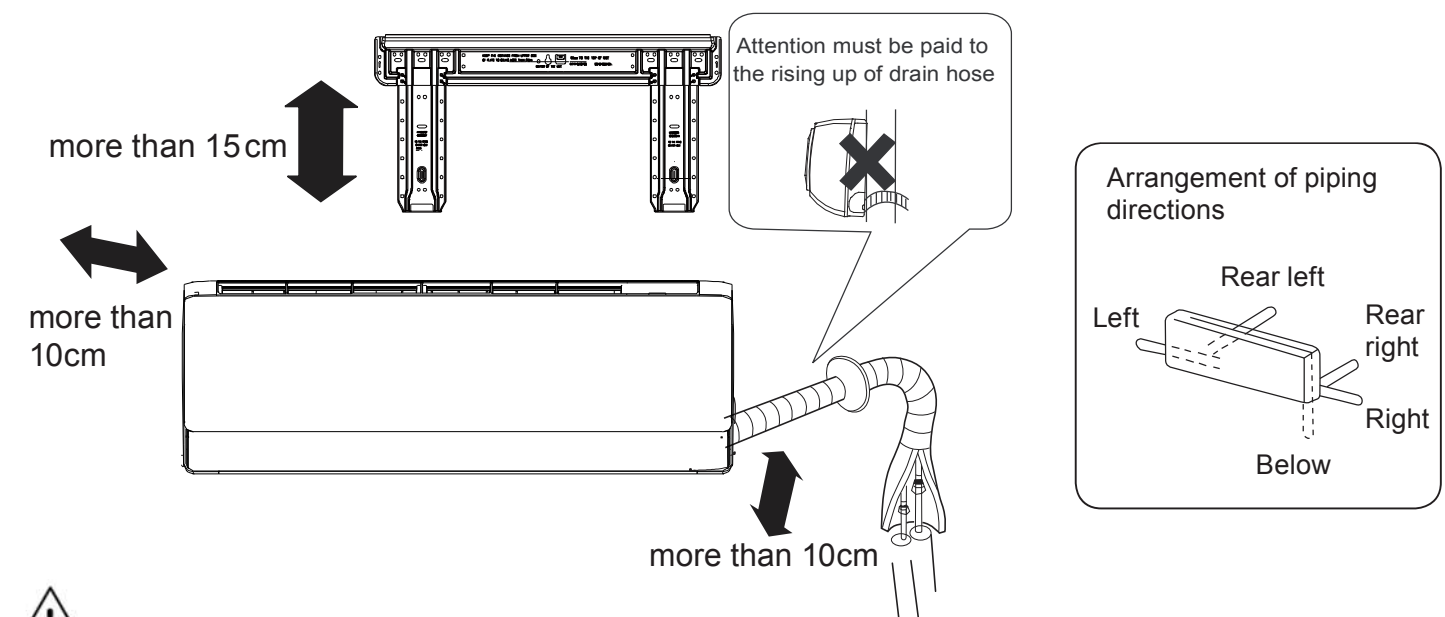

If using the left side drain pipe, make sure the hole is got through.
The distance between the indoor unit and the floor should be more than 2m.
Please be subject to the actual product purchased, the above picture is just for your reference.

Indoor Unit Installation

1 Fitting of the Mounting Plate and Positioning of the wall Hole

When the mounting plate is first fixed

1. Carry out, based on the neighboring pillars or lintels, a proper leveling for the plate to be fixed against the wall, then temporarily fasten the plate with one steel nail.
2. Make sure once more the proper level of the plate, by hanging a thread with a weight from the central top of the plate, then fasten securely the plate with the attachment steel nail.
3. Find the wall hole location A/C using a measuring tape

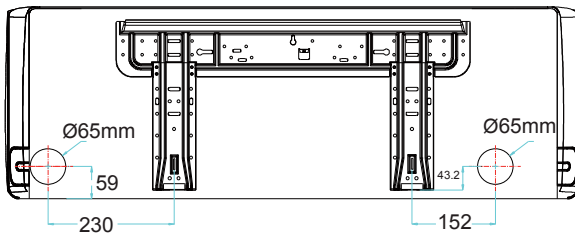
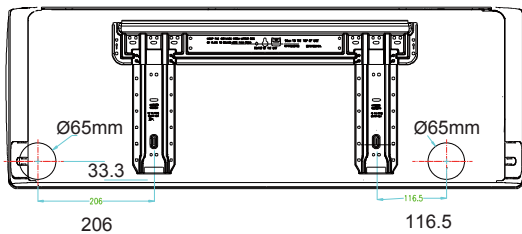

When the mounting plate is fixed side bar and lintel

- Fix to side bar and lintel a mounting bar, which is separately sold, and then fasten the plate to the fixed mounting bar.
- Refer to the previous article, "When the mounting plate is first fixed", for the position of wall hole.

2 Making a Hole on the Wall and Fitting the Piping Hole Cover

- Make a hole of 60 mm in diameter, slightly descending to outside the wall
- Install piping hole cover and seal it off with putty after installation

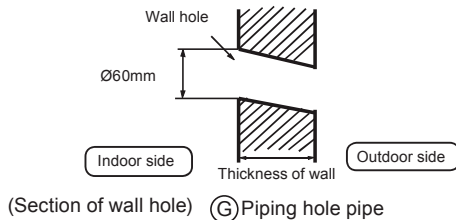

3 Installation of the Indoor Unit

Drawing of pipe

[Rear piping]

- Draw pipes and the drain hose, then fasten them with the adhesive tape

[Left • Left-rear piping]

- In case of left side piping, cut away, with a nipper, the lid for left piping.
- In case of left-rear piping, bend the pipes according to the piping direction to the mark of hole for left-rear piping which is marked on heat insulation materials.

1. Insert the drain hose into the dent of heat insulation materials of indoor unit.
2. Insert the indoor/outdoor electric cable from backside of indoor unit, and pull it out on the front side, then connect them.
3. Coat the flaring seal face with refrigerant oil and connect pipes. Cover the connection part with heat insulation materials closely, and make sure fixing with adhesive tape

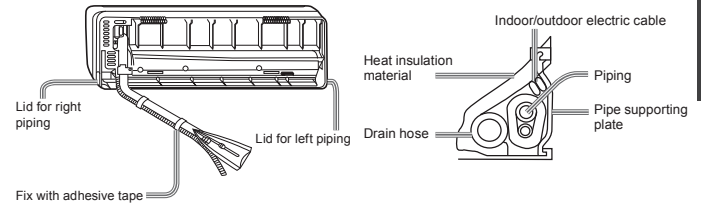

- Indoor/outdoor electric cable and drain hose must be bound with refrigerant piping by protecting tape.

[Other direction piping]

- Cut away, with a nipper, the lid for piping according to the piping direction and then bend the pipe according to the position of wall hole. When bending, be careful not to crush pipes.
- Connect beforehand the indoor/outdoor electric cable, and then pull out the connected to the heat insulation of connecting part specially.

Fixing the indoor unit body

- Hang surely the unit body onto the upper notches of the mounting plate. Move the body from side to side to verify its secure fixing.
- In order to fix the body onto the mounting plate, hold up the body aslant from the underside and then put it down perpendicularly. mounting plate

Unloading of indoor unit body

- When you unload the indoor unit, please use your hand to arise the body to leave agraffe, then lift the bottom of the body outward slightly and lift the unit aslant until it leaves the mounting plate.

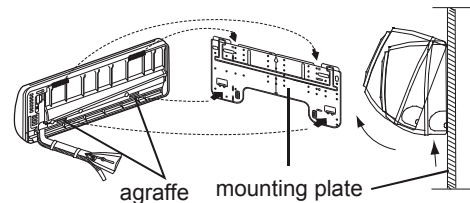

4 Connecting the indoor/outdoor Electric Cable

Removing the wiring cover

- Remove terminal cover at right bottom corner of indoor unit, then take off wiring cover by removing its screws.

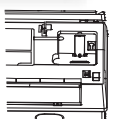

When connecting the cable after installing the indoor unit

1. Insert from outside the room cable into left side of the wall hole, in which the pipe has already existed.
2. Pull out the cable on the front side, and connect the cable making a loop.

When connecting the cable before installing the indoor unit

- Insert the cable from the back side of the unit, then pull it out on the front side.
- Loosen the screws and insert the cable ends fully into terminal block, then tighten the screws.
- Pull the cable slightly to make sure the cables have been properly inserted and tightened.
- After the cable connection, never fail to fasten the connected cable with the wiring cover.

English

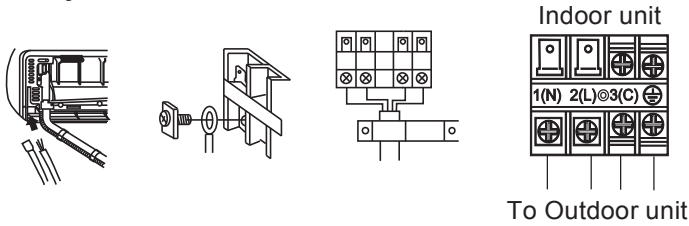

Note:

When connecting the cable, confirm the terminal number of indoor and outdoor units carefully. If wiring is not correct, proper operation can not be carried out and will cause defect.

Connecting wiring

AS25S2SJ1FA-3 AS35S2SJ1FA-3 AS50S2SJ1FA-3	≥ 4G1.0mm ²
---	------------------------

1. If the supply cord is damaged, it must be replaced by the manufacturer or its service agent or a similar qualified person. The type of connecting wire is H05RN-F or H07RN-F.
2. If the fuse on PC board is broken please change it with the type of T.3.15A/250VAC (Indoor).
3. The wiring method should be in line with the local wiring standard.
4. After installation, the power plug should be easily reached.
5. A breaker should be incorporated into fixed wiring. The breaker should be all-pole switch and the distance between its two contacts should be not less than 3mm.

5 Power Source Installation

- The power source must be exclusively used for air conditioner.
- In the case of installing an air conditioner in a moist place, please install an earth leakage breaker.
- For installation in other places, use a circuit breaker as far as possible.

6 Cutting and Flaring Work of Piping

- Pipe cutting is carried out with a pipe cutter and burs must be removed.
- After inserting the flare nut, flaring work is carried out.

Flare tool for R410A	Conventional flare tool	
	Clutch-type	clutch-type(Rigid-type) Wing-nut type (Imperial-type)
A	0~0.5mm	1.0~1.5mm 1.5~2.0mm

Flare tooling die

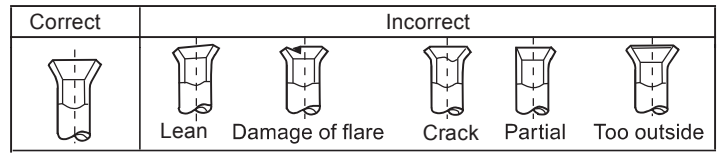
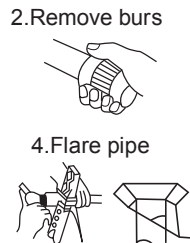
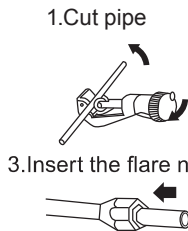
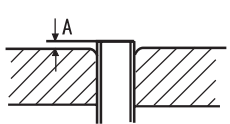

7 On Drainage

- Please install the drain hose so as to be downward slope without fail.
- Please don't do the drainage as shown below.

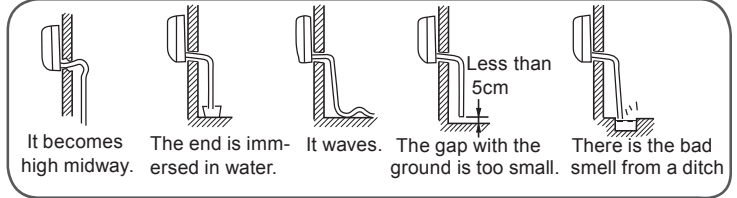

- Please pour water in the drain pan of the indoor unit, and confirm that drainage is carried out surely to outdoor.
- In case that the attached drain hose is in a room, please apply heat insulation to it without fail.

8 On Drainage

Code indication	Trouble description	Analyze and diagnose
E1	Room temperature sensor failure	Faulty connector connection; Faulty thermistor; Faulty PCB;
E2	Heat-exchange sensor failure	
E4	Indoor EEPROM error	Faulty EEPROM data; Faulty EEPROM; Faulty PCB;
E7	Communication fault between indoor and outdoor units	Indoor unit- outdoor unit signal transmission error due to wiring error; Faulty PCB;
E14	Indoor fan motor malfunction	Operation halt due to breaking of wire inside the fan motor; Operation halt due to breaking of the fan motor lead wires; Detection error due to faulty indoor unit PCB;

9 Check for Installation and Test Run

- Please kindly explain to our customers how to operate through the instruction manual.







Check Items for Test Run

Put check mark ✓ in boxes

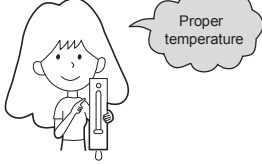
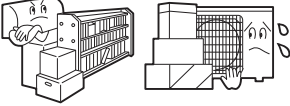
- Gas leak from pipe connecting?
- Heat insulation of pipe connecting?
- Are the connecting wirings of indoor and outdoor firmly inserted to the terminal block?
- Is the connecting wiring of indoor and outdoor firmly fixed?
- Is drainage securely carried out?
- Is the earth line securely connected?
- Is the indoor unit securely fixed?
- Is power source voltage abided by the code?
- Is there any noise?
- Is the lamp normally lighting?
- Are cooling and heating (when in heat pump) performed normally?
- Is the operation of room temperature regulator normal?

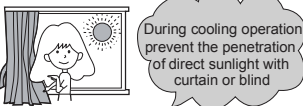
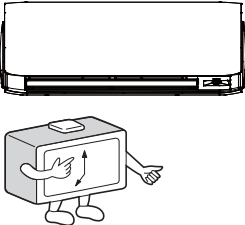

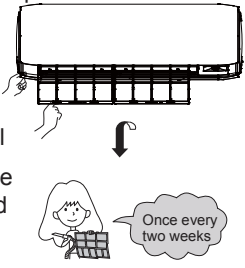

Maintenance

For Smart Use of The Air Conditioner

<p>Setting of proper room temperature</p> 	<p>Do not block the air inlet or outlet</p> 	<p>Remote Controller</p>  <p>Do not use water, wipe the controller with a dry cloth. Do not use glass cleaner or chemical cloth.</p>	<p>Indoor Body</p>  <p>wipe the air conditioner by using a soft and dry cloth. For serious stains, use a neutral detergent diluted with water. Wring the water out of the cloth before wiping, then wipe off the detergent completely.</p>
<p>Close doors and windows during operation</p> 	<p>Use the timer effectively</p> 	<p>Do not use the following for cleaning</p>  <p>Gasoline, benzene, thinner or cleanser may damage the coating of the unit. Hot water over 40°C (104°F) may cause discoloring or deformation.</p>	
<p>If the unit is not to be used for a long time, turn off the power supply main switch.</p> 	<p>Use the louvers effectively</p> 	<p>Air Filter cleaning</p> <ol style="list-style-type: none"> 1 Press the "SMART" button for 5s to partially raise the panel. 2 Open the panel by hand and support the panel with a holder 3 Remove the filter 4 Clean the filter 5 Fit the filter 6 Remove the holder and close the panel 7 Long press the "SMART" button and the panel will automatically lower down and become closed  <p>Once every two weeks</p>	

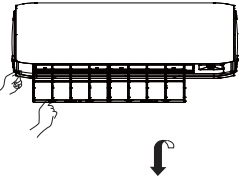
English

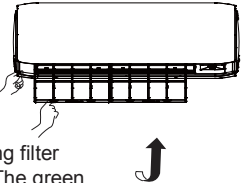
Replacement of Air Purifying Filter

<p>1. Open the Inlet Grille</p> <p>Press the "SMART" button for 5s to partially raise the panel.</p>  <p>2. Detach the standard air filter</p> <p>Slide the knob slightly upward to release the filter, then withdraw it.</p>  <p>Detach old Air Purifying Filter</p> 	<p>4. Attach the standard air filter (Necessary installation)</p> <p>ATTENTION:</p> <p>The white side of the photocatalyst air purifying filter face outside, and the black side face the unit. The green side of the bacteria-killing medium air purifying filter face outside, and the white side face the unit.</p>  <p>5. Close the Inlet Grille</p> <p>Long press the "SMART" button and the panel will automatically lower down and become closed.</p> <p>NOTE:</p> <ul style="list-style-type: none"> • The photocatalyst air purifying filter will be solarized in fixed time. In normal family, it will be solarized every 6 months. • The bacteria-killing medium air purifying filter will be used for a long time, no need for replacement. But in the period of using them, you should remove the dust frequently by using vacuum cleaner or flapping them lightly, otherwise, its performance will be affected. • Please keep the bacteria-killing medium air purifying filter in the cool and dry conditions avoid long time directly sunshine when you stop using it, or its ability of sterilization will be reduced.
<p>3. Attach Air Purifying Filter</p> <p>Put air purifying filter appliances into the right and left filter frames.</p> 	

Cautions

English

⚠ WARNING

Please call Sales/Service Shop for the Installation.

Do not attempt to install the air conditioner by yourself because improper works may cause electric shock, fire, water leakage.

⚠ WARNING

When abnormality such as burnt-smell found, immediately stop the operation button and contact sales shop.

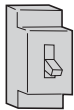

OFF



STRICT ENFORCEMENT

Use an exclusive power source with a circuit breaker

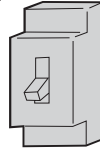

Check proper installation of the drainage securely



STRICT ENFORCEMENT

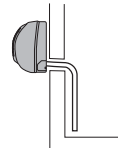

Connect power supply cord to the outlet completely



STRICT ENFORCEMENT

Use the proper voltage



STRICT ENFORCEMENT

1. Do not use power supply cord extended or connected in halfway
2. Do not install in the place where there is any possibility of inflammable gas leakage around the unit.
3. Do not get the unit exposed to vapor or oil steam.



PROHIBITION

Do not use power supply cord in a bundle.

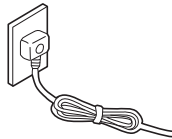

PROHIBITION

Take care not to damage the power supply cord.

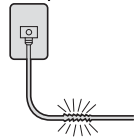

PROHIBITION

Do not insert objects into the air inlet or outlet.



PROHIBITION

Do not start or stop the operation by disconnecting the power supply cord and so on.

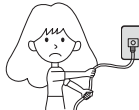

PROHIBITION

Do not channel the air flow directly at people, especially at infants or the aged.



PROHIBITION

Do not try to repair or reconstruct by yourself.

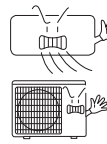

Connect the earth cable.

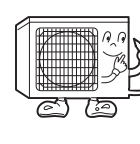

earthing

⚠ CAUTION

Do not use for the purpose of storage of food, art work, precise equipment, breeding, or cultivation.



PROHIBITION

Take fresh air occasionally especially when gas appliance is running at the same time.

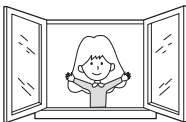

STRICT ENFORCEMENT

Do not operate the switch with wet hand.

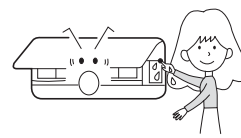

PROHIBITION

Do not install the unit near a fireplace or other heating apparatus.

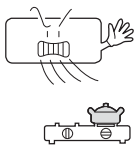

PROHIBITION

Check good condition of the installation stand

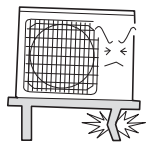

PROHIBITION

Do not pour water onto the unit for cleaning

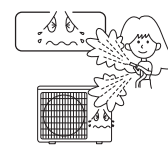

PROHIBITION

Do not place animals or plants in the direct path of the air flow

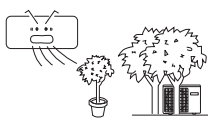

PROHIBITION

Do not place any objects on or climb on the unit.



PROHIBITION





Do not place flower vase or water containers on the top of the unit.



PROHIBITION

Trouble shooting

Before asking for service, check the following first.

	Phenomenon	Cause or check points
Normal Performance inspection	The system does not restart immediately. 	<ul style="list-style-type: none"> When unit is stopped, it won't restart immediately until 3 minutes have elapsed to protect the system. When the electric plug is pulled out and reinserted, the protection circuit will work for 3 minutes to protect the air conditioner.
	Noise is heard 	<ul style="list-style-type: none"> During unit operation or at stop, a swishing or gurgling noise may be heard. At first 2-3 minutes after unit start, this noise is more noticeable. (This noise is generated by refrigerant flowing in the system.) During unit operation, a cracking noise may be heard. This noise is generated by the casing expanding or shrinking because of temperature changes. Should there be a big noise from air flow in unit operation, air filter may be too dirty.
	Smells are generated.	<ul style="list-style-type: none"> This is because the system circulates smells from the interior air such as the smell of furniture, paint, cigarettes.
	Mist or steam are blown out. 	<ul style="list-style-type: none"> During COOL or DRY operation, indoor unit may blow out mist. This is due to the sudden cooling of indoor air.
	In dry mode, fan speed can't be changed.	<ul style="list-style-type: none"> In DRY mode, when room temperature becomes lower than temp. setting+2 °C, unit will run intermittently at LOW speed regardless of FAN setting.
Multiple check		<ul style="list-style-type: none"> Is power plug inserted? Is there a power failure? Is fuse blownout?
	Poor cooling 	<ul style="list-style-type: none"> Is the air filter dirty? Normally it should be cleaned every 15 days. Are there any obstacles before inlet and outlet? Is temperature set correctly? Are there some doors or windows left open? Is there any direct sunlight through the window during the cooling operation?(Use curtain) Are there too much heat sources or too many people in the room during cooling operation?

Cautions

- Do not obstruct or cover the ventilation grille of the air conditioner. Do not put fingers or any other things into the inlet/outlet and swing louver.
- This appliance is not intended for use by persons (including children) with reduced physical, sensory or mental capabilities or lack of experience and knowledge, unless they have been given supervision or instruction concerning use of appliance by person responsible for their safety. Children should be supervised to ensure that they do not play with the appliance.

Specifications

- The refrigerating circuit is leak-proof.

The machine is adaptive in following situation

1. Applicable ambient temperature range:

Cooling	Indoor	Maximum: D.B/W.B 32°C/23°C Minimum: D.B/W.B 21°C/15°C
	Outdoor	Maximum: D.B/W.B 46°C/26°C Minimum: D.B -20°C
Heating	Indoor	Maximum: D.B 27°C Minimum: D.B 15°C
	Outdoor	Maximum: D.B/W.B 24°C/18°C Minimum: D.B/W.B -7°C/-8°C
	Outdoor (INVERTER)	Maximum: D.B/W.B 24°C/18°C Minimum: D.B -30°C

- If the power supply cord is damaged, it must be replaced by the manufacturer or its service agent or a similar qualified person.
- If the fuse of indoor unit on PC board is broken, please change it with the type of T. 3.15A/ 250V. If the fuse of outdoor unit is broken, change it with the type of T.25A/250V
- The wiring method should be in line with the local wiring standard.
- After installation, the power plug should be easily reached.
- The waste battery should be disposed properly.
- The appliance is not intended for use by young children or infirm persons without supervision.
- Young children should be supervised to ensure that they do not play with the appliance.
- Please employ the proper power plug, which fit into the power supply cord.
- The power plug and connecting cable must have acquired the local attestation.
- In order to protect the units, please turn off the A/C first, and at least 30 seconds later, cutting off the power.

Haier

Address: No.1 Haier Road, Hi-tech Zone, Qingdao 266101 P.R.China

Contacts: TEL +86-532-8893-7937

Website: www.haierhvac.eu