

DUCT TYPE AIR CONDITIONER OPERATION MANUAL AND INSTALLATION MANUAL

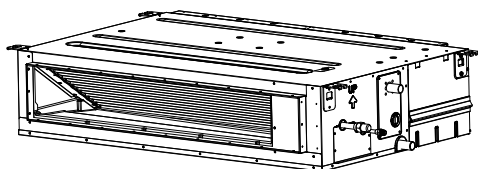

AD90S2SM3FA
AD90S2SM4FA

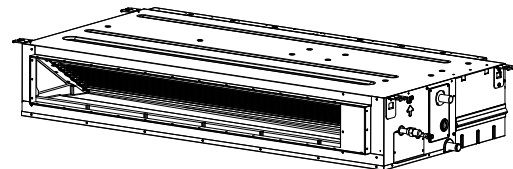

AD105S2SM3FA
AD105S2SM4FA
AD125S2SM3FA
AD125S2SM4FA
AD140S2SM3FA
AD140S2SM4FA

Contents

Cautions	3
Safety Precautions	4
Parts and Functions	6
Installation Manual For Wire Controller	7
Heating Mode	8
Care and Maintenance	9
Troubleshooting	10
Precaution for Installation	14
Is The Unit Installed Correctly	15
Installation Procedure	16
Move and scrap the air conditioning	21

0150528612

- This product must only be installed or serviced by qualified personnel.
Please read this manual carefully before installation.
Keep this operation manual for future reference.
Original instructions

Haier

Haier Industrial Park, No.1 Haier road, Qingdao,P.R.China

EUROPEAN REGULATIONS CONFORMITY FOR THE MODELS

CE

All the products are in conformity with the following European provision:

- Low voltage Directive
- Electromagnetic Compatibility

ROHS

The products are fulfilled with the requirements in the directive 2011/65/EU of the European parliament and of council on the Restriction of the use of Certain Hazardous Substances in Electrical and Electronic Equipment(EU RoHS Directive)

WEEE

In accordance with the directive 2012/19/EU of the European parliament,herewith we inform the consumer about the disposal requirements of the electrical and electronic products.

DISPOSAL REQUIREMENTS:



Your air conditioning product is marked with this symbol.This means that electrical and electronic products shall not be mixed with unsorted household waste.Do not try to dismantle the system yourself:the dismantling of the air

conditioning system,treatment of the refrigerant,of oil and of other part must be done by a qualified installer in accordance with relevant local and national legislation.Air conditioners must be treated at a specialized treatment facility for reuse, recycling and recovery.By ensuring this product is disposed of correctly,you will help to prevent potential negative consequences for the environment and humen health.Please contact the installer or local authority for more information. Battery must be removed from the remote controller and disposed of separately in accordance with relevant local and nationl legislation.

IMPORTANT INFORMATION REGARDING THE REFRIGERANT USED

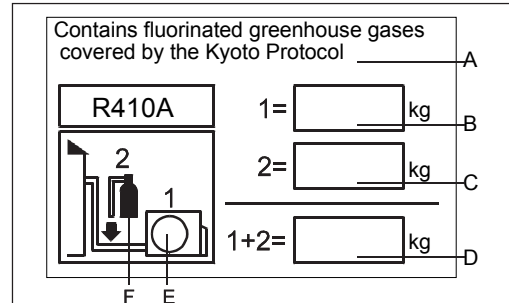

This product contains fluorinated greenhouse gases covered by the Kyoto Protocol.Do not vent into the atmosphere.

GWP:2088

Refrigerant type:R410A

GWP=global warming potential

Please fill in with indelible ink,

- 1 the factory refrigerant charge of the product
- 2 the additional refrigerant amount charged in the field and

• 1+2 the total refrigerant charge

on the refrigerant charge label supplied with the product.

The filled out label must be adhered in the proximity of the product charging port(e.g.onto the inside of the stop value cover).

A contains fluorinated greenhouse gases covered by the Kyoto Protocol

B factory refrigerant charge of the product:see unit name plate

C additional refrigerant amount charged in the field

D total refrigerant charge

E outdoor unit

F refrigerant cylinder and manifold for charging

⚠ WARNING

If the supply cord is damaged, it must be replaced by the manufacturer, its service agent or similarly qualified persons in order to avoid a hazard.

This appliance is not intended for use by persons (including children) with reduced physical, sensory or mental capabilities, or lack of experience and knowledge, unless they have been given supervision or instruction concerning use of the appliance by a person responsible for their safety.

Children should be supervised to ensure that they do not play with the appliance.

This appliance can be used by children aged from 8 years and above and persons with reduced physical, sensory or mental capabilities or lack of experience and knowledge if they have been given supervision or instruction concerning use of the appliance in a safe way and understand the hazards involved. Children shall not play with the appliance. Cleaning and user maintenance shall not be made by children without supervision.

The appliances are not intended to be operated by means of an external timer or separate remote-control system.

Keep the appliance and its cord out of reach of children less than 8 years.

⚠ WARNING

Do not use means to accelerate the defrosting process or to clean, other than those recommended by the manufacturer.

The appliance must be stored in a room without continuously operating ignition sources (for examples: open flames, an operating gas appliance or an operating electric heater).

Do not pierce or burn.

Be aware that refrigerants may not contain an odour.

If the supply cord is damaged, it must be replaced by the manufacturer, its service agent or similarly qualified persons in order to avoid a hazard.

This appliance can be used by children aged 8 years and above and persons with reduced physical, sensory or mental capabilities or lack of experience and knowledge if they have been given supervision or instruction concerning use of the appliance in a safe way and understand the hazards involved. Children shall not play with the appliance. Cleaning and user maintenance shall not be made by children without supervision.

The wiring method should be in line with the local wiring standard.

All the cables shall have got the European authentication certificate. During installation, when the connecting cables break off, it must be assured that the grounding wire is the last one to be broken off. The explosion-proof breaker of the air conditioner should be all-pole switch. Distance between its two contacts should not be no less than 3mm. Such means for disconnection must be incorporated in the wiring.

Make sure installation is done according to local wiring regulation by professional persons.

Make sure ground connection is correct and reliable. A leakage explosion-proof breaker must be installed.

The installation and service of this product shall be carried out by professional personnel, who have been trained and certified by national training organizations that are accredited to teach the relevant national competency standards that may be set in legislation.

Mechanical connectors used indoors shall comply with ISO 14903. When mechanical connectors are reused indoors, sealing parts shall be renewed. When flared joints are reused indoors, the flare part shall be re-fabricated.

This appliance is intended to be used by expert or trained users in shops, in light industry and on farms, or for commercial use by lay persons.

Disconnect the appliance from its power source during service and when replacing parts

The maximum working pressure is 4.15 MPa. This maximum working pressure shall be considered when connecting the outdoor unit to indoor units.

The refrigerant suitable for the indoor unit is R410A. The indoor unit shall only be connected to outdoor unit suitable for the same refrigerant.

The unit is a partial unit air conditioner, complying with partial unit requirements of the International Standard, and must only be connected to other units that have been confirmed as complying to corresponding partial unit requirements of the International Standard.

The A-weighted sound pressure level is below 70 dB.

Cautions

Disposal of the old air conditioner

Before disposing an old air conditioner that goes out of use, please make sure it's inoperative and safe. Unplug the air conditioner in order to avoid the risk of child entrapment.

It must be noticed that air conditioner system contains refrigerants, which require specialized waste disposal. The valuable materials contained in a air conditioner can be recycled. Contact your local waste disposal center for proper disposal of an old air conditioner and contact your local authority or your dealer if you have any question. Please ensure that the pipework of your air conditioner does not get damaged prior to being picked up by the relevant waste disposal center, and contribute to environmental awareness by insisting on an appropriate, anti-pollution method of disposal.

Disposal of the packaging of your new air conditioner

All the packaging materials employed in the package of your new air conditioner may be disposed without any danger to the environment.

The cardboard box may be broken or cut into smaller pieces and given to a waste paper disposal service. The wrapping bag made of polyethylene and the polyethylene foam pads contain no fluorochloric hydrocarbon.

All these valuable materials may be taken to a waste collecting center and used again after adequate recycling.

Consult your local authorities for the name and address of the waste materials collecting centers and waste paper disposal services nearest to your house.

Safety Instructions and Warnings

Before starting the air conditioner, read the information given in the User's Guide carefully. The User's Guide contains very important observations relating to the assembly, operation and maintenance of the air conditioner.

The manufacturer does not accept responsibility for any damages that may arise due to non-observation of the following instruction.

- Damaged air conditioners are not to be put into operation. In case of doubt, consult your supplier.
- Use of the air conditioner is to be carried out in strict compliance with the relative instructions set forth in the User's Guide.
- Installation shall be done by professional people, don't install unit by yourself.
- For the purpose of safety, the air conditioner must be properly grounded in accordance with specifications.
- Always remember to unplug the air conditioner before opening inlet grill. Never unplug your air conditioner by pulling on the power cord. Always grip plug firmly and pull straight out from the outlet.
- All electrical repairs must be carried out by qualified electricians. Inadequate repairs may result in a major source of danger for the user of the air conditioner.
- Do not damage any parts of the air conditioner that carry refrigerant by piercing or perforating the air conditioner's tubes with sharp or pointed items, crushing or twisting any tubes, or scraping the coatings off the surfaces. If the refrigerant spurts out and gets into eyes, it may result in serious eye injuries.
- Do not obstruct or cover the ventilation grille of the air conditioner. Do not put fingers or any other things into the inlet/outlet and swing louver.
- Do not allow children to play with the air conditioner. In no case should children be allowed to sit on the outdoor unit.
- This appliance is not intended for use by persons (including children) with reduced physical, sensory or mental capabilities, or lack of experience and knowledge, unless they have been given supervision or instruction concerning use of the appliance by a person responsible for their safety.
- Children should be supervised to ensure that they do not play with the appliance.













Safety Precautions

- Before starting to use the system, read carefully this "SAFETY PRECAUTIONS" to ensure a proper operation of the system.
- Safety precautions described here are classified to " ⚠ WARNING" and " ⚠ CAUTION". Precautions which are shown in the column of " ⚠ WARNING" means that an improper handling could lead to a grave result like a death, serious injury, etc. However, even if precautions are shown in the column of " ⚠ CAUTION", a very serious problem could occur depending on situation. Make sure to observe these safety precautions faithfully because they are very important information to ensure the safety.
- Symbols which appear frequently in the text have following meanings.



	Strictly prohibited.		Observe instructions faithfully.		Provide a positive grounding.
---	----------------------	---	----------------------------------	---	-------------------------------

- When you have read through the manual, keep it always at hand for read consultation. If the operator is replaced, make sure to hand over this manual to the new operator.

CAUTIONS FOR INSTALLATION

















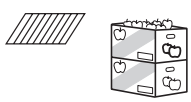



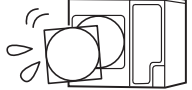

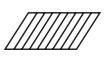







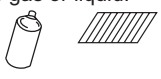

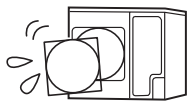

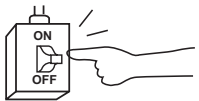

⚠ WARNING		
<p>The system should be applied to places as office, restaurant, residence and the like.</p> <p style="text-align: center;"></p> <p>Application to inferior environment such as an engineering shop, could cause equipment malfunction and serious injury or death.</p>	<p>The system should be installed by your dealer or a professional installer.</p> <p style="text-align: center;"></p> <p>Installation by yourself is not encouraged because it could cause such problems as water leakage, electrical shock or fire accident by some improper handling.</p>	<p>When you need some optional devices such as a humidifier, electric heater, etc., be sure to use the products which are recommended by us. These devices should be attached by a professional installer.</p> <p style="text-align: center;"></p> <p>Installation by yourself is not encouraged because it could cause such problems as water leakage, electrical shock or fire accident by some improper handling.</p>
⚠ CAUTION		
<p>Do not install nearby the place where may have leakage of flammable gas.</p> <p style="text-align: center;"></p> <p style="text-align: center;"></p> <p>If the gas leaks and gathers around, it may cause the fire.</p>	<p>Depending on the place of installation, a circuit breaker may be necessary.</p> <p style="text-align: center;"></p> <p>Unless the circuit breaker is installed, it could cause electrical shocks.</p> <p style="text-align: center;"></p>	<p>Drain pipe should be arranged to provide a positive draining.</p> <p style="text-align: center;"></p> <p>If the pipe is arranged improperly, furniture or the likes may be damaged by leaked water.</p> <p style="text-align: center;"></p>
<p>Where strong winds may prevail, the system should be fixed securely to prevent a collapse.</p> <p style="text-align: center;"></p> <p>Bodily injury could result by a collapse.</p>	<p>Install on the place where can endure the weight of air conditioner.</p> <p style="text-align: center;"></p> <p>Bodily injury could result by a careless installation.</p>	<p>Make sure the system is grounded.</p> <p style="text-align: center;"></p> <p style="text-align: center;"></p> <p>Grounding cable should never be connected to a gas pipe, city water pipe, lightning conductor rod or grounding cable of telephone. If the grounding cable is not set properly, it could cause electric shocks.</p>

CAUTIONS FOR TRANSFER OR REPAIR

⚠ WARNING	
<p>Modification of the system is strictly prohibited. When the system needs a repair, consult your dealer.</p> <p style="text-align: center;"></p> <p>Improper practice of repair could cause water leakage, electric shock or fire.</p>	<p>When the air conditioner is relocated, contact your dealer or a professional installer.</p> <p style="text-align: center;"></p> <p>Improper practice of installation could cause water leakage, electric shock or fire.</p>

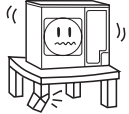
Safety Precautions

CAUTIONS FOR OPERATION

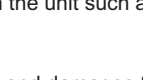
⚠ WARNING		
<p>You should refrain from exposing your body directly to cool wind for a long time.</p> <p> </p> <p>It could affect your physical condition or cause some health problems.</p>	<p>Do not poke the air inlet or outlet with a bar, etc.</p> <p> </p> <p>Since the internal fan is operating with a high speed, it could cause an injury.</p>	<p>When any abnormal condition (scorching smell or others) is found, stop the operation immediately and turn off the power switch. Then consult your dealer.</p> <p> </p> <p>If you continue the operation without removing the cause, it could result in a trouble, electric shock or fire.</p>
⚠ CAUTION		
<p>The system should never be used for any other purposes than intended such as for preservation of food, flora and fauna, precision devices or work of art.</p> <p> </p> <p>It could cause deterioration of food or other problems.</p>	<p>Do not handle switches with a wet hand.</p> <p> </p> <p>It could cause electric shocks.</p>	<p>Combustion apparatus should not be placed allowing a direct exposure to wind of air conditioner.</p> <p> </p> <p>Incomplete combustion could occur on the apparatus.</p>
<p>Do not wash the air conditioner with water.</p> <p> </p> <p>It could cause electric shocks.</p>	<p>Do not install the system where the air outlet reaches directly the flora and fauna.</p> <p> </p> <p>It will not be good for their health.</p>	<p>Make sure to use a fuse of proper electric rating.</p> <p> </p> <p>Use of steel or copper wire in place of a fuse is strictly prohibited because it could result in a trouble or fire accident.</p>
<p>Neither stand on the air conditioner nor place something on it.</p> <p> </p> <p>There are risks of falling or injury by collapsed object.</p>	<p>It is strictly prohibited to place a container of combustible gas or liquid near the air conditioner or to spray it directly with the gas or liquid.</p> <p> </p> <p>It could cause a fire accident.</p>	<p>Do not operate the system while the air outlet grill is removed.</p> <p> </p> <p>There is a risk of injury.</p>
<p>Do not use the power switch to turn on or off the system.</p> <p> </p> <p>It could cause a fire or water leakage.</p>	<p>Do not touch the air outlet section while the swing louver is operating.</p> <p> </p> <p>There is a risk of injury.</p>	<p>Do not use such equipment as a water heater, etc. around the indoor unit or the wire controller.</p> <p> </p> <p>If the system is operated at the vicinity of such equipment which generates steam, condensed water may drip during cooling operation or it could cause a fault current or short-circuit.</p>
<p>When operating the system simultaneously with a combustion apparatus, indoor air must be ventilated frequently.</p> <p> </p> <p>Insufficient ventilation could cause an oxygen deficiency accident.</p>	<p>Check occasionally the support structure of the unit for any damage after a use of long period of time.</p> <p> </p> <p>If the structure is not repaired immediately, the unit could topple down to cause a personal injury.</p>	<p>When cleaning the system, stop the operation and turn off the power switch.</p> <p> </p> <p>Cleaning should never be done while the internal fans are running with high speed.</p>
<p>Do not put water containers on the unit such as a flower vase, etc.</p> <p> </p> <p>If the water enters into the unit and damages the electric insulation material, it may cause electric shock.</p>		

Safety Precautions

The machine is adaptive in following situation

1. Applicable ambient temperature range:

Cooling	Indoor temperature	max. DB/WB min. DB/WB	32/23°C 18/14°C
	Outdoor temperature	max. DB/WB min. DB/WB	46/26°C 10/6°C
Heating	Indoor temperature	max. DB/WB min. DB/WB	27°C 15°C
	Outdoor temperature	max. DB/WB min. DB/WB	24/18°C -15°C

- If the supply cord is damaged, it must be replaced by the manufacturer or its service agent or a similar qualified person.
- If the fuse on the indoor PC board is broken please change it with the type of T 3.15A/250V(For AD125,AD140S2SM3FA,AD125,AD140S2SM4FA),or the type T 5A/250V(For AD90,AD105S2SM3FA,AD90,AD105S2SM4FA)
- The wiring method should be in line with the local wiring standard.
- The power cable should be:
H05RN-F 3G 4.0mm²(outdoor unit 1UH071/090/105N1ERG),or H05RN-F 3G 6.0mm²(outdoor unit 1UH125/140P1ERG), or H05RN-F 5G 4.0mm²(outdoor unit 1UH125/140P1EK),
The connecting cable should be:
H05RN-F 4G 2.5mm²
All the cables shall have got the European authentication certificate. During installation, when the connecting cables break off, it must be assured that the grounding wire is the last one to be broken off.
- The power cable and connect cable should be self-provided.
- The breaker of the air conditioner should be all-pole switch, and the distance between its two contacts should be no less than 3mm.
- The indoor unit installation height is at least 2.5m.
- A leakage breaker must be installed.
- For AD90S2SM3FA/AD90S2SM4FA/AD105S2SM3FA/AD105S2SM4FA/AD125S2SM3FA/AD125S2SM4FA/AD140S2SM3FA/AD140S2SM4FA,we can get the 10 different ESP through adjust wired controllerYR-E17,please refer below:

Stactic pressure grade	1	2	3	4	5	6	7	8	9	10
Stactic pressure	25Pa	37Pa	50Pa	70Pa	90Pa	100Pa	110Pa	120Pa	130Pa	150Pa

Adjsutment methcod by wired controller YR-E17: In the state of ON and non screen saving state, press Fan+ Set keys for 5 seconds to enter static pressure grade adjustment state with static pressure icon flashing and current static pressure grade statically displaying. Press key ↑ ↓ to change static pressure grade, then press Set key to confirm.

Details please refer to wired controller operation & installation manual.

Adjsutment methcod by Infrared remote controller+Infrared receiver RE-02: **Step a**:set the Infrared remote controller at condition: FAN mode , fan speed high **Step b**:then aim the remote controller at the infrared remote receiver RE-02, press HEALTH button 4+N times (1≤N≤10, integer) within 12 seconds , then the receiver will beep N+1 times , the static pressure level N is been set successfully.

Note: For Infrared remote controller YR-HBS01, need press ON/OFF button make the controller's at OFF status first, then open the button cover press FRESH button will enter FAN mode interface.

Parts and Functions

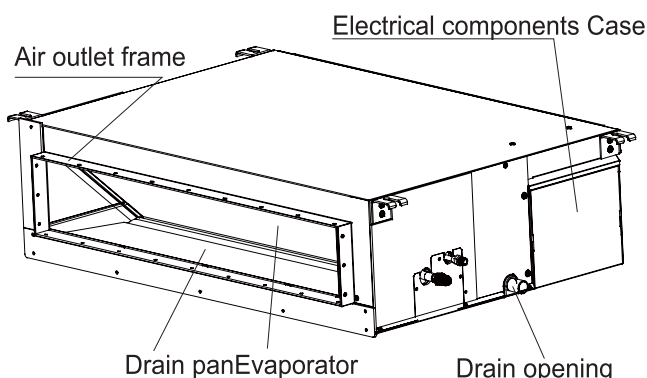

- AD90S2SM3FA AD90S2SM4FA
- AD105S2SM3FA AD105S2SM4FA
- AD125S2SM3FA AD125S2SM4FA
- AD140S2SM3FA AD140S2SM4FA

Installation Manual For Wire Controller

5. Wiring connections of wire controller:

There are three methods to connection wire controller and the indoor units:

A. One wired controller can control max. up to 16 sets of indoor units, and 3 pieces of polar wire must connect the wire controller and the master unit (the indoor unit connected with wire controller directly), the others connect with the master unit through 2 pieces of polar wire

B. One wire controller controls one indoor unit, and the indoor unit connects with the wire controller through 3 pieces of polar wire.

C. Two wired controllers control one indoor unit. The wire controller connected with indoor unit is called master one, the other is called slave one. Master wire controller and indoor unit; master and slave wire controllers are all connected through 3 pieces of polar wire.

6. Communication wiring:

The wire controller is equipped with special communication wiring in the accessories. 3-core terminal (1-white 2-yellow 3-red) is connected with the terminal A, B, C of wire controller respectively.

The communication wiring is 5 meter long; if the actual length is more than it, please distribute wiring according to below table:

Communication wiring length(m)	Dimensions of wiring
< 100	0.3mm ² x3-core shielded wire
≥ 100 and <200	0.5mm ² x3-core shielded wire
≥ 200 and <300	0.75mm ² x3-core shielded wire
≥ 300 and <400	1.25mm ² x3-core shielded wire
≥ 400 and <600	2mm ² x3-core shielded wire

WIRED CONTROLLER& INDOOR PCB CONNECTION(one for one wiring type):

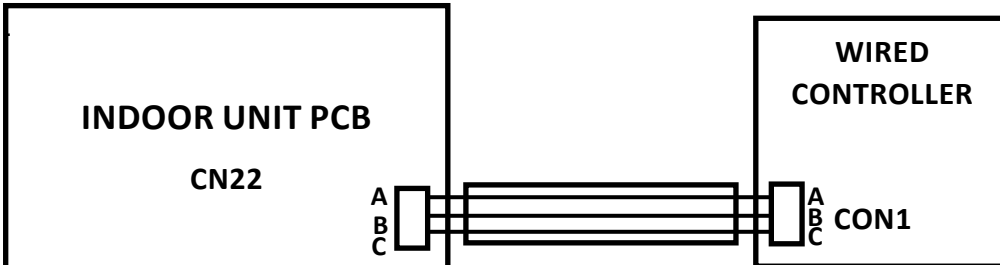

Note: When do the wired controller & indoor PCB wiring work for model AD50/71S2SM1FA, do not connect the shielded wired to the unit's shell, do not parallel wiring with strong electric lines within 0.3 meters, please keep strong lines and the signal lines separately.

Heating Mode

"HOT KEEP" function

"HOT KEEP" is operated in the following cases.

- When heating is started:
In order to prevent blowing out of cool wind, the indoor unit fan stopped according to the room temperature which heating operation is started. Wait for approx. 2 to 3 minute, and the operation will be automatically changed to the ordinary heating mode.
- Defrosting operation (in the heating mode):
When it is liable to frost, the heating operation is stopped automatically for 5 to 12 minutes once per approx. one hour, and defrosting is operated. After defrosting is completed, operation mode is automatically changed to ordinary heating operation.
- When the room thermostat is actuated:
When room temperature increases and room temperature controller actuates, the fan speed is automatically changed to stop under low temperature condition of indoor heat exchanger. When room temperature decreases, air conditioner automatically changes over to ordinary heating operation.



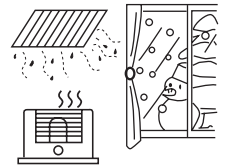

Warming operation

- Heat pump type warming
With the heat pump type warming, the mechanism of heat pump that concentrate heat of outdoor air with the help of refrigerant to warm the indoor space, is utilized.
- Defrosting operation
When a room is warmed with a heat pump type air conditioner, frost accumulates on the heat exchanger of outdoor unit along with the drop of indoor temperature. Since the accumulated frost reduces the effect of warming, it is necessary to automatically switch the operation to the defrosting mode. During the defrosting operation, heating operation is interrupted.
- Atmospheric temperature and warming capacity
Warming capacity of heat pump type air conditioner decreases along with the drop of outdoor temperature. When the warming capacity is not sufficient, it is recommended to use another heating implement.
- Period of warm-up
Since the heat pump type air conditioner employs a method to circulate warm winds to warm the entire space of a room, it takes time before the room temperature rises. It is recommendable to start the operation a little earlier in a very cold morning.



Care and Maintenance

Points to observe		
Turn off the power supply switch. 	Do not touch with wet hand. 	Do not use hot water or volatile liquid. 

CAUTION

- Do not open the inlet grill until fan stops completely.
- Fan will continue rotating for a while by the law of inertia after operation is being stopped.

Cleaning the air filter

1. Clean the air filter by lightly tapping it or with the cleaner. It is more effective to clean the air filter with water.

If the air filter is very dirty, dissolve neutral detergent in the lukewarm water (approx. 30°C), rinse the air filter in the water, and thoroughly wash the air filter off the detergent in the plain water.

2. After drying the air filter, set it up on the air conditioner.

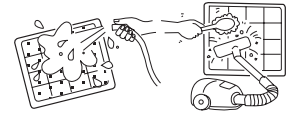

CAUTION

- Do not dry the air filter with fire.
- Do not run the air conditioner without the air filter.

Care and Cleaning of the unit

- Clean with soft and dry cloth.
- If it is very dirty, dissolve neutral detergent in the lukewarm water and make the cloth wet with the water. After wiping, clean off the detergent using clean water.

Post-Season Care



- Operate the unit with FAN mode on a fair day for about half a day to dry the inside of the unit well.
- Stop operation and turn off the power supply switch. Electric power is consumed even the air conditioner is in stop.
- Clean the air filter and set it in the place.

Pre-Season Care

- See that there are no obstacles blocking the air inlet and air outlet of both indoor and outdoor units.
- Make sure that the air filter is not dirty.
- Cut in the power supply switch 12 hours before starting run.

Troubleshooting

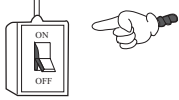
Please check the following things about your air conditioner before making a service call.

Unit fails to start			
<p>Is the power source switch adjust cut in?</p>  <p>Power supply switch is not ON.</p>	<p>Is city supply power in normal?</p> 	<p>Isn't the signal receiving section exposed to the direct sunlight or strong illumination?</p>	<p>Isn't the earth leakage breaker in action?</p> <p>It is dangerous. Turn off the power supply switch immediately and contact the sales dealer.</p>

Cooling or heating is not sufficient			
<p>Is the thermostat adjust as required?</p>	<p>Isn't the air filter dirty?</p>	<p>Isn't any doors or windows left open?</p>	<p>Doesn't any obstacle exist at the air inlet or outlet?</p>
<p>Isn't the swing louver horizontal? (At HEATING mode) If swing louver is horizontal, the blow wind does not reach floor.</p>			



Cooling is not sufficient			
<p>Isn't sun-shine invading direct?</p>	<p>Isn't any unexpected heating load generated?</p>	<p>Isn't the room much crowded?</p>	<p>The wind does not blow during heating operation</p> <p>Isn't it warming up?</p>

When the air conditioner does not operate properly after you have checked the above mentioned items or when the following phenomenon is observed, stop the operation of the air conditioner and contact your sales dealer.

- The fuse or breaker often shuts down.
- Water drops off during cooling operation.
- There is a irregularity in operation or abnormal sound is audible.
- When the CHECK LED (red) flickers, an irregularity has occurred in the air conditioner.

Troubleshooting

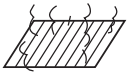
The followings are not malfunction

<p>Water flowing sound is heard.</p> 	<p>When the air conditioner is started, when the compressor starts or stops during operation or when the air conditioner is stopped, it sometimes sounds "shuru shuru" or "gobo gobo". It is the flowing sound of the refrigerant, and it is not a trouble.</p>
<p>Cracking sound is heard.</p>	<p>This is caused by heat expansion or contraction of plastics.</p>
<p>It smells.</p>	<p>Air which blows out from the indoor unit sometimes smells. The smell results from residents of tobacco smoke or cosmetics stuck inside of unit.</p>
<p>During operation, white fog comes out of indoor unit.</p> 	<p>When the air conditioner is used at restaurant etc. where dense edible oil fume is always exists, white fog sometimes blows out of air outlet during operation. In this case consult sales dealer for cleaning the heat exchanger.</p>
<p>It is switched into the FAN mode during cooling.</p>	<p>To prevent frost from being accumulated on the indoor unit heat exchanger, it is sometimes automatically switched to the FAN mode, but it will soon return to the cooling mode.</p>
<p>The air conditioner can not be restarted soon after it stops.</p> 	<p>Even if the operation switch is turned on, cooling, dehumidifying or heating is not operable for three minutes after the conditioner is stopped. Because the protecting circuit is activated. (During this time air conditioner operates in fan mode.)</p> 
<p>Air does not blow or the fan speed can not be changed during dehumidifying.</p>	<p>When it is excessively cooled during dehumidifying, the blower automatically repeats reducing and lowering the fan speed.</p>
<p>During operation, operation mode has changed over automatically.</p>	<p>Isn't the AUTO mode selected? In the case of AUTO mode, operation mode is changed automatically from cooling to heating or vice-versa according to the room temperature.</p>
<p>Water or steam generates from the outdoor unit during heating.</p>	<p>This results when frost accumulated on the outdoor unit is removed (during defrosting operation).</p>

Troubleshooting

INDOOR UNIT TROUBLE SHOOTING

AD90/105S2SM3FA,AD90/105S2SM4FA

LED flash times of indoor PCB		Wired controller display	Contents of Malfunction	Possible reasons
LED4	LED3			
0	1	01	Malfunction of indoor unit ambient temperature sensor	Sensor disconnected,or broken,or at wrong position,or short circuit
0	2	02	Malfunction of indoor unit piping temperature sensor	Sensor disconnected,or broken,or at wrong position,or short circuit
0	4	04	EEPROM wrong of indoor PCB	EEPROM chip disconnected or broken or wrong programmed,or PCB broken
0	7	07	Abnormal communication between indoor and outdoor units	Wrong connection,or the wires be disconnected or wrong address setting of indoor unit or faulty power supply or faulty PCB or slave unit malfunction in MAXI system
0	8	07 *flashing	Abnormal communication between wired controller and indoor unit	Wrong connection or wired controller broken,or PCB faulty
0	12	0C	Malfunction of drain system	Pump motor disconnected or at wrong position,or the float switch,disconnected, or at wrong position,or the short circuit bridge disconnected
0	13	0D	Zero cross signal wrong	Zero cross signal detected wrong
0	14	0E	Indoor unit DC fan motor abnormal	DC Fan motor disconnected or DC Fan broken or circuit broken or motor blocked

Note:

- The outdoor failure can also be indicated by the indoor unit,the checking method as follows: If the outdoor error code is M (DECIMAL), the indoor unit's wired controller display will show the after converted hexadecimal code of "M+20"(DECIMAL), for example,if the outdoor error code is 2,the indoor unit wired controller display will flash the error code 16 (2→2+20=22 →change decimal 22 to hexadecimal code,get 16)
- To get much more details about the outdoor unit failure,please refer to the outdoor unit trouble shooting list.
- For YR-E17, communication error between I.D. PCB and wired controller, 07 will flash in the main display interface not the check display interface.

Troubleshooting

INDEER UNIT TROUBLE SHEETING

AD125/140S2SM3FA,AD125/140S2SM4FA

LED flash times of indoor PCB		Wired controller display	Contents of Malfunction	Possible reasons
LED4	LED3			
0	1	01	Malfunction of indoor unit ambient temperature sensor	Sensor disconnected, or broken, or at wrong position, or short circuit
0	2	02	Malfunction of indoor unit piping temperature sensor	Sensor disconnected, or broken, or at wrong position, or short circuit
0	4	04	EEPROM wrong of indoor PCB	EEPROM chip disconnected or broken or wrong programmed, or PCB broken
0	7	07	Abnormal communication between indoor and outdoor units	Wrong connection, or the wires be disconnected or wrong address setting of indoor unit or faulty power supply or PCB hardware malfunction
0	8	07* flashing	Abnormal communication between wired controller and indoor unit	Wrong connection or wired controller broken, or PCB hardware malfunction
0	12	0C	Malfunction of drain system	Pump motor disconnected or at wrong position, or the float switch disconnected, or at wrong position, or the short circuit bridge disconnected
0	13	0D	Zero cross signal wrong	Zero cross signal detected wrong
0	14	0E	Abnormal communication between main control PCB & fan motor driver	communication wire disconnected or wrong connected or PCB hardware malfunction
0	15	0F	Fan motor overcurrent	Fan motor current too high
0	17	11	DC voltage high or low	DC voltage of the fan motor driver too high or too low
0	18	12	F.M.D temperature high	Fan motor driver over 95°C
0	19	13	Fan motor out of step	Wrong rotor location detected
M(≥1)	N(≥0)	/	Error of the outdoor unit	See note 1,2

Note:

1. The outdoor failure can also be indicated by the indoor unit, the checking method as follows: outdoor unit error code=(M*10+N)-20. LED4 flash M times and LED3 flash N times .

2. To get much more details about the outdoor unit failure, please refer to the outdoor unit trouble shooting list.

Precaution for Installation

- Please read these "Safety Precautions" first and then accurately execute the installation work.
- Though the precautionary points indicated herein are divided under two headings, ⚠ WARNING and ⚠ CAUTION, those points which are related to the strong possibility of an installation done in error resulting in death or serious injury are listed in the ⚠ WARNING section. However, there is also a possibility of serious consequences in relationship to the points listed in the ⚠ CAUTION section as well. In either case, important safety related information is indicated, so by all means, properly observe all that is mentioned.
- After completing the installation, along with confirming that no abnormalities were seen from the operation tests, please explain operating methods as well as maintenance methods to the user (customer) of this equipment, based on the owner's manual. Moreover, ask the customer to keep this sheet together with the owner's manual.

⚠ WARNING





- This system should be applied to places as office, restaurant, residence and the like. Application to inferior environment such as engineering shop could cause equipment malfunction.
- Please entrust installation to either the company which sold you the equipment or to a professional contractor. Defects from improper installations can be the cause of water leakage, electric shocks and fires.
- Execute the installation accurately, based on following the installation manual. Again, improper installations can result in water leakage, electric shocks and fires.
- When a large air-conditioning system is installed to a small room, it is necessary to have a prior planned countermeasure for the rare case of a refrigerant leakage, to prevent the exceeding of threshold concentration. In regards to preparing this countermeasure, consult with the company from which you purchased the equipment, and make the installation accordingly. In the rare event that a refrigerant leakage and exceeding of threshold concentration does occur, there is the danger of a resultant oxygen deficiency accident.
- For installation, confirm that the installation site can sufficiently support heavy weight. When strength is insufficient, injury can result from a falling of the unit.
- Execute the prescribed installation construction to prepare for earthquakes and the strong winds of typhoons and hurricanes, etc. Improper installations can result in accidents due to a violent falling over of the unit.
- For electrical work, please see that a licensed electrician executes the work while following the safety standards related to electrical equipment, and local regulations as well as the installation instructions, and that only exclusive use circuits are used. Insufficient power source circuit capacity and defective installation execution can be the cause of electric shocks and fires.
- Accurately connect wiring using the proper cable, and insure that the external force of the cable is not conducted to the terminal connection part, through properly securing it. Improper connection or securing can result in heat generation or fire.
- Take care that wiring does not rise upward, and accurately install the lid/service panel. Its improper installation can also result in heat generation or fire.
- When setting up or moving the location of the air conditioner, do not mix air etc. or anything other than the designated refrigerant R32 within the refrigeration cycle. Rupture and injury caused by abnormal high pressure can result from such mixing.
- Always use accessory parts and authorized parts for installation construction. Using parts not authorized by this company can result in water leakage, electric shock, fire and refrigerant leakage.

⚠ CAUTION

- Execute proper grounding. Do not connect the ground wire to a gas pipe, water pipe, lightning rod or a telephone ground wire. Improper placement of ground wires can result in electric shock.
- The installation of an earth leakage breaker is necessary depending on the established location of the unit. Not installing an earth leakage breaker may result in electric shock.
- Do not install the unit where there is a concern about leakage of combustible gas. The rare event of leaked gas collecting around the unit could result in an outbreak of fire.
- For the drain pipe, follow the installation manual to insure that it allows proper drainage and thermally insulate it to prevent condensation. Inadequate plumbing can result in water leakage and water damage to interior items.

Is The Unit Installed Correctly

Confirm the following items for safe and comfortable use of air conditioner.
The installation work is to be burden on the sales dealer, and do not conduct it by yourself.

Installation place		
<p>Avoid installing the air conditioner near the place where possibility of inflammable gas leakage exists.</p>  <p>Explosion (Ignition) may occur.</p>	<p>Install the unit at well ventilated place.</p>  <p>If some obstacle exist, it may cause capacity reduction or noise increase.</p>	<p>Install the air conditioner firmly on the foundation that can fully support the weight of the unit.</p>  <p>If not, it may cause vibration or noise.</p>
<p>Select the place so as not to annoy neighbor with the hot air or noise.</p> 	<p>Snow protection work is necessary where outdoor unit is blocked up by snow. For details consult your sales dealer.</p>	<p>It is advisable not to install the air conditioner at the following special place. It may cause malfunction, consult the sales dealer when you have to install the unit on such a place.</p> <ul style="list-style-type: none"> • The place where corrosive gas generates (Hot spring area etc.) • The place where salt breeze blows (Seaside etc.) • The place where dense soot smoke exists • The place where humidity is extraordinarily high • The place where near the machine which radiates the electromagnetic wave • The place where voltage variation is considerably large

Electric work

The electric work must be burden on the authorized engineer with qualification for electric work and grounding work, and the work must be conducted in accordance with electric equipment technical standard.

- The power source for the unit is to be of exclusive use.
- An earth leakage breaker should be installed. (This is necessary to prevent electric shock.)
- The unit must be grounded.

When you change your address or the installation place

Special technology is required for removal or reinstallation of air conditioner, consult the sales dealer. Besides, construction expense is charged for removal or reinstallation.

For inspection and maintenance

The capacity of air conditioner will decrease by contamination of inside of unit when it is used for about three years although depending upon the circumstances under which it is used, and so in addition to the usual maintenance service, special inspection/maintenance service is necessary. It is recommended to make a maintenance contract (charged) by consulting your sales dealer.

NOTE

All wiring of this installation must comply with NATIONAL, STATE AND LOCAL REGULATIONS. These instructions do not cover all variations for every kind of installation circumstance. Should further information be desired or should particular problems occur, the matter should be referred to your local distributor.

WARNING

BE SURE TO READ THESE INSTRUCTIONS CAREFULLY BEFORE BEGINNING INSTALLATION. FAILURE TO FOLLOW THESE INSTRUCTIONS COULD CAUSE SERIOUS INJURY OR DEATH, EQUIPMENT MALFUNCTION AND/OR PROPERTY DAMAGE.

Preparation of indoor unit

Before or during the installation of the unit, assemble necessary optional panel etc. depending on the specific type.

Select places for installation satisfying following conditions and at the same time obtain the consent on the part of your client user.

- Places where chilled or heated air circulates freely. When the installation height exceeds 3m warmed air stays close to the ceiling. In such cases, suggest your client users to install air circulators.
- Places where perfect drainage can be prepared and sufficient drainage.
- Places free from air disturbances to the suction port and blowout hole of the indoor unit, places where the fire alarm may not malfunction or short-circuit.
- Places with the environmental dew-point temperature is lower than 28°C and the relative humidity is less than 80 %. (When installing at a place under a high humidity environment, pay sufficient attention to the prevention of dewing such as thermal insulation of the unit.)
- Ceiling height shall have the following height.

	AD90S2SM3FA AD90S2SM4FA AD105S2SM3FA AD105S2SM4FA AD125S2SM3FA AD125S2SM4FA AD140S2SM3FA AD140S2SM4FA
Combination with silent panel	366mm

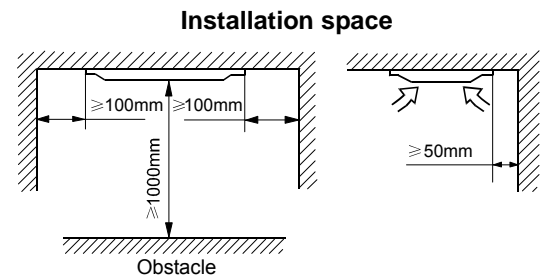

Avoid installation and use at those places listed below.

- Places exposed to oil splashes or steam (e.g. kitchens and machine plants).
Installation and use at such places incur deteriorations in the performance or corrosion with the heat exchanger or damage in molded synthetic resin parts.
- Places where corrosive gas (such as sulfurous acid gas) or inflammable gas (thinner, gasoline etc.) in generated or remains. Installation and use at such places cause corrosion in the heat exchanger and damage in molded synthetic resin parts.
- Places adjacent to equipment generating electromagnetic waves or high-frequency waves such as in hospitals.
Generated noise may cause malfunctioning of the controller.

Pipe size

Model	Liquid side	Gas side
AD90S2SM3FA AD90S2SM4FA AD105S2SM3FA AD105S2SM4FA AD125S2SM3FA AD125S2SM4FA AD140S2SM3FA AD140S2SM4FA	∅ 9.52mm	∅ 15.88mm

1. Preparation for suspending the unit

a. Size of hole at ceiling and position of hanging bolts

<Combination with silent panel>

AD90S2SM3FA AD90S2SM4FA AD105S2SM3FA AD105S2SM4FA
AD125S2SM3FA AD125S2SM4FA AD140S2SM3FA AD140S2SM4FA

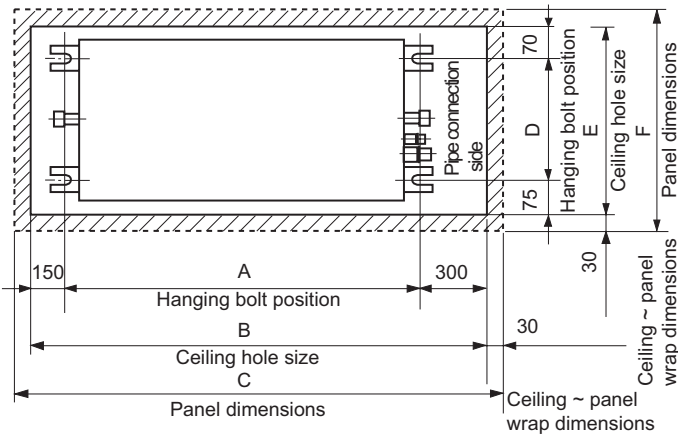

Model	Dimensions					
	A(mm)	B(mm)	C(mm)	D(mm)	E(mm)	F(mm)
AD90S2SM3FA AD90S2SM4FA	1162	1612	1672	620	765	825
AD105S2SM3FA AD105S2SM4FA AD125S2SM3FA AD125S2SM4FA AD140S2SM3FA AD140S2SM4FA	1562	2012	2072	620	765	825

b. Hanger bolts installation

Use care of the piping direction when the unit is installed.

2. Installation of indoor unit

Fix the indoor unit to the hanger bolts.

If required, it is possible to suspend the unit to the beam, etc. Directly by use of the bolts without using the hanger bolts.

Note

When the dimensions of main unit and ceiling holes does not match, it can be adjusted with the slot holes of hanging bracket.

Adjusting to the levelness

- Adjust the out-of levelness using a level or by the following method. Make adjustment so that the relation between the lower surface of the unit proper and water level in the hose becomes as given below.
- Unless the adjustment to the levelness is made properly, malfunctioning or failure of the float switch may occur.

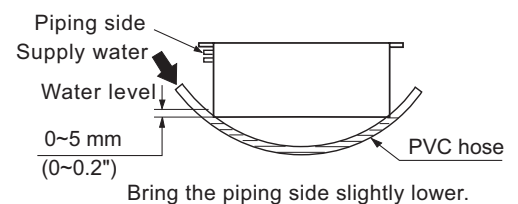
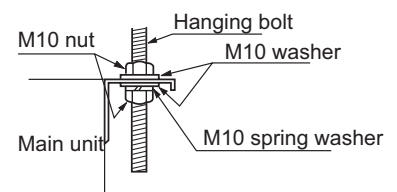
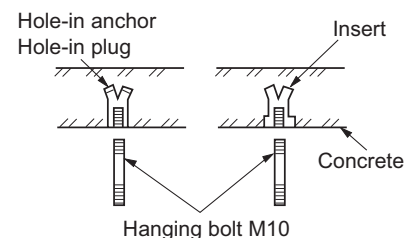

Tap selection on blower unit

(When the high performance filter is used.)

Taps of blower unit are set at the standard selection at the shipping from factory. Where the static pressure is raised by employing such option as the high performance filter, etc., change the connection of connectors provided at the flank of control box as shown below.

Standard tap (at shipping)				High speed tap			
Control box side	White	Connector white	White	Motor side	White	Red	Black
	Blue		Blue		White		
	Yellow		Yellow		Blue		
	Red		Red		Red		

Drain Piping

(a) Drain piping should always be in a downhill grade (1/50~1/100) and avoid riding across an elevation or making traps.

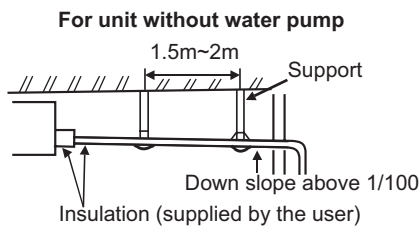
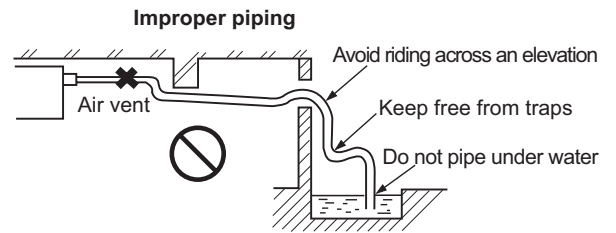
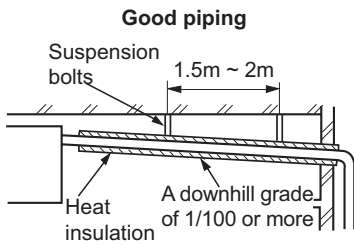

Unit model	The size of drain opening
AD90S2SM3FA AD90S2SM4FA	ø 25mm
AD105S2SM3FA AD105S2SM4FA	
AD125S2SM3FA AD125S2SM4FA	
AD140S2SM3FA AD140S2SM4FA	

(b) When connecting the drain pipe to unit, pay sufficient attention not to apply excess force to the piping on the unit side. Also, fix the piping at a point as close as possible to the unit.

(c) For unit without water pump, please refer to the diagram and select drain pipe size according to drain opening inner diameter size. The drain pipe shall be slant downwards (greater than 1/100). The horizontal length of the drain pipe shall be less than 20 m. In case of long pipe, supports shall be provided every 1.5~2m to prevent wavy form. Central piping shall be laid out according to the right figure. Take care not to apply external force onto the drain pipe connection part.

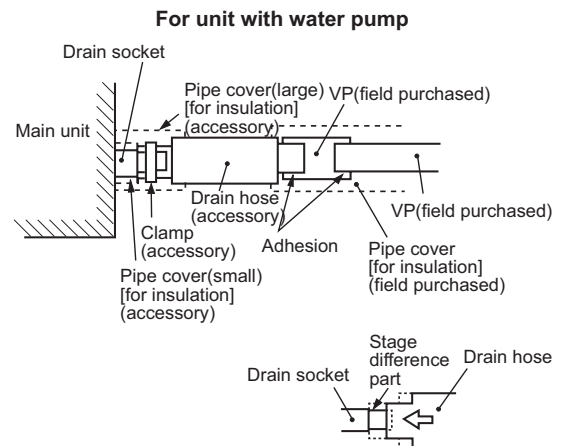

(d) For unit with water pump drain pipe use hard PVC general purpose pipe VP which can be purchased locally. When connecting, insert a PVC pipe end securely into the drain socket before tightening securely using the attached drain hose and clamp. Adhesive must not be used for connection of the drain socket and drain hose (accessory).

(e) When constructing drain piping for several units, position the common pipe about 100 mm below the drain outlet of each unit as shown in the sketch. Use VP-30(1 1/4") or thicker pipe for this purpose.

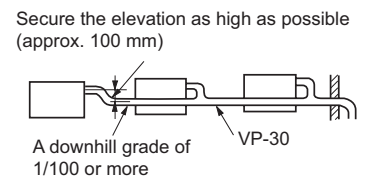

(f) The hard PVC pipe put indoor side should be heat insulated. Do not ever provide an air vent.

(g) The height of the drain head can be elevated up to a point 500 mm above the ceiling, and when an obstacle exists in the ceiling space, elevate the piping to avoid the obstacle using an elbow or corresponding gadget. When doing this, if the stretch for the needed height is higher than 500 mm, the back-flow quantity of drain at the event of interruption of the operation gets too much and it may cause overflow at the drain pan. Therefore, make the height of the drain pipe within the distance given in the sketch below.

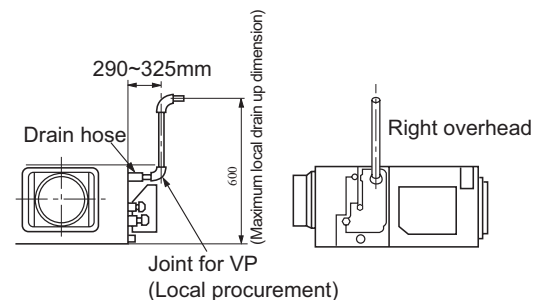

(h) Avoid positioning the drain piping outlet at a place where generation of odor may be stimulated. Do not lead the drain piping direct into a sewer from where sulfur gas may generate.

Installation Procedure

Drainage Test

- (1) Conduct a drainage test after completion of the electrical work.
- (2) During the trial, make sure that drain flows properly through the piping and that no water leaks from connections.
- (3) In case of a new building, conduct the test before it is furnished with the ceiling.
- (4) Be sure to conduct this test even when the unit is installed in the heating season.

Procedures

- (a) Supply about 1000 cc of water to the unit through the air outlet using a feed water pump.
- (b) Check the drain while cooling operation.

Before the electrical work has not been completed, connect a convex joint in the drain pipe connection to provide a water inlet. Then, check if water leaks from the piping system and that drain flows through the drain pipe normally.

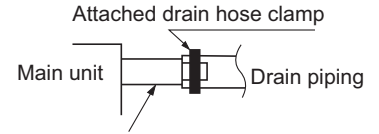
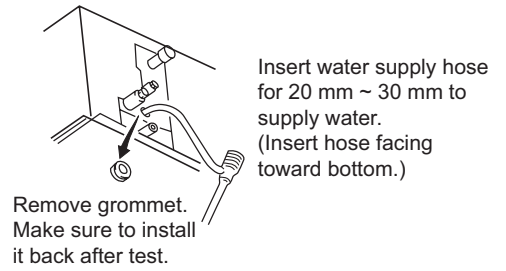

Drain situation can be checked with transparent socket

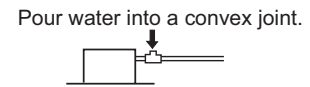

Installation Procedure

Installation work for air outlet ducts

Calculate the draft and external static pressure and select the length, shape and blowout.

(A) Blowout duct

- 2-spot, 3-spot and 4-spot with ϕ 200 type duct are the standard specifications.

Note (1) Shield the central blowout hole for 2-spot.

(2) Shield the blowout hole around the center for 3-spot.

- Limit the difference in length between spots at less than 2:1.
- Reduce the length of duct as much as possible.
- Reduce the number of bends as much as possible. (Corner R should be as larger as possible.)
- Use a band, etc. to connect the main unit and the blowout duct flange.
- Conduct the duct installation work before finishing the ceiling.

Connection of suction, exhaust ducts

a. Fresh air inlet

- Inlet can be selected from the side or rear faces depending on the working conditions.
- Use the rear fresh air inlet when the simultaneous intake and exhaust is conducted. (Side inlet cannot be used.)

b. Exhaust (Make sure to use also the suction.)

Use the side exhaust port.

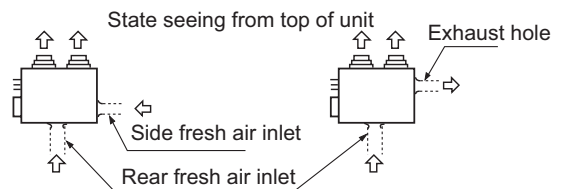
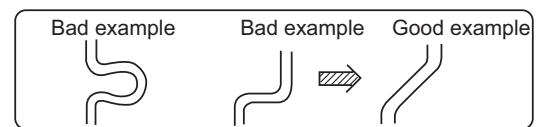
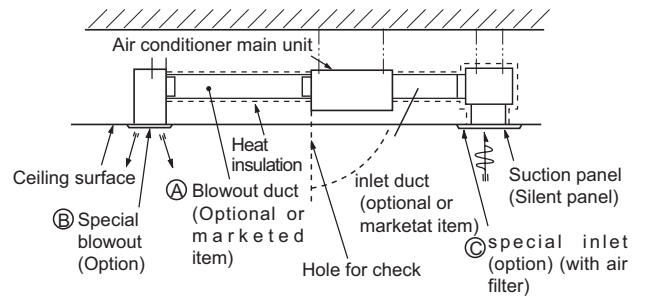

Fig.1

Fig.2

⚠ WARNING

DANGER OF BODILY INJURY OR DEATH

- TURN OFF ELECTRIC POWER AT CIRCUIT BREAKER OR POWER SOURCE BEFORE MAKING ANY ELECTRIC CONNECTIONS.
- GROUND CONNECTIONS MUST BE COMPLETED BEFORE MAKING LINE VOLTAGE CONNECTIONS.

Precautions for electrical wiring

- Electrical wiring work should be conducted only by authorized personnel.
- Do not connect more than three wires to the terminal block. Always use round type crimped terminal lugs with insulated grip on the ends of the wires.
- Use copper conductor only.

Selection of size of power supply and interconnecting wires

Select wire sizes and circuit protection from table below. (This table shows 20 m length wires with less than 2% voltage drop.)

Item Model	Phase	Circuit breaker		Power source wire size (minimum) (mm ²)	Earth leakage breaker	
		Switch breaker (A)	Overcurrent protector rated capacity (A)		Switch breaker(A)	Leak current(mA)
AD90S2SM3FA AD90S2SM4FA AD105S2SM3FA AD105S2SM4FA AD125S2SM3FA AD125S2SM4FA AD140S2SM3FA AD140S2SM4FA	1	40	30	6.0	40	30

POWER SUPPLY & INDOOR-OUTDOOR CONNECTION:

Make wiring to supply power to the outdoor unit, so that the power for the indoor unit is supplied by outdoor unit terminal blocks.

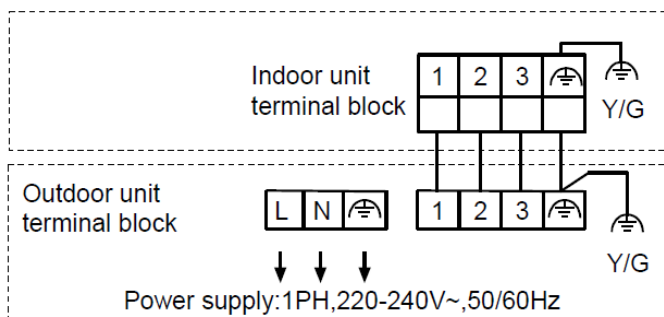

Move and scrap the air conditioning

- When moving, to disassemble and re-install the air conditioning, please contact your dealer for technical support.
- In the composition material of air conditioning, the content of lead, mercury, hexavalent chromium, polybrominated biphenyls and polybrominated diphenyl ethers are not more than 0.1% (mass fraction) and cadmium is not more than 0.01% (mass fraction).
- Please recycle the refrigerant before scrapping, moving, setting and repairing the air conditioning; for the air conditioning scrapping, should be dealt with by the qualified enterprises.



Haier

Address: Haier Industrial Park, Qianwangang Road, Eco-Tech Development Zone, Qingdao 266555, Shandong, P.R.C.

Contacts: TEL +86-532-88936943; FAX +86-532-8893-6999

Website: www.haier.com