

SPLIT TYPE ROOM AIR CONDITIONER OPERATION MANUAL

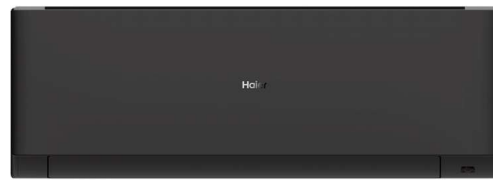

AS20XCAHRA
AS25XCAHRA
AS35XCAHRA
AS42XCAHRA
AS50XCAHRA
AS71XCAHRA

AS20XCAHRA-MB
AS25XCAHRA-MB
AS35XCAHRA-MB
AS42XCAHRA-MB
AS50XCAHRA-MB
AS71XCAHRA-MB

- Please read this operation manual before using the air conditioner. Keep this operation manual for future reference. This appliance is filled with R32.



English

Español

Italiano

Français

Deutsch

Português

POLSKI

TÜRKÇE

ΕΛΛΗΝΙΚΑ

HRVATSKI

Български

Češky

Nederlands



Read the precautions in this manual carefully before operating the unit.



This appliance is filled with R32.

Keep this manual where the user can easily find it.

WARNING:

English

- Do not use means to accelerate the defrosting process or to clean, other than those recommended by the manufacturer.
- The appliance must be stored in a room without continuously operating ignition sources (for example: open flames, an operating gas appliance or an operating electric heater).
- Do not pierce or burn.
- Be aware that refrigerants may not contain an odour.
- The appliance must be installed, operated and stored in a room with a floor area larger than 3 m².
- If the supply cord is damaged, it must be replaced by the manufacturer, its service agent or similarly qualified persons in order to avoid a hazard.
- This appliance can be used by children aged 8 years and above and persons with reduced physical, sensory or mental capabilities or lack of experience and knowledge if they have been given supervision or instruction concerning use of the appliance in a safe way and understand the hazards involved. Children shall not play with the appliance. Cleaning and user maintenance shall not be made by children without supervision.
- The wiring method should be in line with the local wiring standard.
- All the cables shall have got the European authentication certificate. During installation, when the connecting cables break off, it must be assured that the grounding wire is the last one to be broken off. The explosion-proof breaker of the air conditioner should be all-pole switch. Distance between its two contacts should not be no less than 3mm. Such means for disconnection must be incorporated in the wiring.
- Make sure installation is done according to local wiring regulation by professional persons.
- Make sure ground connection is correct and reliable.
- A leakage explosion-proof breaker must be installed.
- Do not use a refrigerant other than the one indicated on the outdoor unit (R32) when installing, moving or repairing. Using other refrigerants may cause trouble or damage to the unit, and personal injury.



This appliance contains a UV-C lamp.

WARNING:

- Read the maintenance instructions before opening the appliance.
- Eye or skin irritation may result from exposure from top air inlet and inner part. During air filter taking and putting for maintenance, please make sure that the power is cut off before approaching the product.
- UV-C barriers bearing the ultraviolet radiation hazard symbol should not be removed.
- Appliances that are obviously damaged must not be operated.
- Do not operate UV-C lamps outside of the appliance.
- The appliance must be disconnected from the power supply before replacing or cleaning or other maintenance of the UV-C lamp.
- Front panels bearing the ultraviolet radiation hazard symbol which have UV-C radiation are provided with a hall switch to interrupt the power to the UV-C lamps for your safety. Do not over-ride hall switch by magnet and other similar material.
- Before opening front panels bearing the ultraviolet radiation hazard symbol for the conducting user maintenance, it is recommended to disconnect the power.
- If the UV-C lamp is damaged, it must be replaced by the manufacturer, its service agent or similarly qualified persons in order to avoid a hazard.
- Unintended use of the appliance or damage to the housing may result in the escape of dangerous UV-C radiation. UV-C radiation may, even in small doses, cause harm to the eyes and skin.

Contents

PARTS AND FUNCTIONS	1
OPERATION	2
INDOOR UNIT INSTALLATION	12
MAINTENANCE	15
CAUTIONS	17
TROUBLE SHOOTING	18

Parts and Functions

Indoor Unit

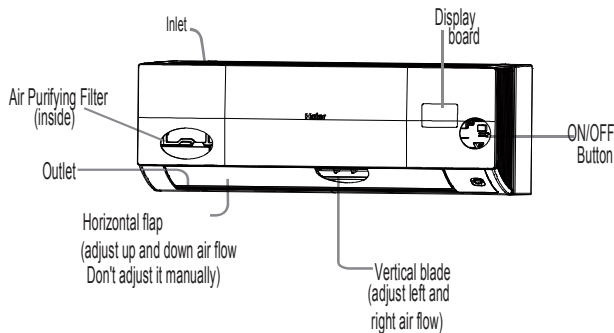

Display board

- ① Signal receiver
- ② Setting temp. display

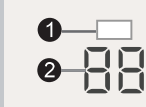

NOTE:

Actual inlet grille may vary from the one shown in the manual depending on the product purchased.

Outdoor Unit

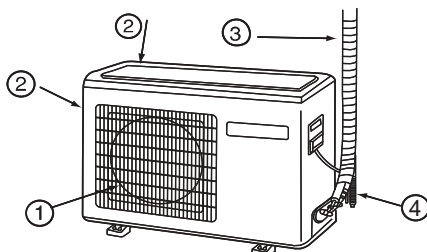

- ① OUTLET ③ CONNECTING PIPING AND ELECTRICAL WIRING
- ② INLET ④ DRAIN HOSE

Please note the above picture is for reference only.
This may vary depending on the unit purchased.

Remote controller

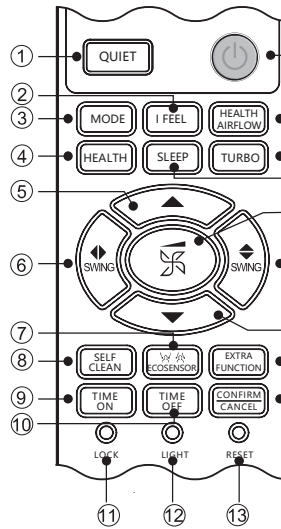

1. QUIET button
2. I FEEL button
3. MODE button
4. HEALTH button
5. TEMP+/- button
6. SWING left/right button
7. ECOSENSOR button
8. SELF CLEAN button
9. TIME ON button
10. TIME OFF button
11. LOCK button
12. LIGHT button
13. RESET button
14. CONFIRM/CANCEL button
15. EXTRA FUNCTION button
16. SWING up/down button
17. FAN button
18. SLEEP button
19. TURBO button
20. HEALTH AIRFLOW button
21. ON/OFF button

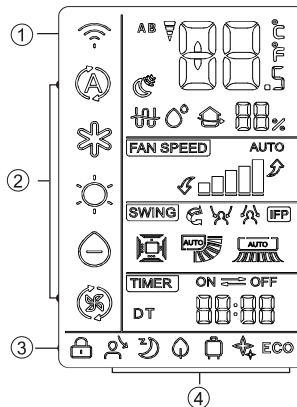

1. Wi-Fi display
2. Operation mode display
3. LOCK display
4. Display of each function status
5. TIMER ON display
TIMER OFF display
CLOCK display
6. SWING display
Swing up/down display
Swing left/right display
7. FAN SPEED display
8. Humidity display
9. TEMP display

NOTE:

1. Humidity display is unavailable on some models.
2. If the model you buy has a Wi-Fi function, press the "ON/OFF" button for 5s to emit the Wi-Fi binding signal. Once in the binding mode, the APP will show how to bind.

Operation

■ Clock set

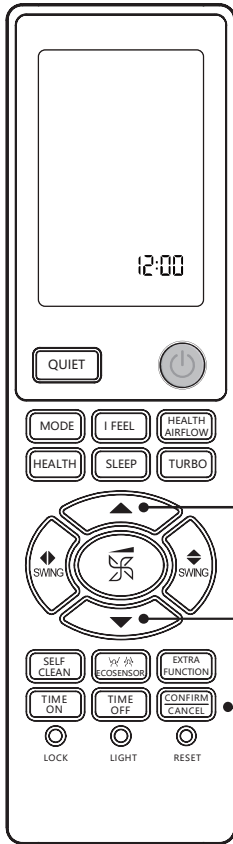

1. Load the battery or press the "RESET" button



2. Press "▲" or "▼" to set correct time

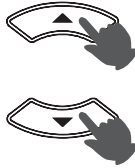

Each press will increase or decrease 1min. If the button is kept pressed, time will change quickly.

3. After time setting is confirmed, press "confirm" button, while clock starts working



Attention:

The distance between the signal transmission head and the receiver hole should be within 7m without any obstacle as well. When electronic-started type fluorescent lamp or change-over wireless telephone is installed in room, the receiver is apt to be disturbed in receiving the signals, so the distance to the indoor unit should be shorter. Full display or unclear display during operation indicates the batteries have been used up. Please change batteries. If the remote controller can't run normally during operation, please remove the batteries and reload several minutes later.

NOTE:

Remove the batteries in case unit won't be in usage for a long period.

■ LOCK/LIGHT/RESET/ EXTRA FUNCTION

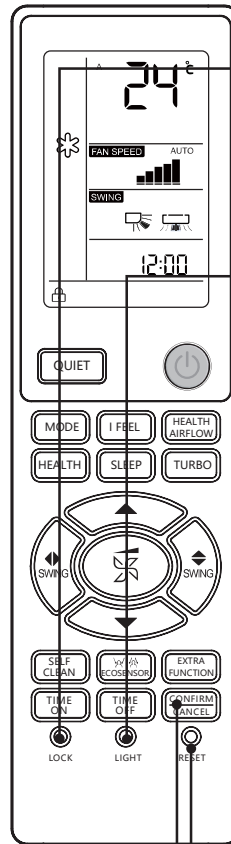

1. LOCK Button



Used to lock buttons and LCD display.

2. LIGHT Button



Turn on and off the indoor display. To display only set temperature, press LIGHT button 10 times within 5 seconds. The indoor unit will beep 3 times when successful. To return to ambient temperature display, press LIGHT 10 times within 5 seconds again. Default of the indoor unit display is ambient temperature. The set temperature will only display for a few seconds after adjusting it with the remote.

3. RESET Button



If the remote control is not functioning properly, press this button to reset the remote.

4. EXTRA FUNCTION Button



Function: A-B yard → 10°C heating (Only in heating mode) → °F/°C transform

Operation

AUTO, COOL, HEAT, DRY, FAN Operation

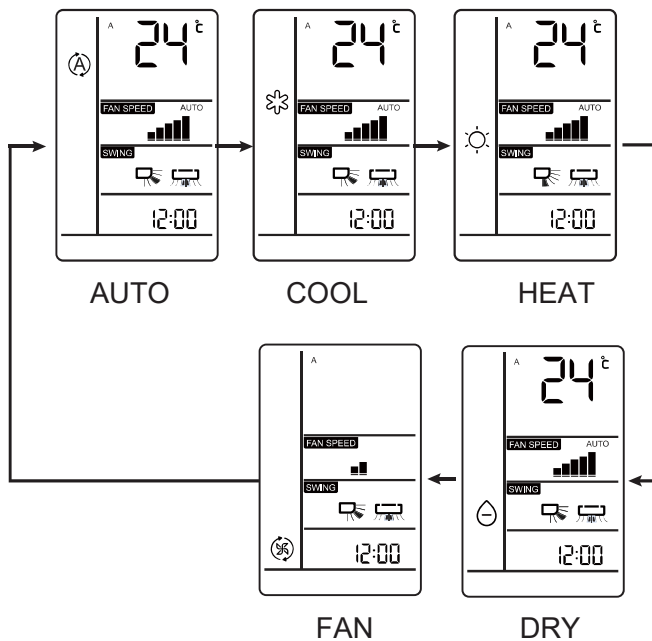
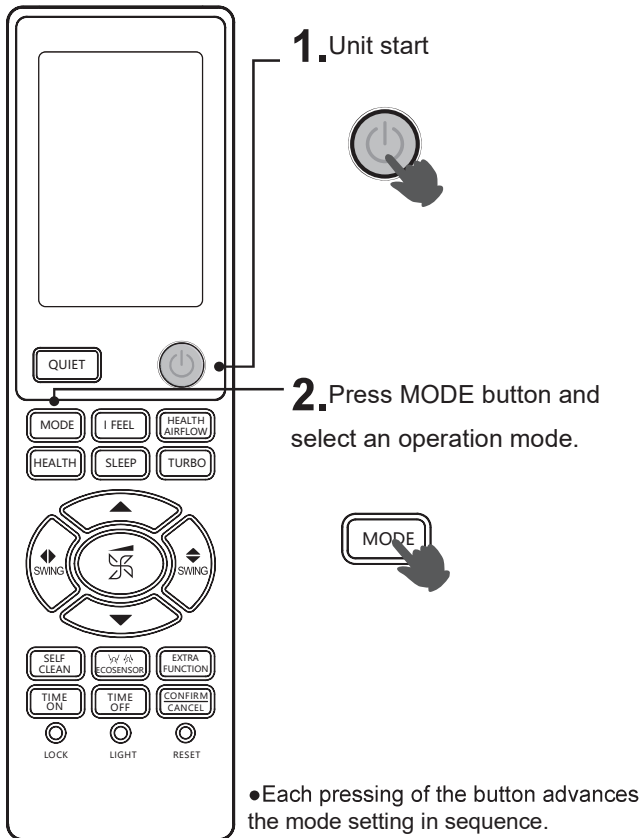

Mode	Note
AUTO	In AUTO mode, the air conditioner will automatically select Cool or Heat operation according to room temperature. When FAN is set to AUTO, the air conditioner automatically adjusts the fan speed according to room temperature.
COOL	Cooling only
DRY	In DRY mode, when room temperature becomes lower than temp.setting+2°C, the unit will run intermittently at LOW speed regardless of FAN setting.
HEAT	In HEAT mode, warm air will blow out after a short period of the time due to cold-draft prevention function. When FAN is set to AUTO, the air conditioner automatically adjusts the fan speed according to room temperature.
FAN	In FAN mode, the unit will not operate in COOL or HEAT mode but only in FAN mode, AUTO is not available in FAN mode. And temp. setting is disabled. In FAN mode, Sleep operation is not available.

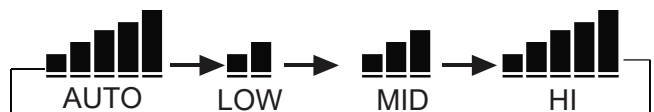
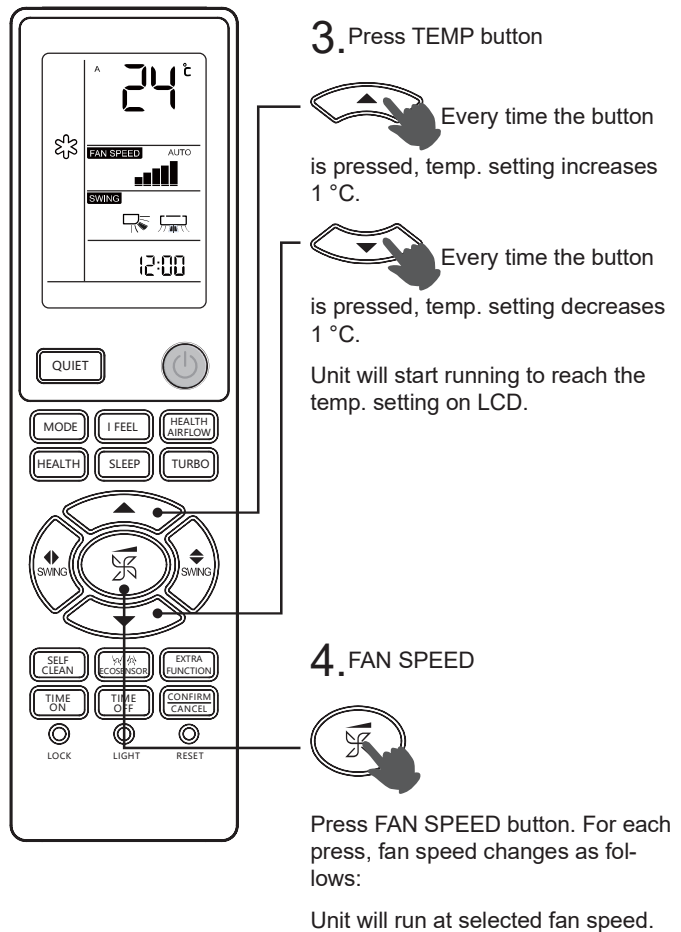

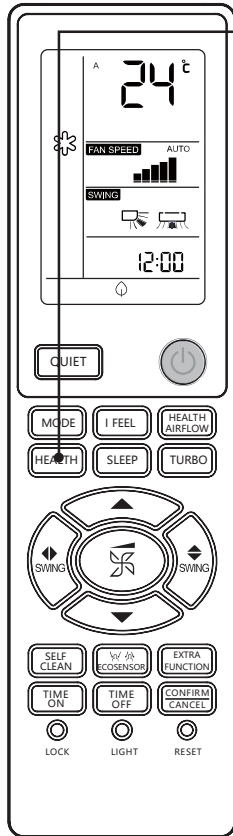

Operation

HEALTH Operation



HEALTH Press HEALTH button

1. For each press,  is displayed. Air conditioner starts health function operation.
2. Press HEALTH button for twice press,  disappears, the operation stops.

UV sterilization function:

It uses the c-band with the most effective sterilization effect in ultra-violet radiation to remove harmful micro-organisms such as bacteria in the air, which has remarkable effects to make the air healthy.

I FEEL Operation

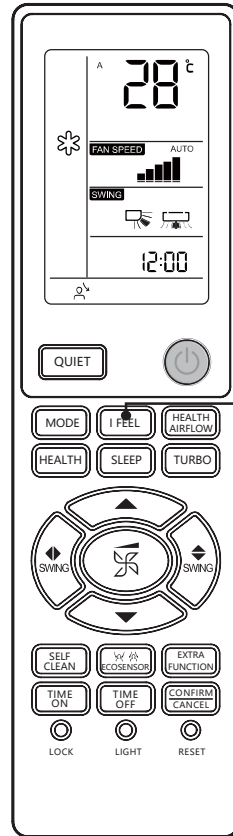

I FEEL Press I FEEL button

1. Only for COOLING, HEATING or AUTO mode (other modes cannot be implemented).
2. Place the remote controller within the acceptable range of air conditioner. Press the "**I FEEL**" button, the remote control displays the "" icon. The remote controller sends the circulation temperature data to the indoor unit every 3 minutes, and the air conditioner runs according to this data.
3. Exit "I FEEL" mode when power off, press the "**I FEEL**" button or switch other modes.

English

Attention:

1. It is recommended to turn on the UV sterilization function for 1-2 hours in one day, longer time will affect the life of the UV lamp.
2. Do not look directly at the UV lamp or touch it with your hands when the sterilizing function is on. Please turn off the sterilizing function before opening the panel.
3. Tinged blue light may appear near the air conditioning inlet when the sterilizing function is on.
4. Only when the internal fan has run and health function turned on, the UV lamp will be lighted.

Operation

Comfortable SLEEP

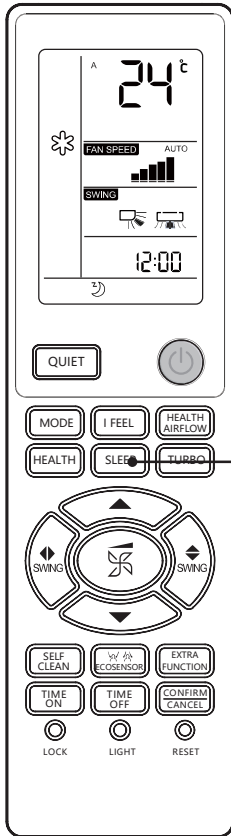

Before going to bed, you can simply press the SLEEP button and unit will operate in SLEEP mode and bring you a sound sleep.



Operation Mode

1. In COOL, DRY mode

1 hour after SLEEP mode starts, temp. will become 1 °C higher than temp. setting. After another 1 hour, temp. will rise by 1 °C further. The unit will run for further 6 hours and then stop. Temp. will be higher than temp. setting so that room temperature won't be too low for your sleep.

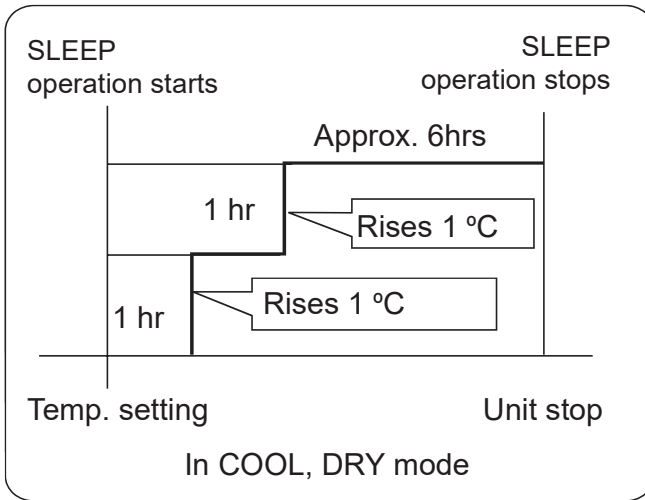

2. In HEAT mode

1 hour after SLEEP mode starts, temp. will become 2 °C lower than temp. setting. After another 1 hour, temp. will decrease by 2 °C further. After more another 3 hours, temp. will rise by 1 °C further. The unit will run for further 3 hours and then stop. Temp. is lower than temp. setting so that room temperature won't be too high for your sleep.

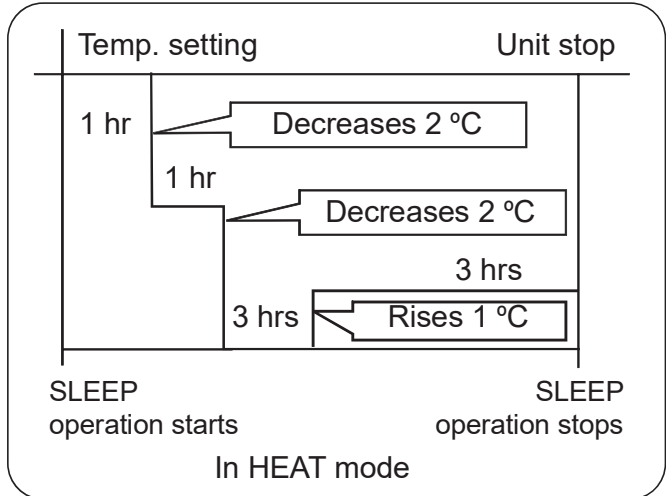

3. In AUTO mode

The unit operates in corresponding SLEEP mode, which adapted to the automatically selected operation mode.

4. In FAN mode

It has no SLEEP function.

5. When quiet sleeping function is set to 8 hours, the quiet sleeping time can not be adjusted. When TIMER function is set, the quiet sleeping function can't be set up. After the sleeping function is set up, if user resets TIMER ON function, the sleeping function will be cancelled, the unit will be in the state of timing-on, if user resets TIMER OFF function, either of their operation time is ended first, the unit will stop automatically, and the other mode will be cancelled.

Note to the power failure resume:

Press the SLEEP button ten times in five seconds and enter function after hearing four sounds. And press the sleep button ten times within five seconds and leave this function after hearing two sounds.

Power Failure Resume Function

If the unit is started for the first time, the compressor will not start running unless 3 minutes have elapsed. When the power resumes after power failure, the unit will run automatically, and 3 minutes later the compressor starts running.

Operation

HEALTH AIRFLOW Operation

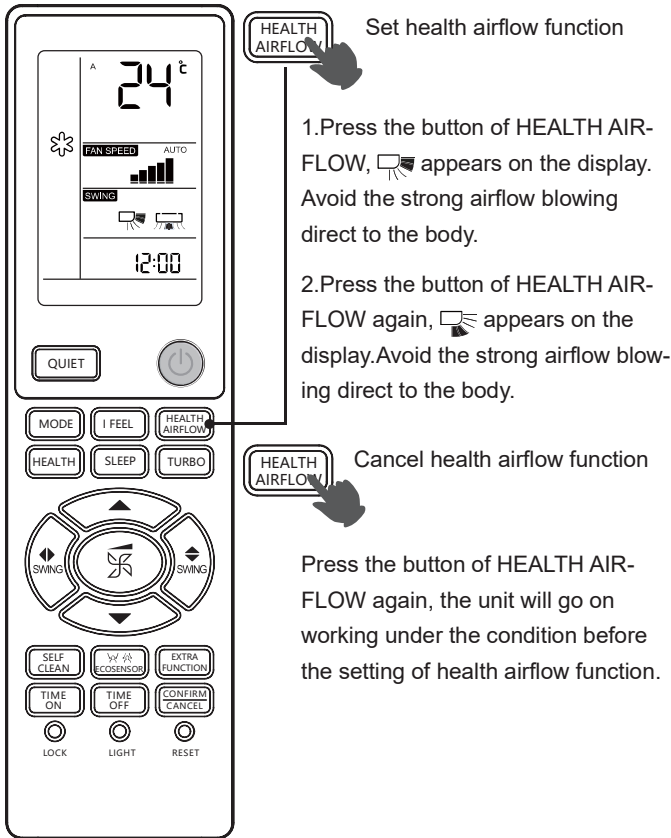

QUIET/TURBO Operation

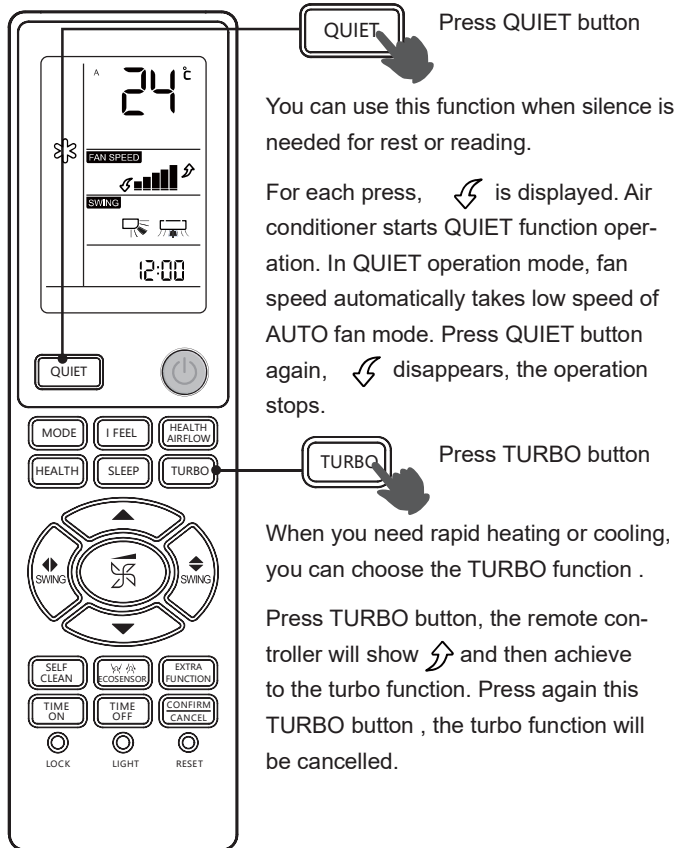

Attention:

1. Do not direct the flap by hand. Otherwise, the grille will run incorrectly. If the grille does not run correctly, stop for a minute and then start, and adjust by using the remote controller.
2. Remote controller can memorize each operation status. When starting it next time, just press ON/OFF button and unit will run in previous status.

When running in Turbo, the fan speed is the highest.

When running in Quiet, the fan speed is super-slow.

NOTE:

During Turbo operation, in rapid HEAT or COOL mode , the room will show inhomogeneous temperature distribution. It will effect desired air temperature that unit is in QUIET operation for a long period.

NOTE:

1. After setting the health airflow function, the position grille is fixed.
2. In heating, it is better to select the mode.
3. In cooling, it is better to select the mode.
4. In cooling and dry, using the air conditioner for a long time under the high air humidity, condensate water may occur at the grille.
5. Select the appropriate fan direction according to the actual conditions.

Operation

SWING Operation

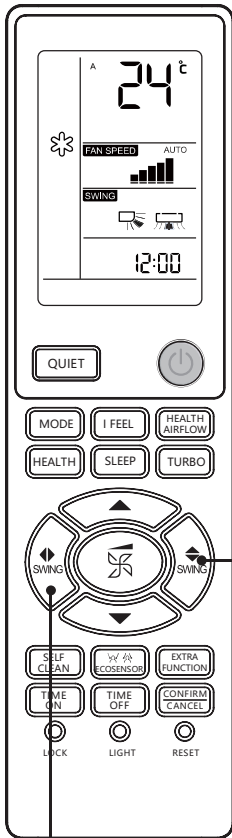

1. Up and down air flow direction



For each press of the button, air flow direction on remote controller displays as follows according to different operation modes:

COOL/DRY/FAN:



HEAT:



AUTO:



Initial state

2. Left and right air flow direction



For each press of the button, air flow direction on remote controller displays as follows :

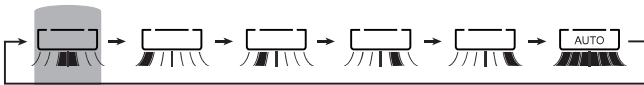

Initial state

NOTE:

1. When humidity is high, condensate water might occur at air outlet if all vertical louvers are adjusted to left or right.
2. It is not advisable to keep horizontal flap at downward position for a long time in COOL or DRY mode, otherwise, condensate water might occur.
3. As cold air flows downward in COOL mode, adjusting air flow horizontally will be much more helpful for a better air circulation.

SELF-CLEAN Operation



Functional description:

The purpose of this function is to clean the evaporator.

Entry and exit:



If this function is needed, please select in the hOn APP.

Press SELF CLEAN button to enter this function. The display will show "CL" on the panel of the indoor unit and on the remote controller. Maximum running time in this function is no more than 21 minutes. This function will exit automatically with the "Pi" sound twice, then the unit return to original state. During SELF CLEAN operation, pressing the button repeatedly will not exit the process. Press ON/OFF button to exit this mode.

NOTE:

1. This function is invalid in TIMER / SLEEP mode.
2. After this mode starts, the air volume may reduce, have no airflow, or even cold airflow blowing.
3. It is normal if the unit makes some sound when the air expands with heat and contracts with cold.
4. The "CL" display time may last differently on the remote controller and panel.
5. If the outside ambient temperature is below zero, error code "F25" may be show up during self-cleaning operation, which is normal protection, please turn off the power and restart after 10 seconds.
6. The best condition to run this mode is temperature is between 20°C~27°C, the humidity is between 35%~60% indoors, and the temperature is between 25°C~38°C (cooling season) outdoors.
7. It is hard for the air to frost if the air is too dry (humidity < 20%). The condensate water may increase if the humidity of the air is too high (humidity > 70%).

Operation

ECO SENSOR Operation

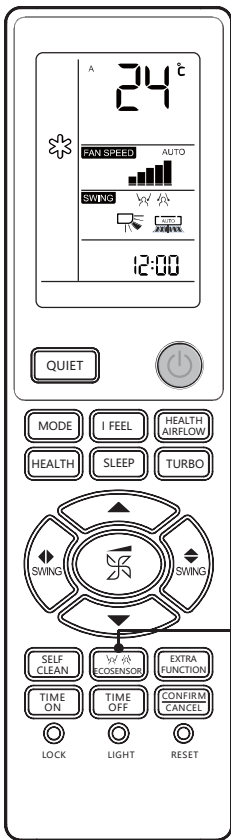

Press ECO SENSOR button

For each press, changes as follows:

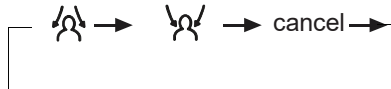

The intelligent sensor can automatically detect your position. Depending on your choice, the unit can adjust the airflow in 2 different settings: "Follow me Mode" setting guarantees that the air flow follows you, while "Avoid Mode" setting will keep the air flow away from you. The Eco Sensor can automatically identify the existence of the human being to improve the user experience. The air conditioner will switch to ECO mode after 20 minutes while nobody is in the room.

TIMER Operation

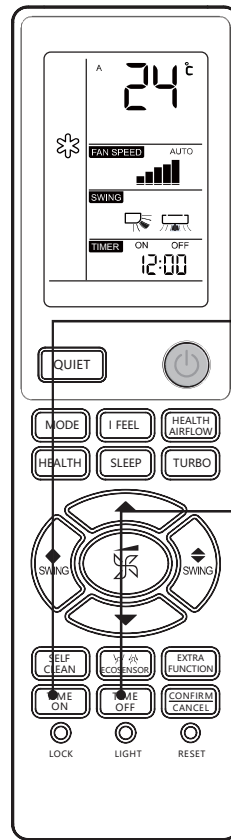

Set Clock correctly before starting Timer operation. You can let unit start or stop automatically at the following times: Before you wake up in the morning, get back from outside or after you fall asleep at night.

1. Select your desired operation mode.

TIME ON Select your desired TIME ON.

Remote controller: "TIMER ON" will flash.

TIME OFF Select your desired TIME OFF.

Remote controller: "TIMER OFF" will flash.

2. Time setting.

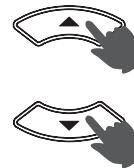

NOTE:

A human sensor is used to detect changes in the infrared radiation emitted by human bodies. In case of the following conditions, the detection may not be accurate:

1. High room temperature, where the ambient temperature is close to body temperature.
2. People wear a lot or lie on their stomach or back.
3. The speed of human movement exceeds the sensitivity of the sensor.
4. Frequent movements of pets, frequent swing of curtains or other indoor objects due to the wind.
5. Moving targets go beyond the detection range of the sensor.
6. The left and right ends of the indoor unit are installed too close to the wall.
7. There is direct sunlight inside the room.
8. The air conditioner operates in a room where ambient temperature fluctuates sharply.

Besides, if a person is at the border of two air blowing areas, the following air will be sent to these two areas respectively or be swept automatically. The avoiding air will avoid these two areas or be swept automatically.

Every time the button is pressed, time setting increases or decreases 1 min, if kept pressed, it will increase rapidly. It can be adjusted within 24 hours.

3. Confirm timer setting

CONFIRM CANCEL After adjust the time, press the button and confirm the time ON or OFF button will not flash any more.

4. Cancel timer setting

CONFIRM CANCEL Press the button, the time display eliminated.

NOTE:

After replacing batteries or a power failure happens, time setting should be reset. According to the time setting sequence of TIME ON or TIME OFF, either Start-Stop or Stop-Start can be achieved.

Operation

Wi-Fi function description

The system architecture diagram

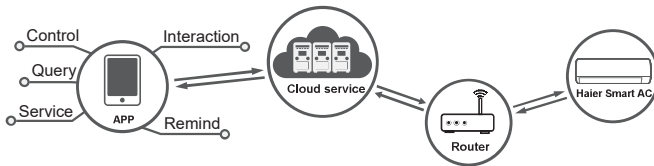

The application environment

Smart mobile phone and wireless router are necessary for the application.

Wireless router must be able to connect to the Internet.

Smart mobile phone requires IOS or Android system:



IOS system must support IOS 9.0 or above



Android system must support Android 5.0 or above

Configuration method

Scan the QR code below to download "hOn" APP. Other Download options: Please search hOn APP on:

- App Store (IOS)
- Google Play (Android)
- Huawei AppGallery (Android)

After App Download, please register, connect the air conditioner and enjoy using hOn to manage your device. Please refer to the HELP section inside the APP for more details about how to register, connect the unit, and other operations



ON/OFF operation and test operation

ON/OFF Operation:

- Use this operation only when the remote controller is defective or lost, and with function of emergency running, air conditioner can run automatically for a while.
- When the emergency operation switch is pressed, the "Pi" sound is heard once, which means the start of this operation.
- When power switch is turning on for the first time and emergency operation starts, the unit will run automatically in the following modes:

Room temperature	Designated temperature	Timer mode	Fan speed	Operation mode
Above 24 °C	24 °C	No	AUTO	COOL
Below 24 °C	24 °C	No	AUTO	HEAT

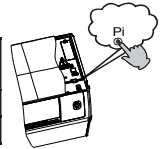

- It is impossible to change the settings of temp. and fan speed. It is also not possible to operate in TIMER or DRY mode.

Test operation:

Test operation switch is the same as emergency switch.

- Use this switch in the test operation when the room temperature is below 16 °C, do not use it in the normal operation.
- Continue to press the test operation switch for more than 5 seconds. After you hear the "Pi" sound twice, release your finger from the switch: the cooling operation starts with the air flow speed "Hi".

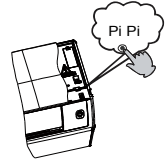

Operation

■ Steri Clean Operation

When the 56°C Steri-clean function is required, please access in the hOn APP.

Introduction to Steri Clean

Stage 1 - Self Clean: to remove dirt away. This function freezes the evaporator with moisture in the air, and removes dirt during the melting process. The hydrophilic aluminium coating with smaller angel ($\alpha \approx 5^\circ$) helps increase water drainage efficiency.

Stage 2 - 56°C high temperature sterilisation: It utilizes smart temperature monitoring and frequency control technology to adjust the compressor operation, so that we maintain the evaporator temperature at high temperature for over 30mins to kill any bacteria and virus inside the air conditioner.

Stage 3 - Rapid evaporator cooling to enhance the sterilisation performance. The foil surface is coated with silver nano-particles which has an anti-bacterial efficiency up to 99%.

Attention:

1. The function lasts 60-80 minutes.
2. Hot air may come out during the process when evaporator is heated to 56°C or maintains at 56°C in summer.
3. This function may cause changes in room air temperature in winter.
4. When outdoor ambient temperature is above 36°C, the function cannot be performed. Instead, Self Clean function will be turned on and lasts 21mins when Steri Clean is turned on.

■ Loading of the battery

1



Remove the battery cover;

2



Load the batteries as illustrated. 2 R-03 batteries, resetting key (cylinder); Be sure that the loading is in line with the “+”/“-”;

3



Load the battery, then put on the cover again.

IMPORTANT INFORMATION REGARDING THE REFRIGERANT USED

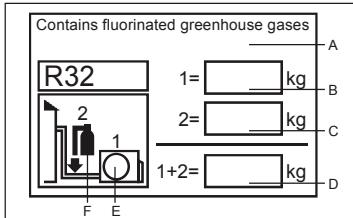

This product contains fluorinated greenhouse gases. Do not vent into the atmosphere.

Refrigerant type: R32

GWP* value: 675

GWP = global warming potential

Please fill in with indelible ink,

- 1 the factory refrigerant charge of the product
- 2 the additional refrigerant amount charged in the field and
- 1+2 the total refrigerant charge

on the refrigerant charge label supplied with the product. The filled out label must be adhered in the proximity of the product charging port (e.g. onto the inside of the stop valve cover).

A contains fluorinated greenhouse gases

B factory refrigerant charge of the product: see unit name plate C

additional refrigerant amount charged in the field

D total refrigerant charge

E outdoor unit

F refrigerant cylinder and manifold for charging

EUROPEAN REGULATIONS CONFORMITY FOR THE MODELS

Climate: T1 Voltage: 220-240V

CE

All the products are in conformity with the following

European provision:

- 2014/53/EU (RED)
- 2014/517/EU (F-GAS)
- 2009/125/EC (ENERGY)
- 2010/30/EU (ENERGY)
- 2006/1907/EC (REACH)

RoHS

The products are fulfilled with the requirements in the directive 2011/65/EU of the European parliament and of council on the Restriction of the use of Certain Hazardous Substances in Electrical and Electronic Equipment (EU RoHS Directive)

WEEE

In accordance with the directive 2012/19/EU of the European parliament, herewith we inform the consumer about the disposal requirements of the electrical and electronic products.

DISPOSAL REQUIREMENTS:



Your air conditioning product is marked with this symbol. This means that electrical and electronic products shall not be mixed with unsorted household waste. Do not try to dismantle the system yourself: the dismantling of the air conditioning system, treatment of the refrigerant, of oil and of other part must be done by a qualified installer in accordance with relevant local and national legislation. Air conditioners must be treated at a specialized treatment facility for reuse, recycling and recovery. By ensuring this product is disposed of correctly, you will help to prevent potential negative consequences for the environment and human health. Please contact the installer or local authority for more information. Battery must be removed from the remote controller and disposed of separately in accordance with relevant local and national legislation.

Wi-Fi

- Wireless maximum transmit power (20dBm)
- Wireless operating frequency range (2400~2483.5MHz)
- Support standards: IEEE 802.11b, IEEE 802.11g, IEEE 802.11n

Indoor Unit Installation

Necessary Tools for Installation

- Driver
- Nipper
- Hacksaw
- Hole core drill
- Spanner(17,19 and 26mm)
- Gas leakage detector or soap-and-water solution
- Torque wrench (17mm,22mm,26mm)
- Pipe cutter
- Flaring tool
- Knife
- Measuring tape
- Reamer

Power Source

- Before inserting power into receptacle, check the voltage without fail.
- The power supply is the same as the corresponding nameplate.
- Install an exclusive branch circuit of the power.
- A receptacle shall be set up in a distance where the power cable can be reached. Do not extend the cable by cutting it.

Selection of Installation Place

English

- Place, robust not causing vibration, where the body can be supported sufficiently.
- Place, not affected by heat or steam generated in the vicinity, where inlet and outlet of the unit are not disturbed.
- Place, possible to drain easily, where piping can be connected with the outdoor unit.
- Place, where cold air can be spread in a room entirely.
- Place, nearby a power receptacle, with enough space around.
- Place where the distance of more than 1m from televisions, radios, wireless apparatuses and fluorescent lamps can be left.
- In the case of fixing the remote controller on a wall, place where the indoor unit can receive signals when the fluorescent lamps in the room are lightened.

Drawing for the installation of indoor units

The models adopt HFC refrigerant R32

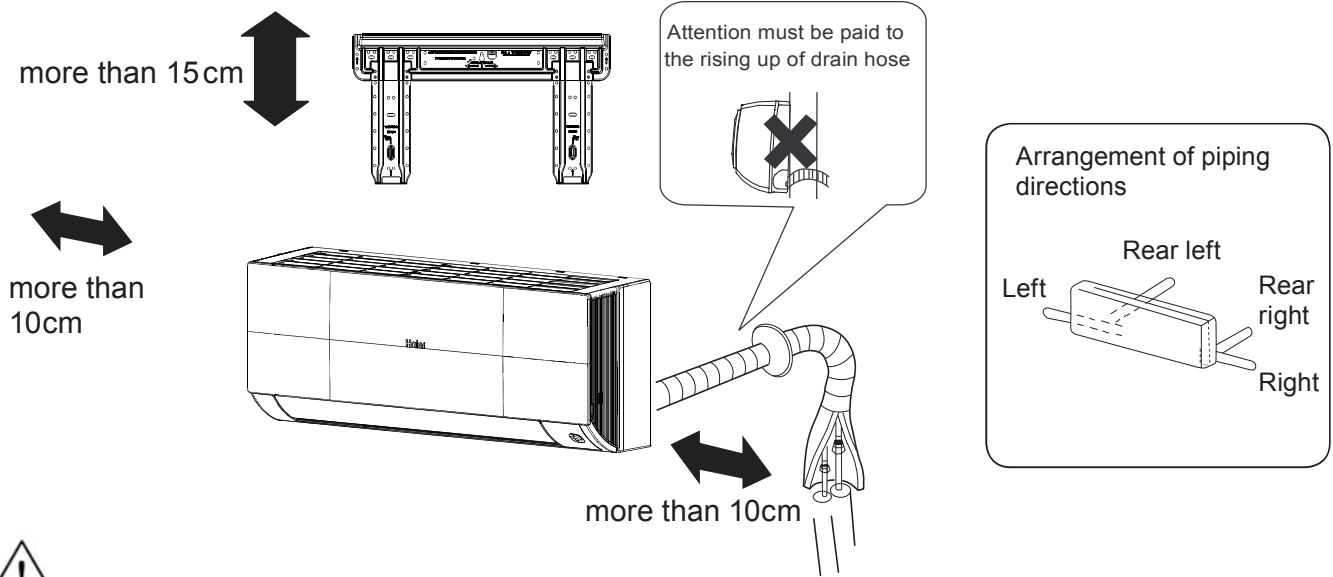

If using the left side drain pipe, make sure the hole is got through.

The distance between the indoor unit and the floor should be more than 2m.

Please be subject to the actual product purchased, the above picture is just for your reference.

Indoor Unit Installation

1 Fitting of the Mounting Plate and Positioning of the wall Hole

When the mounting plate is first fixed

1. Carry out, based on the neighboring pillars or lintels, a proper leveling for the plate to be fixed against the wall, then temporarily fasten the plate with one steel nail.
2. Make sure once more the proper level of the plate, by hanging a thread with a weight from the central top of the plate, then fasten securely the plate with the attachment steel nail.
3. Find the wall hole location A/C using a measuring tape

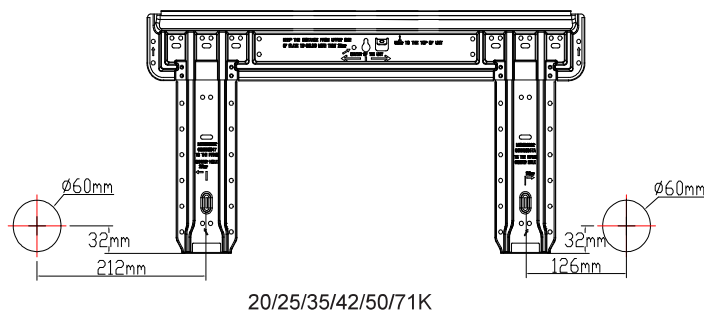

When the mounting plate is fixed side bar and lintel

- Fix to side bar and lintel a mounting bar, Which is separately sold, and then fasten the plate to the fixed mounting bar.
- Refer to the previous article, "When the mounting plate is first fixed", for the position of wall hole.

2 Making a Hole on the Wall and Fitting the Piping Hole Cover

- Make a hole of 60 mm in diameter, slightly descending to outside the wall
- Install piping hole cover and seal it off with putty after installation

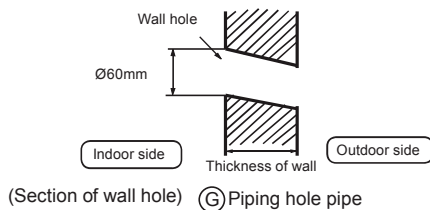

3 Installation of the Indoor Unit

Drawing of pipe

[Rear piping]

- Draw pipes and the drain hose, then fasten them with the adhesive tape

[Left • Left-rear piping]

- In case of left side piping, cut away, with a nipper, the lid for left piping.
 - In case of left-rear piping, bend the pipes according to the piping direction to the mark of hole for left-rear piping which is marked on heat insulation materials.
1. Insert the drain hose into the dent of heat insulation materials of indoor unit.
 2. Insert the indoor/outdoor electric cable from backside of indoor unit, and pull it out on the front side, then connect them.
 3. Coat the flaring seal face with refrigerant oil and connect pipes. Cover the connection part with heat insulation materials closely, and make sure fixing with adhesive tape

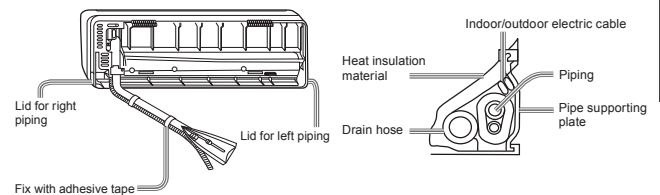

- Indoor/outdoor electric cable and drain hose must be bound with refrigerant piping by protecting tape.

[Other direction piping]

- Cut away, with a nipper, the lid for piping according to the piping direction and then bend the pipe according to the position of wall hole. When bending, be careful not to crash pipes.
- Connect beforehand the indoor/outdoor electric cable, and then pull out the connected to the heat insulation of connecting part specially.

Fixing the indoor unit body

- Hang surely the unit body onto the upper notches of the mounting plate. Move the body from side to side to verify its secure fixing.
- In order to fix the body onto the mounting plate, hold up the body aslant from the underside and then put it down perpendicularly. mounting plate

Unloading of indoor unit body

- When you unload the indoor unit, please use your hand to arise the body to leave agraffe, then lift the bottom of the body outward slightly and lift the unit aslant until it leaves the mounting plate.

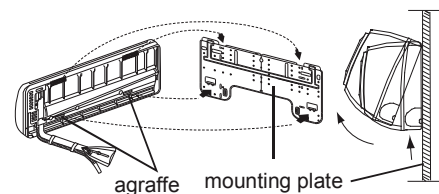

4 Connecting the indoor/outdoor Electric Cable

Removing the wiring cover

- Remove terminal cover at right bottom corner of indoor unit, then take off wiring cover by removing its screws.

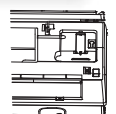

When connecting the cable after installing the indoor unit

1. Insert from outside the room cable into left side of the wall hole, in which the pipe has already existed.
2. Pull out the cable on the front side, and connect the cable making a loop.

When connecting the cable before installing the indoor unit

- Insert the cable from the back side of the unit, then pull it out on the front side.
- Loosen the screws and insert the cable ends fully into terminal block, then tighten the screws.
- Pull the cable slightly to make sure the cables have been properly inserted and tightened.
- After the cable connection, never fail to fasten the connected cable with the wiring cover.

English

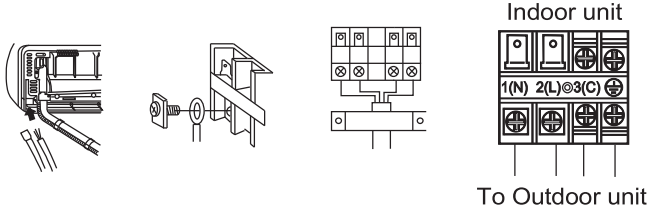

Note:

When connecting the cable, confirm the terminal number of indoor and outdoor units carefully. If wiring is not correct, proper operation can not be carried out and will cause defect.

Connecting wiring	4G1.0mm ²
-------------------	----------------------

1. If the supply cord is damaged, it must be replaced by the manufacturer or its service agent or a similar qualified person. The type of connecting wire is H05RN-F or H07RN-F.
2. If the fuse on PC board is broken please change it with the type of T.3.15A/250VAC (Indoor).
3. The wiring method should be in line with the local wiring standard.
4. After installation, the power plug should be easily reached.
5. A breaker should be incorporated into fixed wiring. The breaker should be all-pole switch and the distance between its two contacts should be not less than 3mm.

5 Power Source Installation

- The power source must be exclusively used for air conditioner.
- In the case of installing an air conditioner in a moist place, please install an earth leakage breaker.
- For installation in other places, use a circuit breaker as far as possible.

6 Cutting and Flaring Work of Piping

- Pipe cutting is carried out with a pipe cutter and burs must be removed.
- After inserting the flare nut, flaring work is carried out.

	Flare tool for R410A	Conventional flare tool	
	Clutch-type	clutch-type(Rigid-type)	Wing-nut type (Imperial-type)
A	0~0.5mm	1.0~1.5mm	1.5~2.0mm

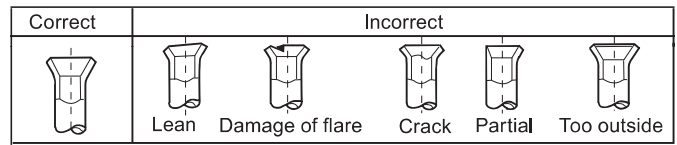
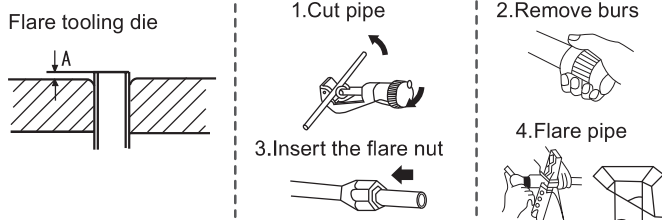

7 On Drainage

- Please install the drain hose so as to be downward slope without fail.
- Please don't do the drainage as shown below.

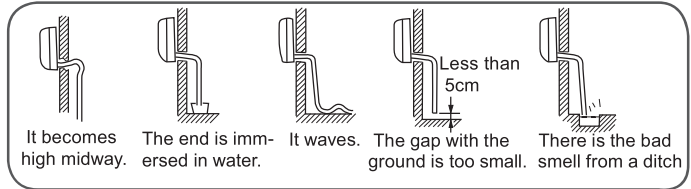

- Please pour water in the drain pan of the indoor unit, and confirm that drainage is carried out surely to outdoor.
- In case that the attached drain hose is in a room, please apply heat insulation to it without fail.

8 On Drainage

Code indication	Trouble description	Analyze and diagnose
E1	Room temperature sensor failure	Faulty connector connection; Faulty thermistor;
E2	Heat-exchange sensor failure	Faulty PCB;
E4	Indoor EEPROM error	Faulty EEPROM data; Faulty EEPROM; Faulty PCB;
E7	Communication fault between indoor and outdoor units	Indoor unit- outdoor unit signal transmission error due to wiring error; Faulty PCB;
E14	Indoor fan motor malfunction	Operation halt due to breaking of wire inside the fan motor; Operation halt due to breaking of the fan motor lead wires; Detection error due to faulty indoor unit PCB;

9 Check for Installation and Test Run

- Please kindly explain to our customers how to operate through the instruction manual.





Check Items for Test Run

Put check mark ✓ in boxes

- Gas leak from pipe connecting?
- Heat insulation of pipe connecting?
- Are the connecting wirings of indoor and outdoor firmly inserted to the terminal block?
- Is the connecting wiring of indoor and outdoor firmly fixed?
- Is drainage securely carried out?
- Is the earth line securely connected?
- Is the indoor unit securely fixed?
- Is power source voltage abided by the code?
- Is there any noise?
- Is the lamp normally lighting?
- Are cooling and heating (when in heat pump) performed normally?
- Is the operation of room temperature regulator normal?

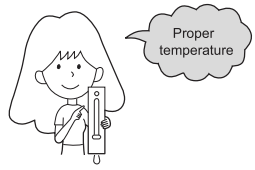
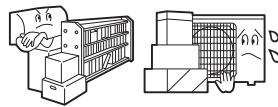
Maintenance

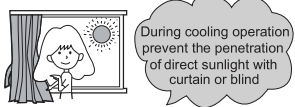
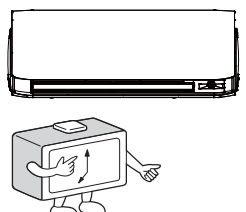
For Smart Use of The Air Conditioner

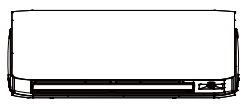
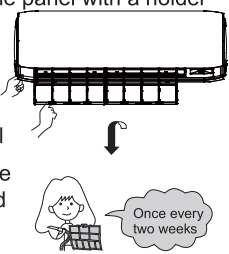
<p>Setting of proper room temperature</p> 	<p>Do not block the air inlet or outlet</p> 	<p>Remote Controller</p>  <p>Do not use water, wipe the controller with a dry cloth. Do not use glass cleaner or chemical cloth.</p>	<p>Indoor Body</p>  <p>wipe the air conditioner by using a soft and dry cloth. For serious stains, use a neutral detergent diluted with water. Wring the water out of the cloth before wiping, then wipe off the detergent completely.</p>
<p>Close doors and windows during operation</p> 	<p>Use the timer effectively</p> 	<p>Do not use the following for cleaning</p>  <p>Gasoline, benzene, thinner or cleanser may damage the coating of the unit. Hot water over 40°C (104°F) may cause discoloring or deformation.</p>	
<p>If the unit is not to be used for a long time, turn off the power supply main switch.</p> 	<p>Use the louvers effectively</p> 	<p>Air Filter cleaning</p> <ol style="list-style-type: none"> 1 Press the "SMART" button for 5s to partially raise the panel. 2 Open the panel by hand and support the panel with a holder 3 Remove the filter 4 Clean the filter 5 Fit the filter 6 Remove the holder and close the panel 7 Long press the "SMART" button and the panel will automatically lower down and become closed  <p>Once every two weeks</p>	

English

Replacement of Air Purifying Filter

1. Open the Inlet Grille

Press the "SMART" button for 5s to partially raise the panel.



2. Detach the standard air filter

Slide the knob slightly upward to release the filter, then withdraw it.

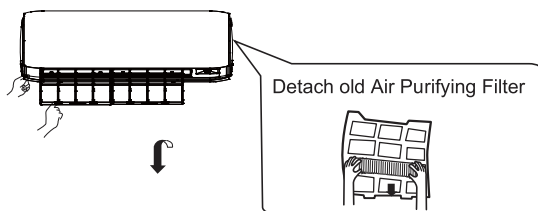

3. Attach Air Purifying Filter

Put air purifying filter appliances into the right and left filter frames.

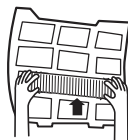

4. Attach the standard air filter

(Necessary installation)

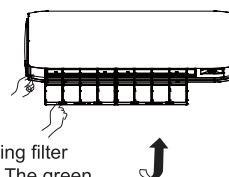

ATTENTION:

The white side of the photocatalyst air purifying filter face outside, and the black side face the unit. The green side of the bacteria-killing medium air purifying filter face outside, and the white side face the unit.

5. Close the Inlet Grille

Long press the "SMART" button and the panel will automatically lower down and become closed.

NOTE:

- The photocatalyst air purifying filter will be solarized in fixed time. In normal family, it will be solarized every 6 months.
- The bacteria-killing medium air purifying filter will be used for a long time, no need for replacement. But in the period of using them, you should remove the dust frequently by using vacuum cleaner or flapping them lightly, otherwise, its performance will be affected.
- Please keep the bacteria-killing medium air purifying filter in the cool and dry conditions avoid long time directly sunshine when you stop using it, or its ability of sterilization will be reduced.

Essay maintenance (Ask your dealer or qualified personnel to carry out installation work.)

1. Open the panel,uncover the clasp and remove the two screw

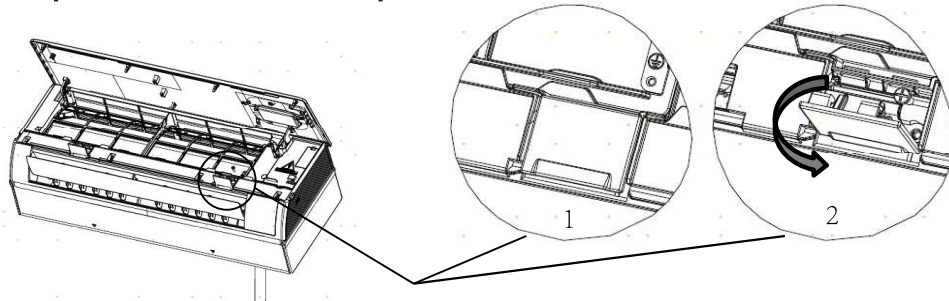

2. tilt the blade ,grab the corner and remove the bottom cover

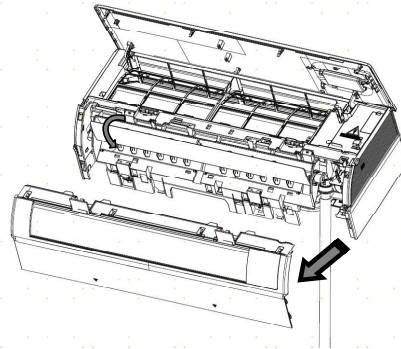

3.unplug the waterpipe and terminals

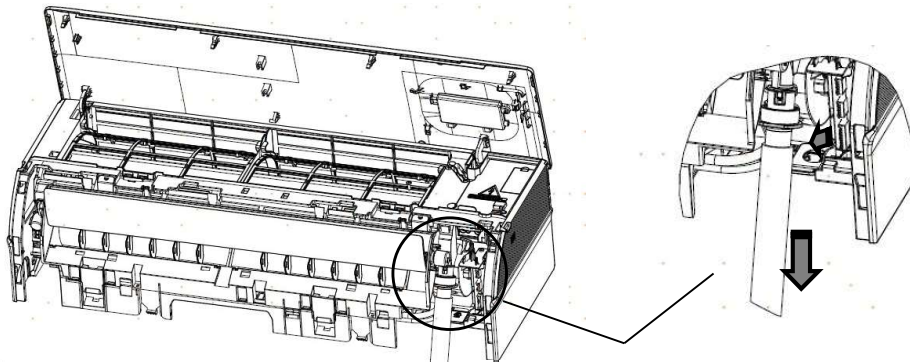

4. open the bottom “A” clasp to this angle and then uncover the “B” clasp to take out cross fan and motor

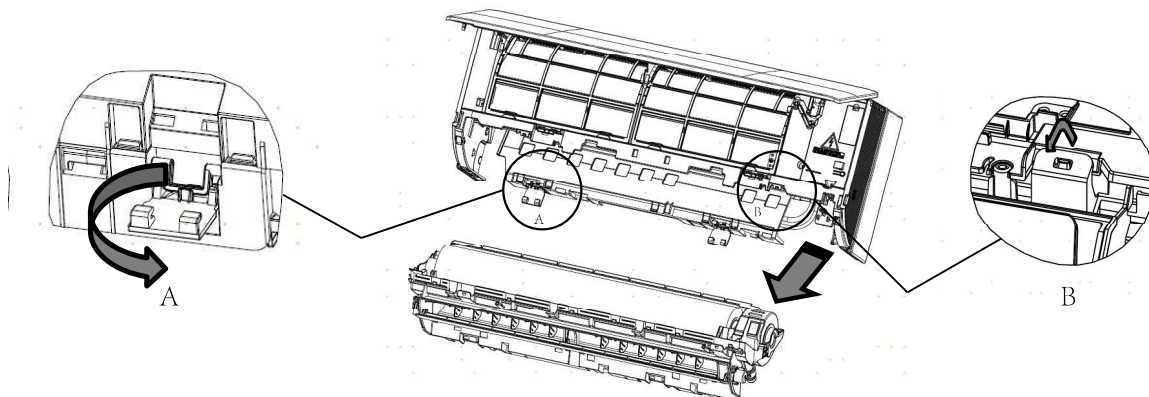

Cautions

⚠ WARNING

Please call Sales/Service Shop for the Installation.

Do not attempt to install the air conditioner by yourself because improper works may cause electric shock, fire, water leakage.

⚠ WARNING

When abnormality such as burnt-small found, immediately stop the operation button and contact sales shop.

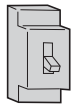

OFF



STRICT ENFORCEMENT

Use an exclusive power source with a circuit breaker

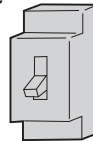

Check proper installation of the drainage securely



STRICT ENFORCEMENT

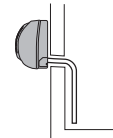

Connect power supply cord to the outlet completely



STRICT ENFORCEMENT

Use the proper voltage



STRICT ENFORCEMENT

1. Do not use power supply cord extended or connected in halfway
2. Do not install in the place where there is any possibility of inflammable gas leakage around the unit.
3. Do not get the unit exposed to vapor or oil steam.



PROHIBITION

Do not use power supply cord in a bundle.

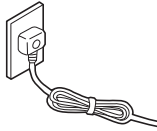

PROHIBITION

Take care not to damage the power supply cord.

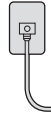

PROHIBITION

Do not insert objects into the air inlet or outlet.

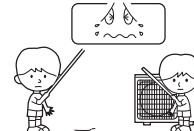

PROHIBITION

Do not start or stop the operation by disconnecting the power supply cord and so on.



PROHIBITION

Do not channel the air flow directly at people, especially at infants or the aged.



PROHIBITION

Do not try to repair or reconstruct by yourself.

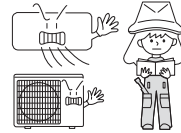

Connect the earth cable.



earthing

⚠ CAUTION

Do not use for the purpose of storage of food, art work, precise equipment, breeding, or cultivation.



PROHIBITION

Take fresh air occasionally especially when gas appliance is running at the same time.

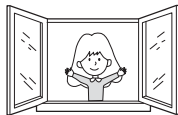

STRICT ENFORCEMENT

Do not operate the switch with wet hand.

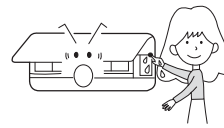

PROHIBITION

Do not install the unit near a fireplace or other heating apparatus.

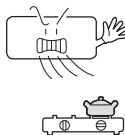

PROHIBITION

Check good condition of the installation stand

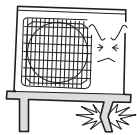

PROHIBITION

Do not pour water onto the unit for cleaning

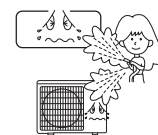

PROHIBITION

Do not place animals or plants in the direct path of the air flow

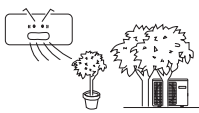

PROHIBITION

Do not place any objects on or climb on the unit.

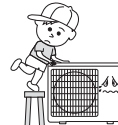

PROHIBITION

Do not place flower vase or water containers on the top of the unit.







PROHIBITION

Trouble shooting

Before asking for service, check the following first.

English

	Phenomenon	Cause or check points
Normal Performance inspection	The system does not restart immediately. 	<ul style="list-style-type: none"> When unit is stopped, it won't restart immediately until 3 minutes have elapsed to protect the system. When the electric plug is pulled out and reinserted, the protection circuit will work for 3 minutes to protect the air conditioner.
	Noise is heard 	<ul style="list-style-type: none"> During unit operation or at stop, a swishing or gurgling noise may be heard. At first 2-3 minutes after unit start, this noise is more noticeable. (This noise is generated by refrigerant flowing in the system.) During unit operation, a cracking noise may be heard. This noise is generated by the casing expanding or shrinking because of temperature changes. Should there be a big noise from air flow in unit operation, air filter may be too dirty.
	Smells are generated.	<ul style="list-style-type: none"> This is because the system circulates smells from the interior air such as the smell of furniture, paint, cigarettes.
	Mist or steam are blown out. 	<ul style="list-style-type: none"> During COOL or DRY operation, indoor unit may blow out mist. This is due to the sudden cooling of indoor air.
	In dry mode, fan speed can't be changed.	<ul style="list-style-type: none"> In DRY mode, when room temperature becomes lower than temp. setting+2 °C, unit will run intermittently at LOW speed regardless of FAN setting.
Multiple check		<ul style="list-style-type: none"> Is power plug inserted? Is there a power failure? Is fuse blownout?
	Poor cooling 	<ul style="list-style-type: none"> Is the air filter dirty? Normally it should be cleaned every 15 days. Are there any obstacles before inlet and outlet? Is temperature set correctly? Are there some doors or windows left open? Is there any direct sunlight through the window during the cooling operation? (Use curtain) Are there too much heat sources or too many people in the room during cooling operation?

Cautions

- Do not obstruct or cover the ventilation grille of the air conditioner. Do not put fingers or any other things into the inlet/outlet and swing louver.
- This appliance is not intended for use by persons (including children) with reduced physical, sensory or mental capabilities or lack of experience and knowledge, unless they have been given supervision or instruction concerning use of appliance by person responsible for their safety. Children should be supervised to ensure that they do not play with the appliance.

Specifications

- The refrigerating circuit is leak-proof.

The machine is adaptive in following situation

1. Applicable ambient temperature range:

Cooling	Indoor	Maximum: D.B/W.B 35°C/24°C Minimum: D.B/W.B 21°C/15°C
	Outdoor	Maximum: D.B/W.B 43°C/26°C Minimum: D.B -20°C
Heating	Indoor	Maximum: D.B 27°C Minimum: D.B 10°C
	Outdoor	Maximum: D.B/W.B 24°C/18°C Minimum: D.B -15°C
	Outdoor (INVERTER)	Maximum: D.B/W.B 24°C/18°C Minimum: D.B -20°C

- If the power supply cord is damaged, it must be replaced by the manufacturer or its service agent or a similar qualified person.
- If the fuse of indoor unit on PC board is broken, please change it with the type of T. 3.15A/250V. If the fuse of outdoor unit is broken, change it with the type of T.25A/250V
- The wiring method should be in line with the local wiring standard.
- After installation, the power plug should be easily reached.
- The waste battery should be disposed properly.
- The appliance is not intended for use by young children or infirm persons without supervision.
- Young children should be supervised to ensure that they do not play with the appliance.
- Please employ the proper power plug, which fit into the power supply cord.
- The power plug and connecting cable must have acquired the local attestation.
- In order to protect the units, please turn off the A/C first, and at least 30 seconds later, cutting off the power.

Address: Haier Industrial Park, Haier Road, Hi-Technology Zone, Qingdao City, Shandong Province, P.R. China

Contacts: TEL +86-532-8893-7937

Website: www.haierhvac.eu