

# Haier SERVICE MANUAL

**Wall Mounted Type**

**DC Inverter**

**Model No.1U50S2SQ1FA-NR**

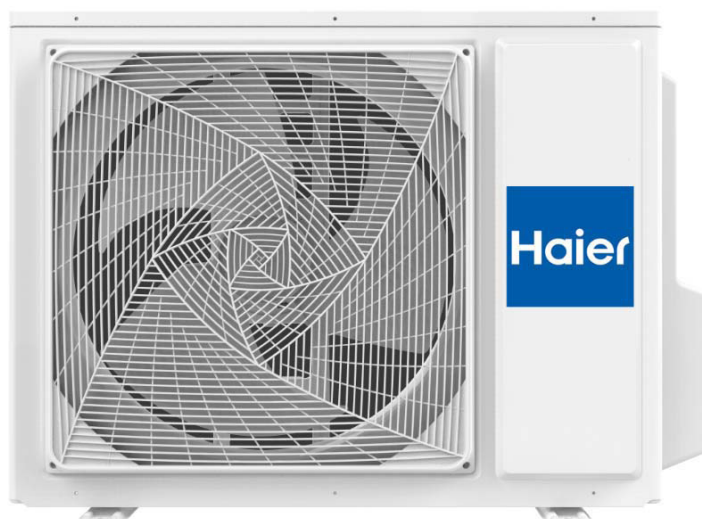

## **! WARNING**

This service information is designed for experienced repair technicians only and is not designed for use by the general public. It does not contain warnings or cautions to advise non-technical individuals of potential dangers in attempting to service a product. Products powered by electricity should be serviced or repaired only by experienced professional technicians. Any attempt to service or Repair the product or products dealt with in this service information by anyone else could result in serious injury or death

2018 (Qingdao Haier Air Conditioner General corp. , Ltd)  
All rights reserved. Unauthorized copying and distribution is a violation of law

**Haier Group**

**Version: V1**

**Date: 2019-04-16**

## Contents

1. Introduction .....	1
2. Specifications.....	7
3. Sensors list .....	8
4. Piping diagrams .....	9
5. Operation range .....	10
6. Printed circuit board connector wiring diagram .....	11
7. Functions and control.....	15
8. Dimensional drawings.....	29
9. Center of gravity .....	29
10. Service diagnosis .....	30
11. Performance and curves diagrams.....	48
12. Circuit diagrams .....	56

# 1. Introduction

## 1.1 Model name explanation

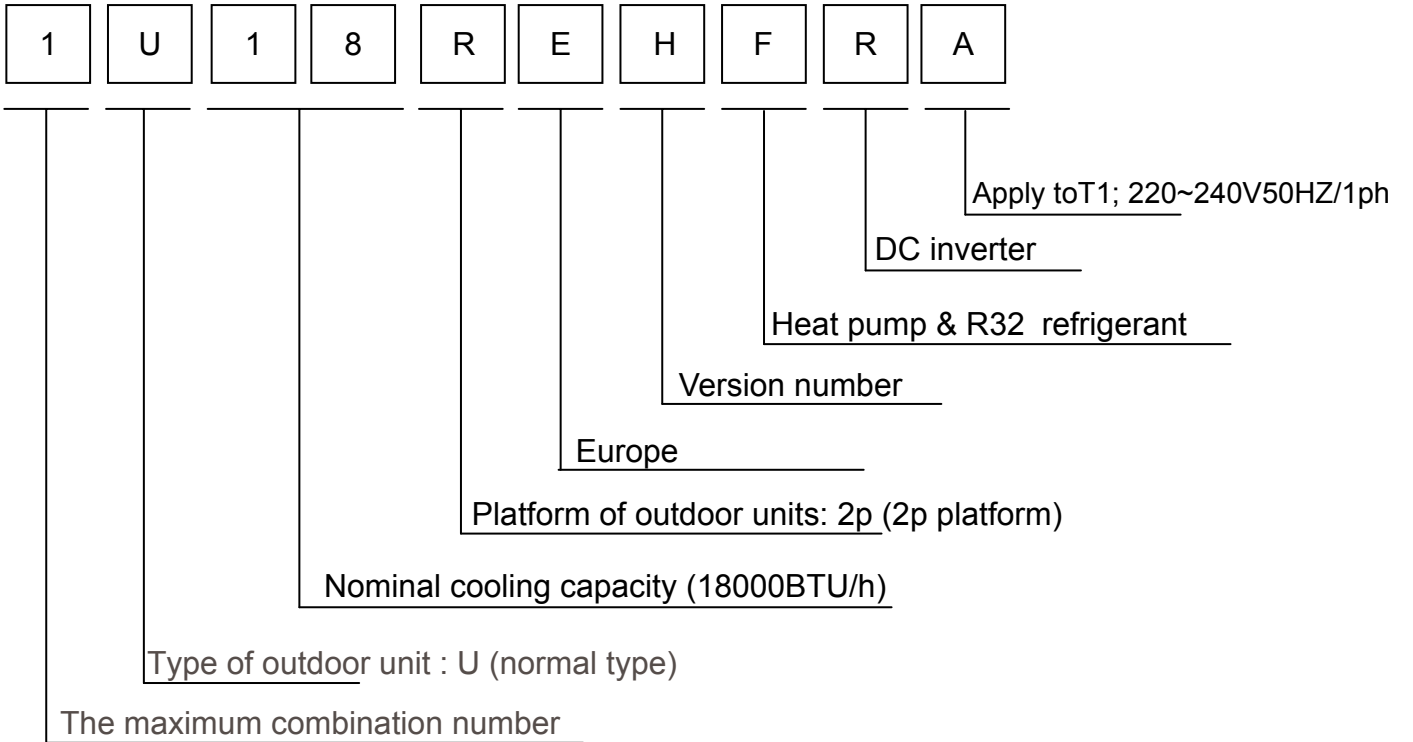

## 1.2 Safety Cautions

Be sure to read the following safety cautions before conducting repair work.

The caution items are classified into “Warning” and “Caution”. The “Warning” items are especially important since they can lead to death or serious injury if they are not followed closely. The “Caution” items can also lead

to serious accidents under some conditions if they are not followed. Therefore, be sure to observe all the safety

caution items described below.

About the pictograms

△ This symbol indicates an item for which caution must be exercised.

The pictogram shows the item to which attention must be paid.

○ This symbol indicates a prohibited action.

The prohibited item or action is shown inside or near the symbol.





● This symbol indicates an action that must be taken, or an instruction.







The instruction is shown inside or near the symbol.

After the repair work is complete, be sure to conduct a test operation to ensure that the equipment operates

Normally, and explain the cautions for operating the product to the customer.



### 1.2.1 Caution in Repair

Warning	
<p>Be sure to disconnect the power cable plug from the plug socket before disassembling the equipment for a repair.</p> <p>Working on the equipment that is connected to a power supply can cause an electrical shock.</p> <p>If it is necessary to supply power to the equipment to conduct the repair or inspecting the circuits, do not touch any electrically charged sections of the equipment.</p>	
<p>If the refrigerant gas discharges during the repair work, do not touch the discharging refrigerant gas. The refrigerant gas can cause frostbite.</p>	
<p>When disconnecting the suction or discharge pipe of the compressor at the welded section, release the refrigerant gas completely at a well-ventilated place first.</p> <p>If there is a gas remaining inside the compressor, the refrigerant gas or cooling machine oil discharges when the pipe is disconnected, and it can cause injury.</p>	
<p>If the refrigerant gas leaks during the repair work, ventilate the area. The refrigerant gas can generate toxic gases when it contacts flames.</p>	
<p>The step-up capacitor supplies high-voltage electricity to the electrical components of the outdoor unit.</p> <p>Be sure to discharge the capacitor completely before conducting repair work. A charged capacitor can cause an electrical shock.</p>	
<p>Do not start or stop the air conditioner operation by plugging or unplugging the power cable plug.</p> <p>Plugging or unplugging the power cable plug to operate the equipment can cause an electrical shock or fire.</p>	

Warning	
Do not repair the electrical components with wet hands . Working on the equipment with wet hands can cause an electrical shock	
Do not clean the air conditioner by splashing water. Washing the unit with water can cause an electrical shock.	
Be sure to provide the grounding when repairing the equipment in a humid or wet place, to avoid electrical shock.	
Be sure to turn off the power switch and unplug the power cable when cleaning the equipment. The internal fan rotates at a high speed, and cause injury.	
Do not tilt the unit when removing it. The water inside the unit can spill and wet the furniture and floor.	
Be sure to check that the cooling cycle section has cooled down sufficiently before conducting repair work. Working on the unit when the cooling cycle section is hot can cause burns.	
Use the welder in a well-ventilated place. Using the welder in an enclosed room can cause oxygen deficiency.	



### 1.2.2 Cautions Regarding Products after Repair

Warning	
Be sure to use parts listed in the service parts list of the applicable model and appropriate tools to conduct repair work. Never attempt to modify the equipment. The use of inappropriate parts or tools can cause an electrical shock, excessive heat generation or fire.	
When relocating the equipment, make sure that the new installation site has sufficient strength to withstand the weight of the equipment. If the installation site does not have sufficient strength and if the installation work is not conducted securely, the equipment can fall and cause injury.	
Be sure to install the product correctly by using the provided standard installation frame. Incorrect use of the installation frame and improper installation can cause the equipment to fall, resulting in injury.	For integral units only
Be sure to install the product securely in the installation frame mounted on a window frame. If the unit is not securely mounted, it can fall and cause injury.	For integral units only

Warning	
<p>Be sure to use an exclusive power circuit for the equipment, and follow the technical standards related to the electrical equipment, the internal wiring regulations and the instruction manual for installation when conducting electrical work.</p> <p>Insufficient power circuit capacity and improper electrical work can cause an electrical shock or fire.</p>	
<p>Be sure to use the specified cable to connect between the indoor and outdoor units. Make the connections securely and route the cable properly so that there is no force pulling the cable at the connection terminals.</p> <p>Improper connections can cause excessive heat generation or fire.</p>	
<p>When connecting the cable between the indoor and outdoor units, make sure that the terminal cover does not lift off or dismount because of the cable.</p> <p>If the cover is not mounted properly, the terminal connection section can cause an electrical shock, excessive heat generation or fire.</p>	
<p>Do not damage or modify the power cable.</p> <p>Damaged or modified power cable can cause an electrical shock or fire. Placing heavy items on the power cable, and heating or pulling the power cable can damage the cable.</p>	
<p>Do not mix air or gas other than the specified refrigerant (R-410A / R22) in the refrigerant system. If air enters the cooling system, an excessively high pressure results, causing equipment damage and injury.</p>	
<p>If the refrigerant gas leaks, be sure to locate the leak and repair it before charging the refrigerant. After charging refrigerant, make sure that there is no refrigerant leak.</p> <p>If the leak cannot be located and the repair work must be stopped, be sure to perform pump-down and close the service valve, to prevent the refrigerant gas from leaking into the room. The refrigerant gas itself is harmless, but it can generate toxic gases when it contacts flames, such as fan and other heaters, stoves and ranges.</p>	
<p>When replacing the coin battery in the remote controller, be sure to disposed of the old battery to prevent children from swallowing it.</p> <p>If a child swallows the coin battery, see a doctor immediately.</p>	

Caution	
<p>Installation of a leakage breaker is necessary in some cases depending on the conditions of the installation site, to prevent electrical shocks.</p>	
<p>Do not install the equipment in a place where there is a possibility of combustible gas leaks. If a combustible gas leaks and remains around the unit, it can cause a fire.</p>	
<p>Be sure to install the packing and seal on the installation frame properly. If the packing and seal are not installed properly, water can enter the room and wet the furniture and floor.</p>	

### 1.2.3 Inspection after Repair

<b>Warning</b>	
<p>Check to make sure that the power cable plug is not dirty or loose, then insert the plug into a power outlet all the way.</p> <p>If the plug has dust or loose connection, it can cause an electrical shock or fire.</p>	
<p>If the power cable and lead wires have scratches or deteriorated, be sure to replace them.</p> <p>Damaged cable and wires can cause an electrical shock, excessive heat generation or fire.</p>	





<b>Warning</b>	
<p>Do not use a joined power cable or extension cable, or share the same power outlet with other electrical appliances since it can cause an electrical shock, excessive heat generation or fire.</p>	

<b>Caution</b>	
<p>Check to see if the parts and wires are mounted and connected properly, and if the connections at the soldered or crimped terminals are secure. Improper installation and connections can cause excessive heat generation, fire or an electrical shock.</p>	
<p>If the installation platform or frame has corroded, replace it. Corroded installation platform or frame can cause the unit to fall, resulting in injury.</p>	
<p>Check the grounding, and repair it if the equipment is not properly grounded. Improper grounding can cause an electrical shock.</p>	
<p>Be sure to measure the insulation resistance after the repair, and make sure that the resistance is 1 M ohm or higher.</p> <p>Faulty insulation can cause an electrical shock.</p>	
<p>Be sure to check the drainage of the indoor unit after the repair.</p> <p>Faulty drainage can cause the water to enter the room and wet the furniture and floor.</p>	

### 1.2.4 Using Icons

Icons are used to attract the attention of the reader to specific information. The meaning of each icon is described in the table below:

## 1.2.5 Using Icons List

Icon	Type of Information	Description
 Note	Note	A “note” provides information that is not indispensable, but may nevertheless be valuable to the reader, such as tips and tricks.
 Caution	Caution	A “caution” is used when there is danger that the reader, through incorrect manipulation, may damage equipment, loose data, get an unexpected result or has to restart (part of) a procedure.
 Warning	Warning	A “warning” is used when there is danger of personal injury.
	Reference	A “reference” guides the reader to other places in this binder or in this manual, where he/she will find additional information on a specific topic.



## 2 .Specifications

NOMINAL DISTRIBUTION SYSTEM VOLTAGE		
Phase	/	1
Frequency	Hz	50
Voltage	V	230

NOMINAL CAPACITY and NOMINAL INPUT			
		cooling	heating
Capacity rated	KW	5.2(1.4-7.0)	6.0(1.5-8.0)
	Btu/h	17740(4780-23880)	20470(5120-27300)
Power Consumption(Rated)	KW	1.44	1.58
SEER/SCOP	W/W	7.4	4.6
Annual energy consumption	KWh	246	1582
Moisture Removal	m <sup>3</sup> /h	2.0*10 <sup>-3</sup>	

TECHNICAL SPECIFICATIONS-UNIT			
Dimensions	H*W*D	mm	890×353x697
Packaged Dimensions	H*W*D	mm	1046x460x780
Weight	/	KG	45.5
Gross weight	/	KG	49.5
Sound level	Sound peessure	dB(A)	53
	Sound power	dB(A)	65

ELECTRICAL SPECIFICATIONS			
		cooling	heating
Nominal running current	A	6.4	7.0
Maximum running current	A	9.8	13.0
Starting current	A	2.5	3.0

TECHNICAL SPECIFICATIONS-PARTS			
		cooling	heating
Compressor	Type	Rotary Compressor	
	Model	SVB140FCAMC	
	Motor output	W	975
	Oil type	Fw68S	
	Oil charge volume	L	0.35
Fan	Type	Axial fan	
	Motor output	W	90
	Air flow rate(high)	m <sup>3</sup> /h	2800
	Speed(high/low)	rpm	900/300
Heat exchanger	Type	ML fin- φ 7HI-HX tube	
	Row*stage*fitch	2*15*1.4	

TECHNICAL SPECIFICATIONS-OTHERS			
Refrigerant circuit	Refrigerant type		R32
	Refrigerant charge	KG	1.2
	Maximum allowable distance between indoor an outdoor	m	25
	Maximum allowable level difference	m	15
	Refrigerant control	EEV	
Piping connections (external diameter)	liquid	mm	Φ6.35
	gas	mm	Φ12.7
	drain	mm	Φ16
Heat insulation type	Both liquid and Gas pipes		
Max. piping Length	m		25
Max. vertical Difference	m		15
Chargeless	m		10
Amount of Additional Charge of Refrigerant	g/m		20
International Protection degree	IP X4		

Note: the data are based on the conditions shown in the table below

cooling	heating	Piping length
Indoor: 27°CDB/19°CWB Outdoor: 35°CDB/24°CWB	Indoor:20°CDB Outdoor: 7°CDB/6°CWB	5m

Conversion formulae

Kcal/h= KW×860

Btu/h= KW×3414

cfm=m<sup>3</sup>/min×35.3

### 3. Sensors list

type	Description	Qty
Ambient sensor	Its used for detecting temperature of outdoor side	1
Defrosting sensor	Its used for controlling outdoor defrosting at heating mode	
Discharging sensor	Its used for compressor in case of over-heat	
Suction sensor	Its used for detecting suction pipe temperature of compressor to adjust gas flowing	1

### 4. Piping diagrams

#### Cooling mode

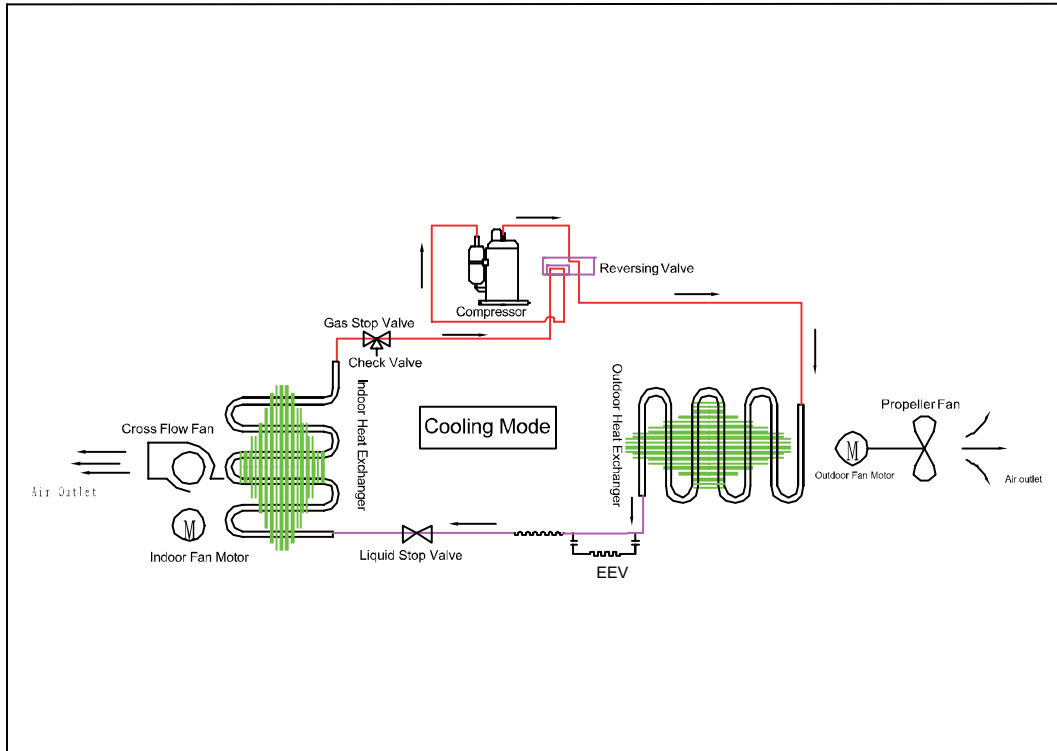

#### Heating mode

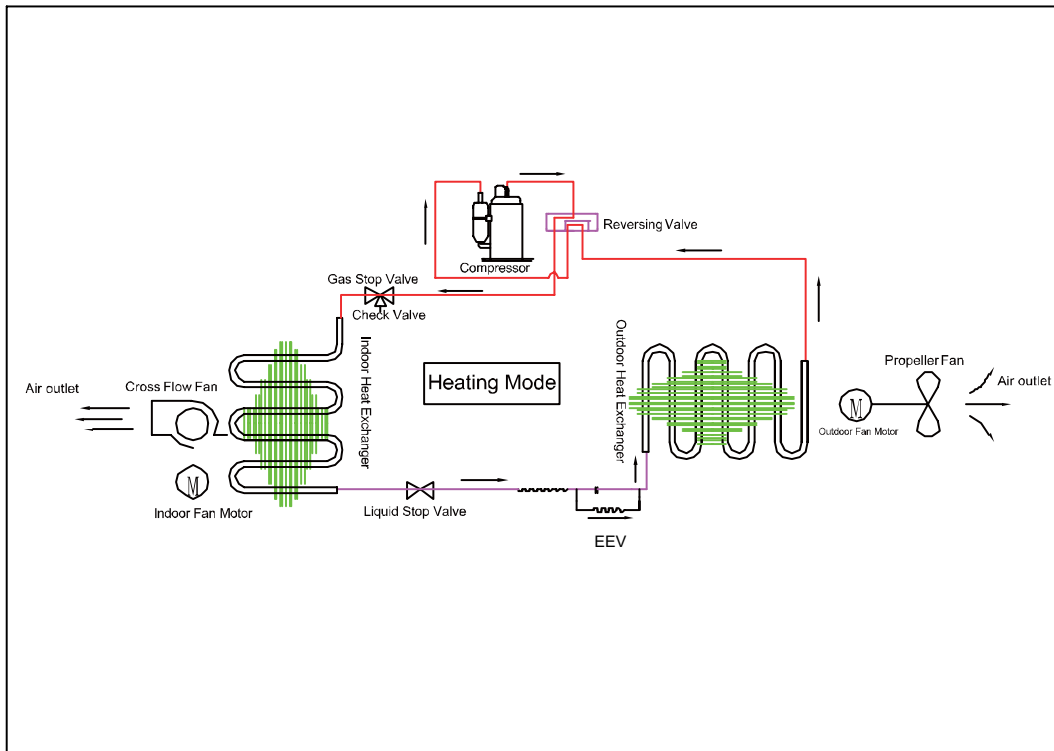

## 5.Operation range

The name of parts

Cooling

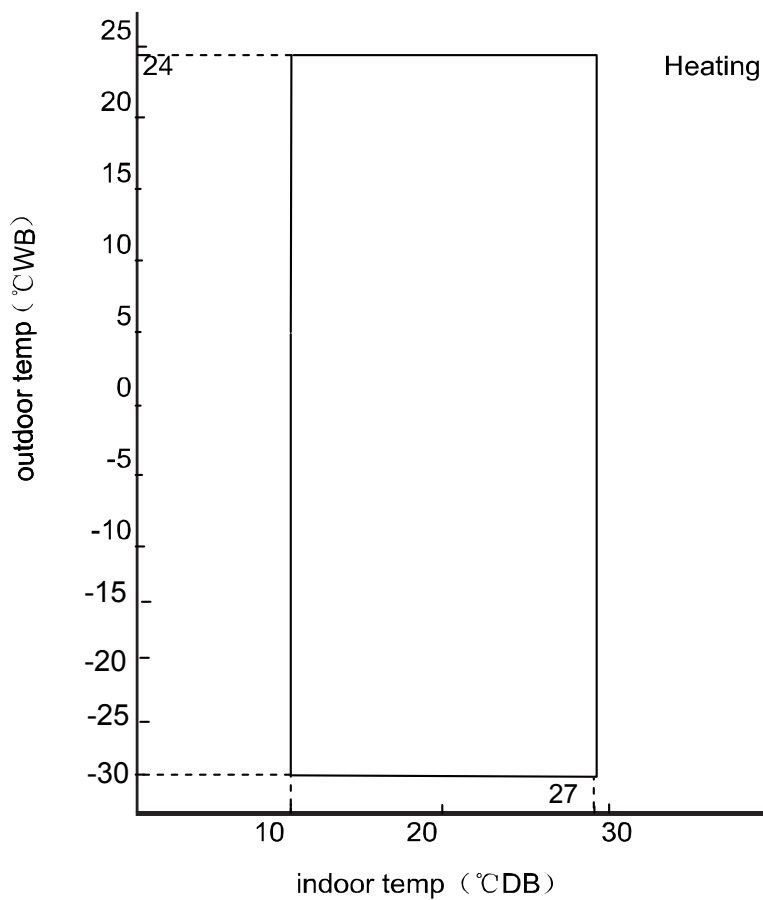
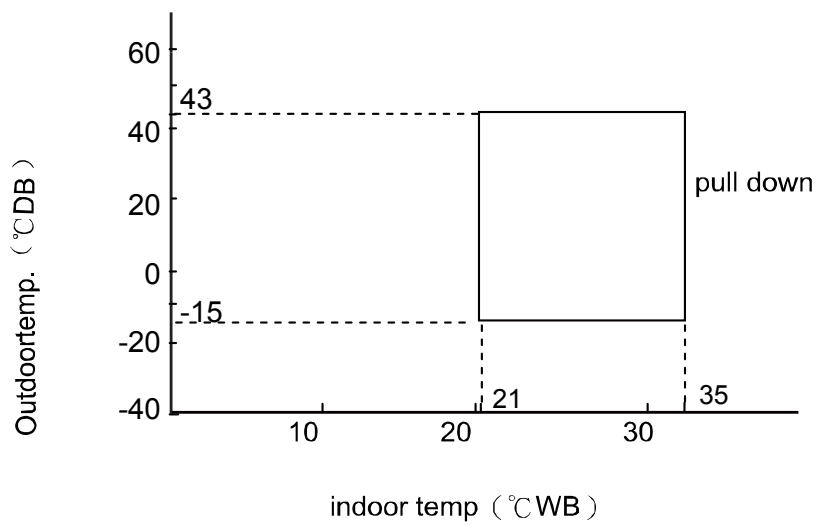

Notes:

The graphs are based on the following condition:

Equivalent piping length	5m
Level difference	0m
Air flow rate	high

## 6. Printed circuit board connector wiring diagram

### Connectors

#### PCB (1) (Control PCB) For 1U18JEFFRA/1U24REFFRA/1U24REBFRA

- 1) CN1, CN2 Connector for power N and L
- 2) CN3 Connector for ground
- 3) CN23 Connector for DC POWER 15V and 5V to the module board
- 4) CN9, CN10 Connector for CN2,CN1 on the module board
- 5) CN22 Connector for fan motor
- 6) CN11 Connector for four way valve coil
- 7) CN17,CN47 Connector for thermistors
- 8) CN24 Connector for communicate between the control board and the module board
- 9) CN25, CN28 Connector to N and P of the module board
- 10) CN36 Connector for communicate between indoor and outdoor unit
- 11) CN15 Connector for electric expansion valves

#### PCB (2) (Module PCB) For 1U18JEFFRA/1U24REFFRA/1U24REBFRA

- CN10 Connector for the DC power 5V and 15V form the control PCB
- CN11 Connector for communicating between the control board and the module board
- P (CN8), N (CN9) Connector for capacitance board
- LI (CN3), LO (CN4) Connector for reactor
- CN5, CN6, CN7 Connector for the U, V, W wire of the compressor

#### Notes: Other Designations

##### PCB (1) (Control PCB)

- 1) FUSE 1, (25A, 250VAC); FUSE 2(3.15A, 250VAC)
- 2) LED 1 Keep light representative normal, if keep flash interval representative trouble Alarm
- 3) RV1, RV2, RV3 Varistor

PCB (1)

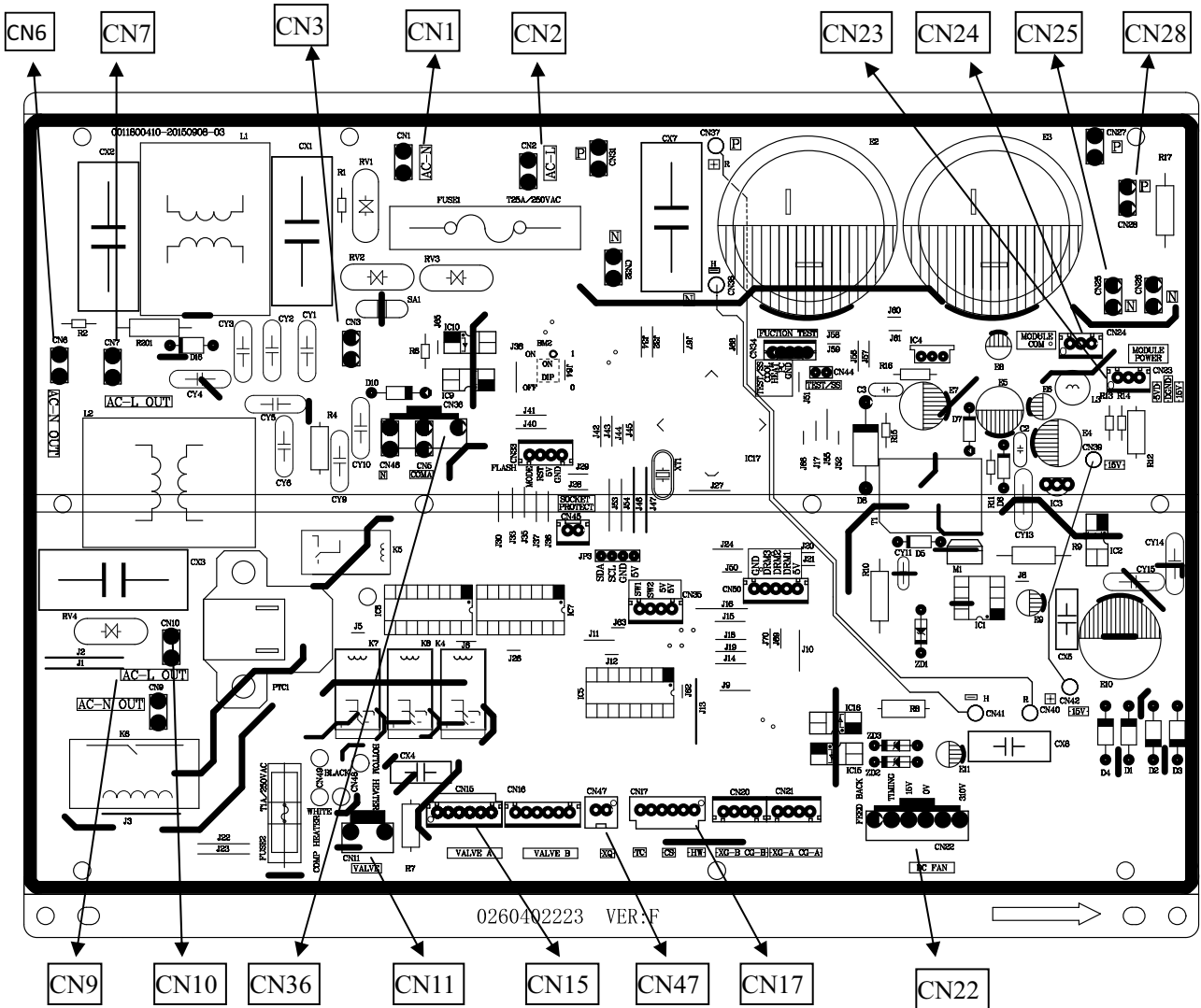

PCB(2)

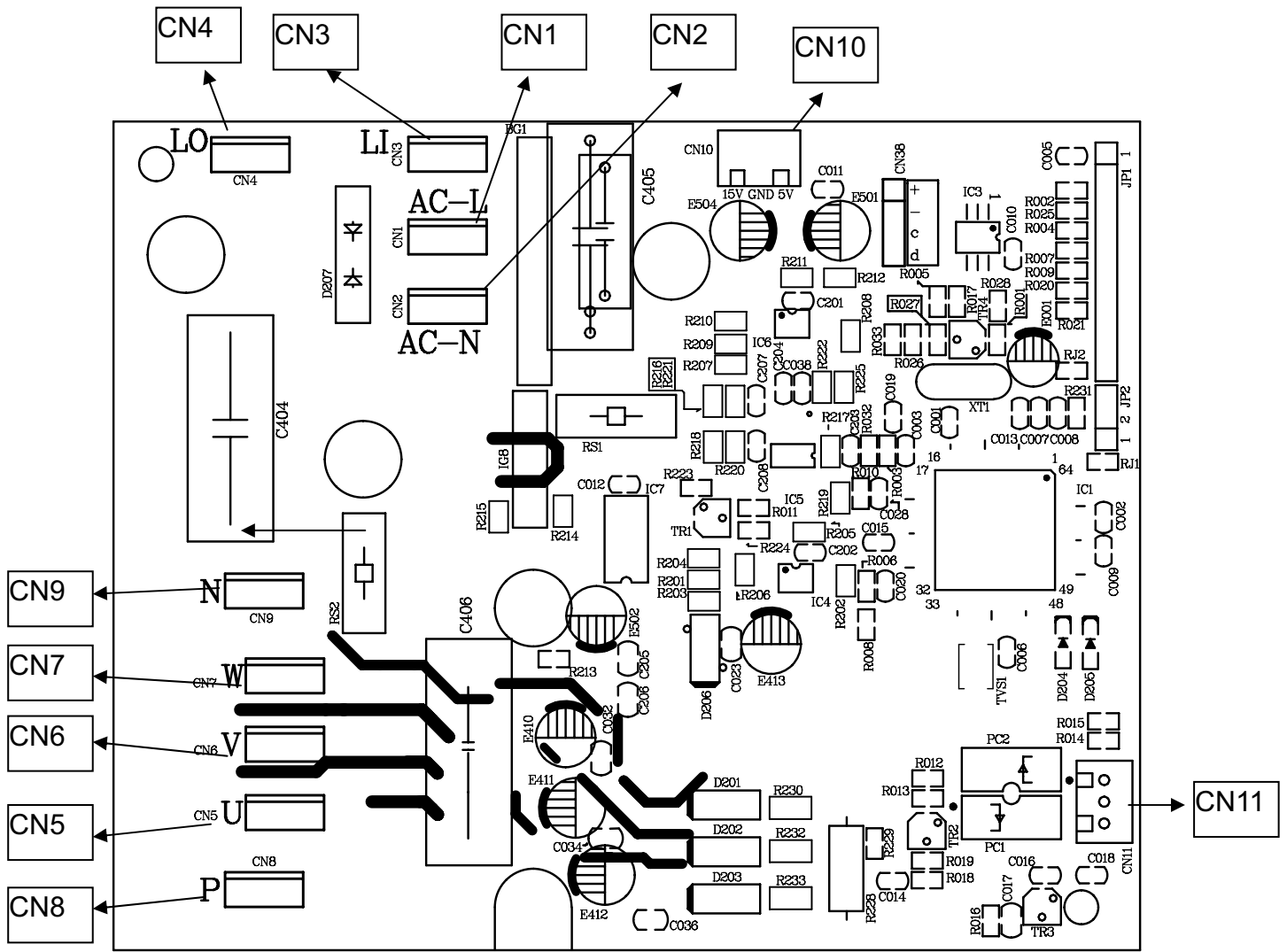

# Wiring diagrams

## INDOOR UNIT

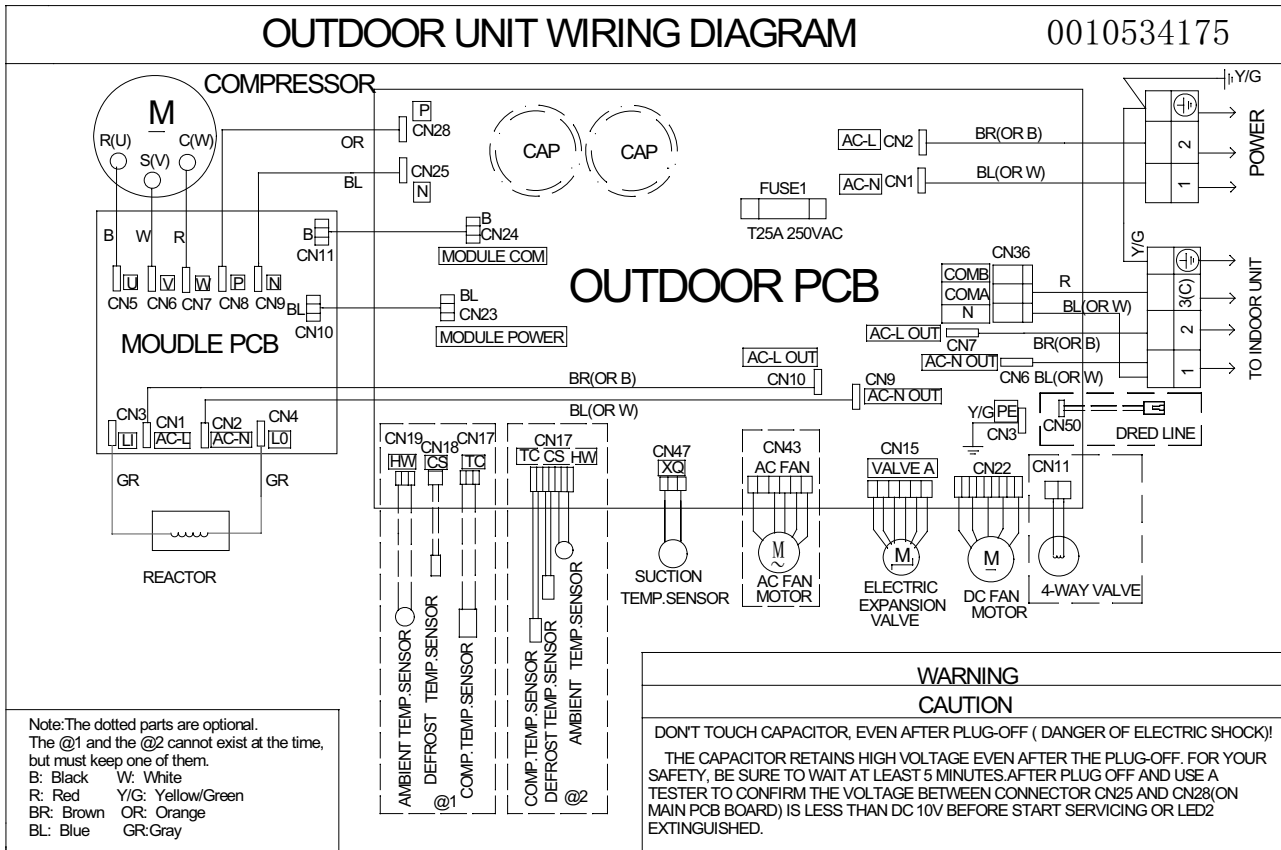



## 7. Functions and control

### 7.1 Main functions and control specification

#### 7.1.1 The operation frequency of outdoor unit and its control

##### 7.1.1.1 The operation frequency control of compressor

The operation frequency scope of compressor:

Mode	Minimum operation frequency	Maximum operation frequency
Heating (18K/24K)	24 Hz /20Hz	103 Hz /100Hz
Refrigeration (18K/24K)	20 Hz /20Hz	85 Hz /85Hz

##### 7.1.1.2 The starting of compressor

When the compressor is started for the first time, it must be kept under the conditions of 38Hz,58Hz,88Hz for 30second,one minute, one minute (the overheating protection of the outdoor unit air-blowing temperature, immediately decrease the frequency when the compressor is overflowing and releasing the pressure), then it can be operated towards the target frequency. When the machine runs normally, there's no such process. After starting the compressor for operation, the compressor should run according to the calculated frequency, and every determined frequency for protection should be prior to the calculated frequency.

##### 7.1.1.3 The speeds of increasing or decreasing the frequency of the compressor

The speed of increasing or decreasing the frequency rapidly 1 -----1HZ/second

The speed of increasing or decreasing the frequency slowly 2 -----1HZ/10seconds

##### 7.1.1.4 The calculation of the compressor's frequency

Refrigeration/dehumidification mode:

$$P_n = (N_h\_c - S\_c) * 10 \geq 50 \quad \text{outdoor environment control}$$

$$P_n = (N_h\_c - S\_c) * 10 < 50 \quad \text{PID control}$$

Heating mode:

$$P_n = (S\_c - N_h\_c) * 10 \geq 60 \quad \text{outdoor environment control}$$

$$P_n = (S\_c - N_h\_c) * 10 < 60 \quad \text{PID control}$$

( $N_h\_c$ =indoor environment temperature     $S\_c$ =setting temperature)

1) The minimum/maximum frequency limitation

A. While refrigerating: F-MAX-r is the maximum operation frequency of the compressor; F-MIN-r is the minimum operation frequency of the compressor.

B. While heating: F-MAX-d is the maximum operation frequency of the compressor; F-MIN-d is the minimum operation frequency of the compressor.

2) The frequency limitation which is affected by the environment temperature.

( $W_h\_c$ = environment temperature)

Heating mode:

Serial No.	Temperature scope	Frequency limitation (18K/24K)
1	$W_h\_c < -12$	Max_hz1 103HZ/87 HZ
2	$W_h\_c < -8$	Max_hz2 103HZ/87 HZ

3	Wh_c<-2	Max_hz3	103HZ/87 HZ
4	Wh_c<5	Max_hz4	90HZ/76 HZ
5	Wh_c<10	Max_hz5	78HZ/67 HZ
6	Wh_c<17	Max_hz6	67HZ/62 HZ
7	Wh_c<20	Max_hz7	56HZ/44 HZ
8	Wh_c>=20	Max_hz8	52HZ/39 HZ

Remarks: The above are the maximum frequency limitations of the complete appliance which are affected by the environment, and they have nothing to do with the ability of the indoor unit.

Refrigeration/dehumidification mode:

Serial No.	Temperature scope	Frequency limitation (18K/24K)	
1	Wh_c<16	Max_hz1	33HZ/30HZ
2	Wh_c<22	Max_hz2	43HZ/35 HZ
3	Wh_c<29	Max_hz3	55HZ/51 HZ
4	Wh_c<32	Max_hz4	63HZ/62 HZ
5	Wh_c<40	Max_hz5	75HZ/75 HZ
6	Wh_c<48	Max_hz6	63HZ/66 HZ
7	Wh_c>=48	Max_hz7	53HZ/49 HZ

Remarks: the above are not only the maximum frequency limitations of the complete appliance which are affected by the environment, but also the maximum ability limitation of the system. When the starting ability is not the maximum, its maximum frequency limitation is calculated by the following equations:

The frequency limitation which is affected by the temperature and under the condition of actual ability = the actual running system ability \* the maximum frequency which is limited by the temperature and under the condition of maximum ability / the maximum designing ability of the system

Refrigeration/dehumidification mode:

The indoor setting airflow speed	Low	Medium	Quiet
The percentage of the rated frequency K (18K/24K)	70%/700%	85%/85%	42%/60%

Heating mode:

The indoor setting airflow speed	Low	Medium	Quiet
The percentage of the rated frequency K (18K/24K)	80%/80%	90%/90%	51%/60%

The calculation of the actual output frequency:

$$F = F-ED - *(rated frequency) \times K$$

F-ED-\*(rated frequency) = The frequency which is limited by the outdoor environment temperature

Notes:

When refrigerating, it is needed to satisfy

$$F\text{-MIN-d}(\text{compressor's Min\_hz}) < F < F\text{-MAX-d}(\text{compressor's Max\_hz})$$

When heating, it is needed to satisfy

$$F\text{-MIN-r}(\text{compressor's Min\_hz}) < F < F\text{-MAX-r}(\text{compressor's Max\_hz})$$

PID control :

The initial frequency  $S_n$  is determined by  $P_n$ . We can calculate  $H_z\text{outf}$  according to the value of  $K_p, K_i, K_d, \text{Out\_gain}, P_n$ . Then,  $F_n = S_n + H_z\text{outf}$ . The value of  $F_n$  is calculated in each sample time (60 seconds), and  $F_n$  is adjusted according to previous frequency of  $S_n$  and filtered output of  $H_z\text{outf}$ .

### 7.1.2 The outdoor fan control (Exchange fan)

When the fan is changed among every airflow speed (including stop blowing), in order to avoid the airflow speed from skipping frequently, it must be kept under each mode for over 30 seconds, and then it can be changed to another mode (when refrigerating, the time is changed to 15 seconds).

#### 7.1.2.1 The outdoor fan control

Within three minutes of compressor starting, the compressor is controlled according to the ambient temperature.

Tao (°C)	Tao < 22°C	22°C < Tao < 28°C	Tao ≥ 29°C
Refrigeration/dehumidification (18K/24K)	2nd level / 2nd level	3rd level / 4th level	5th level / 6th level
Tao (°C)	Tao << 10°C	10°C < Tao < 17°C	Tao ≥ 17°C
Heating	5th level / 6th level	3th level / 5th level	3rd level / 2nd level

After 3 minutes, the compressor is controlled according to the ambient temperature and the frequency of the compressor.

Refrigeration/dehumidification frequency (Hz) 18K (24K)		< 40 Hz	40 Hz - 60 Hz	≥ 60 Hz
Tao (°C)	≤ 22	2nd level	3rd level	5th level (6th)
	22-28	3rd level	5th level	7th level (6th)
	≥ 28	7th level		

Heating frequency (Hz) (18K/24K)		< 51 Hz	51-70 Hz	≥ 70 Hz
Tao (°C)	≤ 10	5th level (3rd)	6th level	7th level
	10-17	3rd level (2nd)	4th level	5th level (6th)
	≥ 17	2nd level		

### 7.1.3 The control of the outdoor Electronic expansion valve (EEV)

In cooling mode, the EEV opening range is 90~480 steps. The EEV opening is 90 steps when unit is off.

In heating mode, the EEV opening range is 60~480 steps. The EEV opening is 60 steps when unit is off.

After outdoor unit is off, the EEV opening keep the current on for 5 s, then open the EEV completely for 2 minutes, then become 90 steps (cooling) or 60 steps (heating).

The EEV opening will increase if SH (superheat degree) >0 while decrease if SH<0.

Adjust frequency:

If |SH|=0, 60s/ 1 step

If |SH|≥3, and ΔSH=0, 10s/ 1 step.

If 3≥|SH|≥0, 30s/ 1 step.

ΔSH= current SH- last SH

SH= Ts (suction temp)-Tc1 (indoor coil temp)-Tsh (fixed data, depend on different models, -1~2)

### 7.1.4 Four way control

For the details of defrosting four-way valve control, see the defrosting process.

Four way working in other ways:

Under the mode of heating, open the four-way valve, when the compressor is not started or changed to non-heating mode, make sure the compressor is stopped for 2 minutes, and then close the four-way valve.

### 7.1.5 Protection function

#### 7.1.5.1 TTC high temperature-preventing protection

Once the machine is started, it can run TTC(air-blowing temp) overheating protection of air-blowing, but air-blowing sensor malfunction must alarm after 4 minutes during which the compressor is started (during the course of self-detection, there's no such limitation)

Sensor detection methods: 100 times (one cycle of procedure run is one time, and about 5ms, detection method for each time: continuously sampling for 8 times, then order them and take the mean value of the middle 2 values), take the mean value.

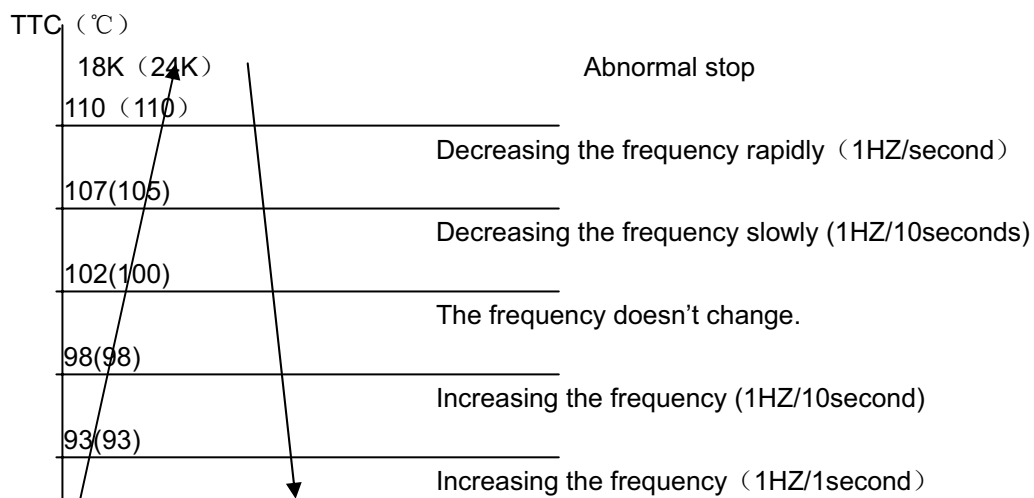

TTC≥110°C lasts for 20 seconds. Overheating protection of air-blowing, alarm malfunction to the indoor, others don't last.

#### 7.1.5.2 TC high temperature-preventing control of the indoor heating unit:

Tpg\_indoor is the highest value of the effective indoor unit (start it and it is in accord with the running state). TC=indoor coil temp.

The indoor heat exchanger sensor tests the temperature of the indoor heat exchanger. If the temperature is higher than 63°C, decrease the rotate speed of the compressor and do the high temperature-preventing protection of the indoor heat exchanger; if the temperature of the indoor heat exchanger is lower than 45°C, recover to the normal control.

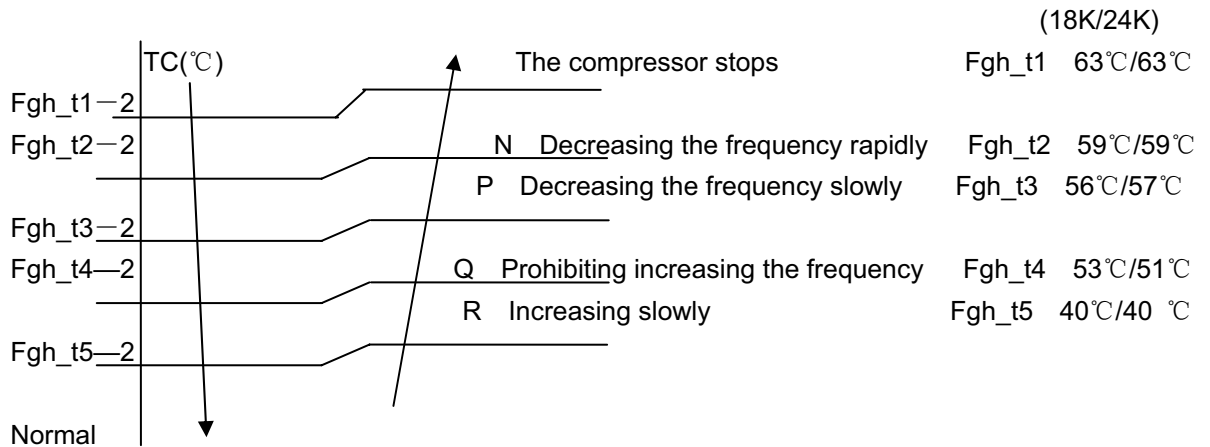

- N: Decreasing at the speed of 1HZ/1 second
- P: Decreasing at the speed of 1Hz/10 seconds
- Q: Continue to keep the last-time instruction cycle
- R: Increasing at the speed of 1Hz/10seconds

Remarks: the outdoor unit

### 7.1.5.3 The control of preventing the over current of the compressor:

- During the starting process of the compressor, if the current of the compressor is greater than 15.5A /17A(18K/24K)for 3 seconds, stop the compressor and alarm, after 3 minutes, start it again, if such state appears 3 times in 20 minutes, stop the compressor and alarm, and confirm the malfunction. Then continue to run it only after the power is off.
- During the starting process of the compressor, if the AC current is greater than 14.5A/15A(18K/24K), the frequency of the compressor decreases at the speed of 1HZ/second.
- During the starting process of the compressor, if the AC current is greater than 13.5A/14A(18K/24K), the frequency of the compressor decreases at the speed of 0.1HZ/second.
- During the starting process of the compressor, if the AC current is greater than 13A/13A(18K/24K), the frequency of the compressor increases at the prohibited speed.
- During the starting process of the compressor, if the AC current is greater than 11.5A/12A(18K/24K) the frequency of the compressor increases at the speed of no faster than 0.1HZ/second.

### 7.1.5.4 The protection function of AC current:

During the starting process of the compressor, if the AC current is greater than 15.5A/17.5A(18K/24K) for 3 seconds, stop the compressor and alarm, after 3 minutes, start it again, if such state appears 3 times in 20 minutes, stop the compressor and alarm, and confirm the malfunction. Then continue to run it only after the the power is off.

During the starting process of the compressor, if the AC current is greater than 14.5A 15A(18K/24K), the frequency of the compressor decreases at the speed of 1HZ/second.

During the starting process of the compressor, if the AC current is greater than 13.5/14A(18K/24K), the frequency of the compressor decreases at the speed of 0.1HZ/second.

During the starting process of the compressor, if the AC current is greater than 13A/13A(18K/24K), the frequency of the compressor increases at the prohibited speed.

During the starting process of the compressor, if the AC current is greater than 11.5A/12A(18K/24K), the frequency of the compressor increases at the speed of no faster than 0.1HZ/second.

Remarks: when the outdoor temperature is high, there's compensation for AC current protection.

(1) When the outdoor environment temperature is higher than 40°C, AC current protection value decreases by 2.5A/1A(18K/24K).

(2) When the outdoor environment temperature is higher than 50°C, AC current protection value decreases by 3.5A/2A(18K/24K).

### 7.1.5.5 Anti-freezing protection of the indoor heat exchanger

When refrigerating/heating, prevent freezing.

Tpg\_indoor is the minimum value of the effective indoor unit (start it and it is in accord with the running state).

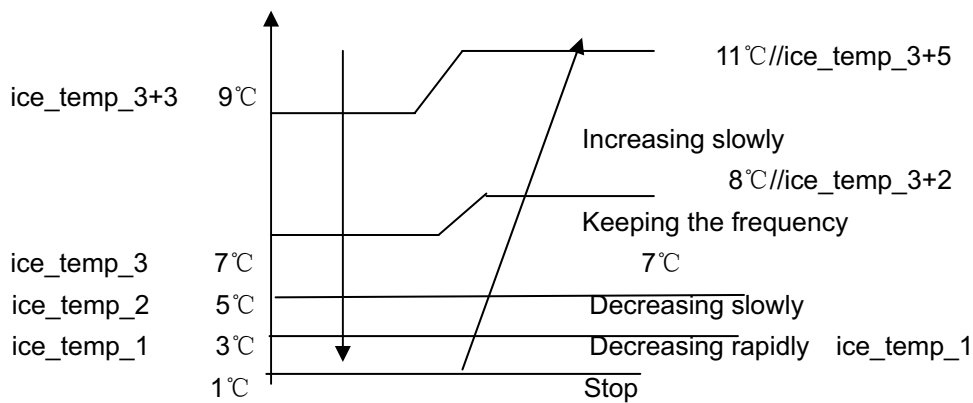

When  $Tpg\_indoor < ice\_temp\_1$ , the frequency of the compressor decreases at the speed of 1HZ/1second.

When  $Tpg\_indoor < ice\_temp\_2$ , the frequency of the compressor decreases at the speed of 1HZ/10seconds.

When  $Tpg\_indoor$  begins to rise again, and  $ice\_temp\_2 \leq Tpg\_indoor \leq ice\_temp\_3$ , the frequency of the compressor doesn't change.

When  $ice\_temp\_3 < Tpg\_indoor < ice\_temp\_3+3^\circ C$ , the frequency of the compressor increases at the speed of 1HZ/10seconds.

For example,  $Tpg\_indoor \leq 0^\circ C$ , last for 2 minutes, and then the outdoor unit will stop, and report underload malfunction, but don't send malfunction report to the indoor.

The compressor stops for more than 3 minutes,  $Tpg\_indoor > ice\_temp\_3+2^\circ C$ , the compressor recovers.

### 7.1.5.6 The frequency limitation of modification rate

In the field which is controlled by high frequency, if the modification rate is not high enough, the

control-driven chip will enter into weak magnetic control, this will help to relieve the problem of modification rate. If during the course of weak magnetic control, the modification rate is still not high enough, enter into the control of decreasing frequency until the alarm of modification rate is relieved.

7.1.5.7 Temperature protection of the outdoor refrigerating coil

When the frequency are higher than 40Hz,and the defrosting sensor's temperature are higher than 68°C, the frequency of the compressor decreases 1hz/10seconds. Keep the frequency until it decreases to the lowest frequency. When the temperatures are lower than 68°C and higher than 62°C, keep the frequency of the compressor. When the temperatures are lower than 62°C, relieve the defrosting temperature protection.

7.2 Value of Thermistor

Ambient Sensor, Defrosting Sensor, Pipe sensor

R25°C=10KΩ ± 3% B25°C/50°C=3700K ± 3%

Temp.(°C)	Max.(KΩ)	Normal(KΩ)	Min.(KΩ)	Tolerance(°C)	
-30	165.2170	147.9497	132.3678	-1.94	1.75
-29	155.5754	139.5600	125.0806	-1.93	1.74
-28	146.5609	131.7022	118.2434	-1.91	1.73
-27	138.1285	124.3392	111.8256	-1.89	1.71
-26	130.2371	117.4366	105.7989	-1.87	1.70
-25	122.8484	110.9627	100.1367	-1.85	1.69
-24	115.9272	104.8882	94.8149	-1.83	1.67
-23	109.4410	99.1858	89.8106	-1.81	1.66
-22	103.3598	93.8305	85.1031	-1.80	1.64
-21	97.6556	88.7989	80.6728	-1.78	1.63
-20	92.3028	84.0695	76.5017	-1.76	1.62
-19	87.2775	79.6222	72.5729	-1.74	1.60
-18	82.5577	75.4384	68.8710	-1.72	1.59
-17	78.1230	71.5010	65.3815	-1.70	1.57
-16	73.9543	67.7939	62.0907	-1.68	1.55
-15	70.0342	64.3023	58.9863	-1.66	1.54
-14	66.3463	61.0123	56.0565	-1.64	1.52
-13	62.8755	57.9110	53.2905	-1.62	1.51
-12	59.6076	54.9866	50.6781	-1.60	1.49
-11	56.5296	52.2278	48.2099	-1.58	1.47
-10	53.6294	49.6244	45.8771	-1.56	1.46
-9	50.8956	47.1666	43.6714	-1.54	1.44
-8	48.3178	44.8454	41.5851	-1.51	1.42
-7	45.8860	42.6525	39.6112	-1.49	1.40
-6	43.5912	40.5800	37.7429	-1.47	1.39
-5	41.4249	38.6207	35.9739	-1.45	1.37
-4	39.3792	36.7676	34.2983	-1.43	1.35
-3	37.4465	35.0144	32.7108	-1.41	1.33

-2	35.6202	33.3552	31.2062	-1.38	1.31
-1	33.8936	31.7844	29.7796	-1.36	1.29
0	32.2608	30.2968	28.4267	-1.34	1.28
1	30.7162	28.8875	27.1431	-1.32	1.26
2	29.2545	27.5519	25.9250	-1.29	1.24
3	27.8708	26.2858	24.7686	-1.27	1.22
4	26.5605	25.0851	23.6704	-1.25	1.20
5	25.3193	23.9462	22.6273	-1.23	1.18
6	24.1432	22.8656	21.6361	-1.20	1.16
7	23.0284	21.8398	20.6939	-1.18	1.14
8	21.9714	20.8659	19.7982	-1.15	1.12
9	20.9688	19.9409	18.9463	-1.13	1.09
10	20.0176	19.0621	18.1358	-1.11	1.07
11	19.1149	18.2270	17.3646	-1.08	1.05
12	18.2580	17.4331	16.6305	-1.06	1.03
13	17.4442	16.6782	15.9315	-1.03	1.01
14	16.6711	15.9601	15.2657	-1.01	0.99
15	15.9366	15.2770	14.6315	-0.98	0.96
16	15.2385	14.6268	14.0271	-0.96	0.94
17	14.5748	14.0079	13.4510	-0.93	0.92
18	13.9436	13.4185	12.9017	-0.91	0.90
19	13.3431	12.8572	12.3778	-0.88	0.87
20	12.7718	12.3223	11.8780	-0.86	0.85
21	12.2280	11.8126	11.4011	-0.83	0.83
22	11.7102	11.3267	10.9459	-0.81	0.80
23	11.2172	10.8634	10.5114	-0.78	0.78
24	10.7475	10.4216	10.0964	-0.75	0.75
25	10.3000	10.0000	9.7000	-0.75	0.75
26	9.8975	9.5974	9.2980	-0.76	0.76
27	9.5129	9.2132	8.9148	-0.80	0.80
28	9.1454	8.8465	8.5496	-0.84	0.83
29	8.7942	8.4964	8.2013	-0.87	0.86
30	8.4583	8.1621	7.8691	-0.91	0.90
31	8.1371	7.8428	7.5522	-0.95	0.93
32	7.8299	7.5377	7.2498	-0.98	0.97
33	7.5359	7.2461	6.9611	-1.02	1.00
34	7.2546	6.9673	6.6854	-1.06	1.04
35	6.9852	6.7008	6.4222	-1.10	1.07
36	6.7273	6.4459	6.1707	-1.13	1.11
37	6.4803	6.2021	5.9304	-1.17	1.14
38	6.2437	5.9687	5.7007	-1.21	1.18
39	6.0170	5.7454	5.4812	-1.25	1.22
40	5.7997	5.5316	5.2712	-1.29	1.25



41	5.5914	5.3269	5.0704	-1.33	1.29
42	5.3916	5.1308	4.8783	-1.37	1.33
43	5.2001	4.9430	4.6944	-1.41	1.36
44	5.0163	4.7630	4.5185	-1.45	1.40
45	4.8400	4.5905	4.3500	-1.49	1.44
46	4.6708	4.4252	4.1887	-1.53	1.47
47	4.5083	4.2666	4.0342	-1.57	1.51
48	4.3524	4.1145	3.8862	-1.61	1.55
49	4.2026	3.9686	3.7443	-1.65	1.59
50	4.0588	3.8287	3.6084	-1.70	1.62
51	3.9206	3.6943	3.4780	-1.74	1.66
52	3.7878	3.5654	3.3531	-1.78	1.70
53	3.6601	3.4416	3.2332	-1.82	1.74
54	3.5374	3.3227	3.1183	-1.87	1.78
55	3.4195	3.2085	3.0079	-1.91	1.82
56	3.3060	3.0989	2.9021	-1.95	1.85
57	3.1969	2.9935	2.8005	-2.00	1.89
58	3.0919	2.8922	2.7029	-2.04	1.93
59	2.9909	2.7948	2.6092	-2.08	1.97
60	2.8936	2.7012	2.5193	-2.13	2.01
61	2.8000	2.6112	2.4328	-2.17	2.05
62	2.7099	2.5246	2.3498	-2.22	2.09
63	2.6232	2.4413	2.2700	-2.26	2.13
64	2.5396	2.3611	2.1932	-2.31	2.17
65	2.4591	2.2840	2.1195	-2.36	2.21
66	2.3815	2.2098	2.0486	-2.40	2.25
67	2.3068	2.1383	1.9803	-2.45	2.29
68	2.2347	2.0695	1.9147	-2.49	2.34
69	2.1652	2.0032	1.8516	-2.54	2.38
70	2.0983	1.9393	1.7908	-2.59	2.42
71	2.0337	1.8778	1.7324	-2.63	2.46
72	1.9714	1.8186	1.6761	-2.68	2.50
73	1.9113	1.7614	1.6219	-2.73	2.54
74	1.8533	1.7064	1.5697	-2.78	2.58
75	1.7974	1.6533	1.5194	-2.83	2.63
76	1.7434	1.6021	1.4710	-2.88	2.67
77	1.6913	1.5528	1.4243	-2.92	2.71
78	1.6409	1.5051	1.3794	-2.97	2.75
79	1.5923	1.4592	1.3360	-3.02	2.80
80	1.5454	1.4149	1.2942	-3.07	2.84
81	1.5000	1.3721	1.2540	-3.12	2.88
82	1.4562	1.3308	1.2151	-3.17	2.93
83	1.4139	1.2910	1.1776	-3.22	2.97

84	1.3730	1.2525	1.1415	-3.27	3.01
85	1.3335	1.2153	1.1066	-3.32	3.06
86	1.2953	1.1794	1.0730	-3.38	3.10
87	1.2583	1.1448	1.0405	-3.43	3.15
88	1.2226	1.1113	1.0092	-3.48	3.19
89	1.1880	1.0789	0.9789	-3.53	3.24
90	1.1546	1.0476	0.9497	-3.58	3.28
91	1.1223	1.0174	0.9215	-3.64	3.33
92	1.0910	0.9882	0.8942	-3.69	3.37
93	1.0607	0.9599	0.8679	-3.74	3.42
94	1.0314	0.9326	0.8424	-3.80	3.46
95	1.0030	0.9061	0.8179	-3.85	3.51
96	0.9756	0.8806	0.7941	-3.90	3.55
97	0.9490	0.8558	0.7711	-3.96	3.60
98	0.9232	0.8319	0.7489	-4.01	3.64
99	0.8983	0.8088	0.7275	-4.07	3.69
100	0.8741	0.7863	0.7067	-4.12	3.74
101	0.8507	0.7646	0.6867	-4.18	3.78
102	0.8281	0.7436	0.6672	-4.23	3.83
103	0.8061	0.7233	0.6484	-4.29	3.88
104	0.7848	0.7036	0.6303	-4.34	3.92
105	0.7641	0.6845	0.6127	-4.40	3.97
106	0.7441	0.6661	0.5957	-4.46	4.02
107	0.7247	0.6482	0.5792	-4.51	4.07
108	0.7059	0.6308	0.5632	-4.57	4.12
109	0.6877	0.6140	0.5478	-4.63	4.16
110	0.6700	0.5977	0.5328	-4.69	4.21
111	0.6528	0.5820	0.5183	-4.74	4.26
112	0.6361	0.5667	0.5043	-4.80	4.31
113	0.6200	0.5518	0.4907	-4.86	4.36
114	0.6043	0.5374	0.4775	-4.92	4.41
115	0.5891	0.5235	0.4648	-4.98	4.45
116	0.5743	0.5100	0.4524	-5.04	4.50
117	0.5600	0.4968	0.4404	-5.10	4.55
118	0.5460	0.4841	0.4288	-5.16	4.60
119	0.5325	0.4717	0.4175	-5.22	4.65
120	0.5194	0.4597	0.4066	-5.28	4.70

### Discharging Sensor

R80°C=50KΩ ± 3%

B25/80°C=4450K±3%

Temp.(°C)	Max.(KΩ)	Normal(KΩ)	Min.(KΩ)	Tolerance(°C)	
-30	14646.0505	12061.7438	9924.4999	-2.96	2.45

-29	13654.1707	11267.8730	9290.2526	-2.95	2.44
-28	12735.8378	10531.3695	8700.6388	-2.93	2.44
-27	11885.1336	9847.7240	8152.2338	-2.92	2.43
-26	11096.6531	9212.8101	7641.8972	-2.91	2.42
-25	10365.4565	8622.8491	7166.7474	-2.90	2.42
-24	9687.0270	8074.3787	6724.1389	-2.88	2.41
-23	9057.2314	7564.2244	6311.6413	-2.87	2.41
-22	8472.2852	7089.4741	5927.0206	-2.86	2.40
-21	7928.7217	6647.4547	5568.2222	-2.84	2.39
-20	7423.3626	6235.7109	5233.3554	-2.83	2.39
-19	6953.2930	5851.9864	4920.6791	-2.82	2.38
-18	6515.8375	5494.2064	4628.5894	-2.80	2.37
-17	6108.5393	5160.4621	4355.6078	-2.79	2.37
-16	5729.1413	4848.9963	4100.3708	-2.77	2.36
-15	5375.5683	4558.1906	3861.6201	-2.76	2.35
-14	5045.9114	4286.5535	3638.1938	-2.75	2.34
-13	4738.4141	4032.7098	3429.0191	-2.73	2.34
-12	4451.4586	3795.3910	3233.1039	-2.72	2.33
-11	4183.5548	3573.4260	3049.5312	-2.70	2.32
-10	3933.3289	3365.7336	2877.4527	-2.69	2.31
-9	3699.5139	3171.3148	2716.0828	-2.67	2.30
-8	3480.9407	2989.2460	2564.6945	-2.66	2.29
-7	3276.5302	2818.6731	2422.6139	-2.64	2.28
-6	3085.2854	2658.8058	2289.2164	-2.63	2.28
-5	2906.2851	2508.9126	2163.9230	-2.61	2.27
-4	2738.6777	2368.3158	2046.1961	-2.60	2.26
-3	2581.6752	2236.3876	1935.5371	-2.58	2.25
-2	2434.5487	2112.5459	1831.4826	-2.56	2.24
-1	2296.6230	1996.2509	1733.6024	-2.55	2.23
0	2167.2730	1887.0018	1641.4966	-2.53	2.22
1	2045.9191	1784.3336	1554.7931	-2.52	2.21
2	1932.0242	1687.8144	1473.1460	-2.50	2.20
3	1825.0899	1597.0431	1396.2333	-2.48	2.19
4	1724.6540	1511.6468	1323.7551	-2.47	2.17
5	1630.2870	1431.2787	1255.4324	-2.45	2.16
6	1541.5904	1355.6163	1191.0048	-2.43	2.15
7	1458.1938	1284.3593	1130.2298	-2.41	2.14
8	1379.7528	1217.2282	1072.8813	-2.40	2.13
9	1305.9472	1153.9626	1018.7481	-2.38	2.12
10	1236.4792	1094.3200	967.6334	-2.36	2.11
11	1171.0715	1038.0743	919.3533	-2.35	2.09
12	1109.4661	985.0146	873.7359	-2.33	2.08
13	1051.4226	934.9440	830.6210	-2.31	2.07

14	996.7169	887.6792	789.8583	-2.29	2.06
15	945.1404	843.0486	751.3077	-2.27	2.04
16	896.4981	800.8922	714.8380	-2.26	2.03
17	850.6086	761.0603	680.3265	-2.24	2.02
18	807.3024	723.4134	647.6580	-2.22	2.00
19	766.4212	687.8205	616.7252	-2.20	1.99
20	727.8172	654.1596	587.4271	-2.18	1.98
21	691.3524	622.3161	559.6694	-2.16	1.96
22	656.8979	592.1831	533.3634	-2.14	1.95
23	624.3328	563.6604	508.4261	-2.12	1.93
24	593.5446	536.6540	484.7796	-2.10	1.92
25	564.4275	511.0760	462.3510	-2.09	1.90
26	536.9865	486.9352	441.1516	-2.07	1.89
27	511.0105	464.0500	421.0258	-2.05	1.87
28	486.4151	442.3499	401.9146	-2.03	1.86
29	463.1208	421.7683	383.7626	-2.01	1.84
30	441.0535	402.2430	366.5175	-1.99	1.83
31	420.1431	383.7151	350.1301	-1.97	1.81
32	400.3242	366.1295	334.5542	-1.95	1.80
33	381.5350	349.4341	319.7460	-1.93	1.78
34	363.7176	333.5801	305.6645	-1.90	1.76
35	346.8176	318.5216	292.2709	-1.88	1.75
36	330.7839	304.2151	279.5286	-1.86	1.73
37	315.5682	290.6199	267.4031	-1.84	1.71
38	301.1254	277.6976	255.8620	-1.82	1.70
39	287.4128	265.4119	244.8745	-1.80	1.68
40	274.3905	253.7288	234.4118	-1.78	1.66
41	262.0206	242.6161	224.4465	-1.76	1.64
42	250.2676	232.0436	214.9529	-1.74	1.63
43	239.0983	221.9825	205.9065	-1.71	1.61
44	228.4809	212.4060	197.2844	-1.69	1.59
45	218.3860	203.2887	189.0648	-1.67	1.57
46	208.7855	194.6066	181.2273	-1.65	1.55
47	199.6531	186.3369	173.7524	-1.63	1.54
48	190.9639	178.4584	166.6217	-1.60	1.52
49	182.6945	170.9508	159.8181	-1.58	1.50
50	174.8228	163.7951	153.3249	-1.56	1.48
51	167.3280	156.9733	147.1268	-1.53	1.46
52	160.1904	150.4683	141.2090	-1.51	1.44
53	153.3914	144.2641	135.5577	-1.49	1.42
54	146.9136	138.3454	130.1598	-1.47	1.40
55	140.7403	132.6980	125.0027	-1.44	1.38
56	134.8559	127.3081	120.0746	-1.42	1.36

57	129.2457	122.1630	115.3645	-1.40	1.34
58	123.8956	117.2504	110.8618	-1.37	1.32
59	118.7926	112.5589	106.5564	-1.35	1.30
60	113.9241	108.0776	102.4388	-1.32	1.28
61	109.2784	103.7961	98.5000	-1.30	1.26
62	104.8443	99.7046	94.7315	-1.28	1.23
63	100.6112	95.7939	91.1253	-1.25	1.21
64	96.5692	92.0553	87.6735	-1.23	1.19
65	92.7088	88.4805	84.3690	-1.20	1.17
66	89.0211	85.0614	81.2048	-1.18	1.15
67	85.4976	81.7908	78.1744	-1.15	1.12
68	82.1303	78.6615	75.2715	-1.13	1.10
69	78.9116	75.6668	72.4902	-1.10	1.08
70	75.8343	72.8004	69.8249	-1.08	1.06
71	72.8916	70.0561	67.2703	-1.05	1.03
72	70.0770	67.4283	64.8213	-1.03	1.01
73	67.3844	64.9115	62.4731	-1.00	0.99
74	64.8080	62.5006	60.2211	-0.98	0.96
75	62.3423	60.1906	58.0609	-0.95	0.94
76	59.9821	57.9770	55.9885	-0.92	0.92
77	57.7223	55.8552	53.9998	-0.90	0.89
78	55.5583	53.8210	52.0912	-0.87	0.87
79	53.4856	51.8706	50.2591	-0.85	0.84
80	51.5000	50.0000	48.5000	-0.85	0.84
81	49.7063	48.2057	46.7083	-0.85	0.85
82	47.9835	46.4842	44.9911	-0.89	0.89
83	46.3286	44.8323	43.3452	-0.93	0.92
84	44.7385	43.2468	41.7672	-0.96	0.95
85	43.2105	41.7248	40.2540	-1.00	0.99
86	41.7386	40.2604	38.7996	-1.03	1.02
87	40.3241	38.8545	37.4048	-1.07	1.06
88	38.9643	37.5045	36.0668	-1.11	1.09
89	37.6569	36.2078	34.7831	-1.14	1.13
90	36.3996	34.9622	33.5513	-1.18	1.16
91	35.1903	33.7653	32.3689	-1.22	1.19
92	34.0269	32.6151	31.2338	-1.26	1.23
93	32.9075	31.5096	30.1438	-1.30	1.27
94	31.8302	30.4467	29.0970	-1.33	1.30
95	30.7933	29.4246	28.0915	-1.37	1.34
96	29.7950	28.4417	27.1254	-1.41	1.37
97	28.8337	27.4961	26.1970	-1.45	1.41
98	27.9078	26.5864	25.3048	-1.49	1.44
99	27.0160	25.7110	24.4470	-1.53	1.48

100	26.1569	24.8685	23.6222	-1.57	1.52
101	25.3290	24.0574	22.8291	-1.61	1.55
102	24.5311	23.2765	22.0662	-1.65	1.59
103	23.7620	22.5245	21.3323	-1.69	1.63
104	23.0205	21.8002	20.6261	-1.73	1.66
105	22.3055	21.1025	19.9465	-1.77	1.70
106	21.6159	20.4303	19.2924	-1.81	1.74
107	20.9508	19.7825	18.6626	-1.85	1.77
108	20.3091	19.1582	18.0563	-1.89	1.81
109	19.6899	18.5564	17.4723	-1.93	1.85
110	19.0924	17.9761	16.9098	-1.98	1.89
111	18.5157	17.4166	16.3680	-2.02	1.93
112	17.9590	16.8769	15.8458	-2.06	1.96
113	17.4214	16.3564	15.3427	-2.10	2.00
114	16.9023	15.8542	14.8577	-2.15	2.04
115	16.4010	15.3696	14.3902	-2.19	2.08
116	15.9167	14.9020	13.9394	-2.23	2.12
117	15.4489	14.4506	13.5047	-2.27	2.16
118	14.9968	14.0149	13.0855	-2.32	2.19
119	14.5599	13.5942	12.6811	-2.36	2.23
120	14.1376	13.1879	12.2909	-2.41	2.27
121	13.7294	12.7955	11.9144	-2.45	2.31
122	13.3347	12.4165	11.5510	-2.50	2.35
123	12.9531	12.0503	11.2003	-2.54	2.39
124	12.5840	11.6965	10.8617	-2.58	2.43
125	12.2270	11.3545	10.5348	-2.63	2.47
126	11.8817	11.0240	10.2191	-2.68	2.51
127	11.5475	10.7046	9.9142	-2.72	2.55
128	11.2242	10.3957	9.6197	-2.77	2.59
129	10.9112	10.0970	9.3352	-2.81	2.63
130	10.6084	9.8082	9.0602	-2.86	2.67
131	10.3151	9.5288	8.7945	-2.91	2.71
132	10.0312	9.2586	8.5378	-2.95	2.75
133	9.7563	8.9971	8.2895	-3.00	2.80
134	9.4901	8.7441	8.0495	-3.05	2.84
135	9.2322	8.4993	7.8175	-3.09	2.88
136	8.9824	8.2623	7.5931	-3.14	2.92
137	8.7404	8.0329	7.3760	-3.19	2.96
138	8.5059	7.8108	7.1660	-3.24	3.00
139	8.2787	7.5958	6.9629	-3.29	3.04
140	8.0584	7.3875	6.7664	-3.33	3.09

### 8. Dimensional drawings

unit:mm

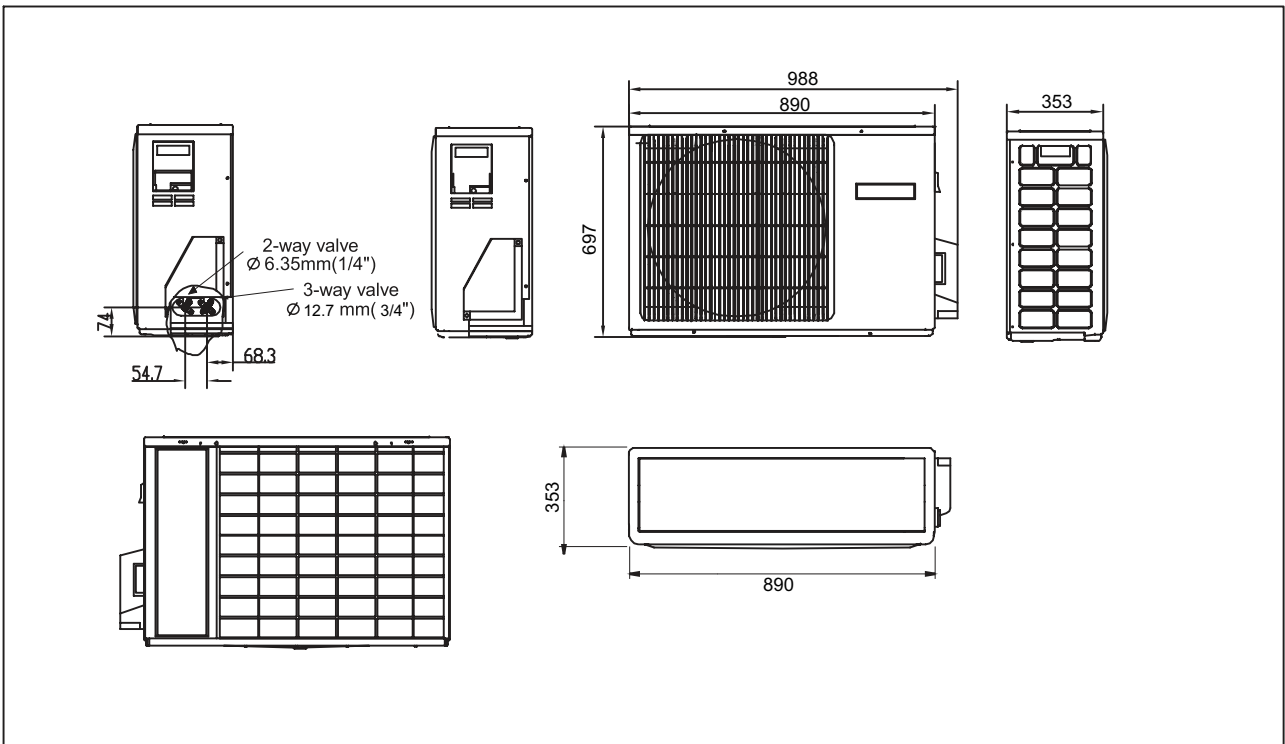

### 9. Center of gravity

unit:mm

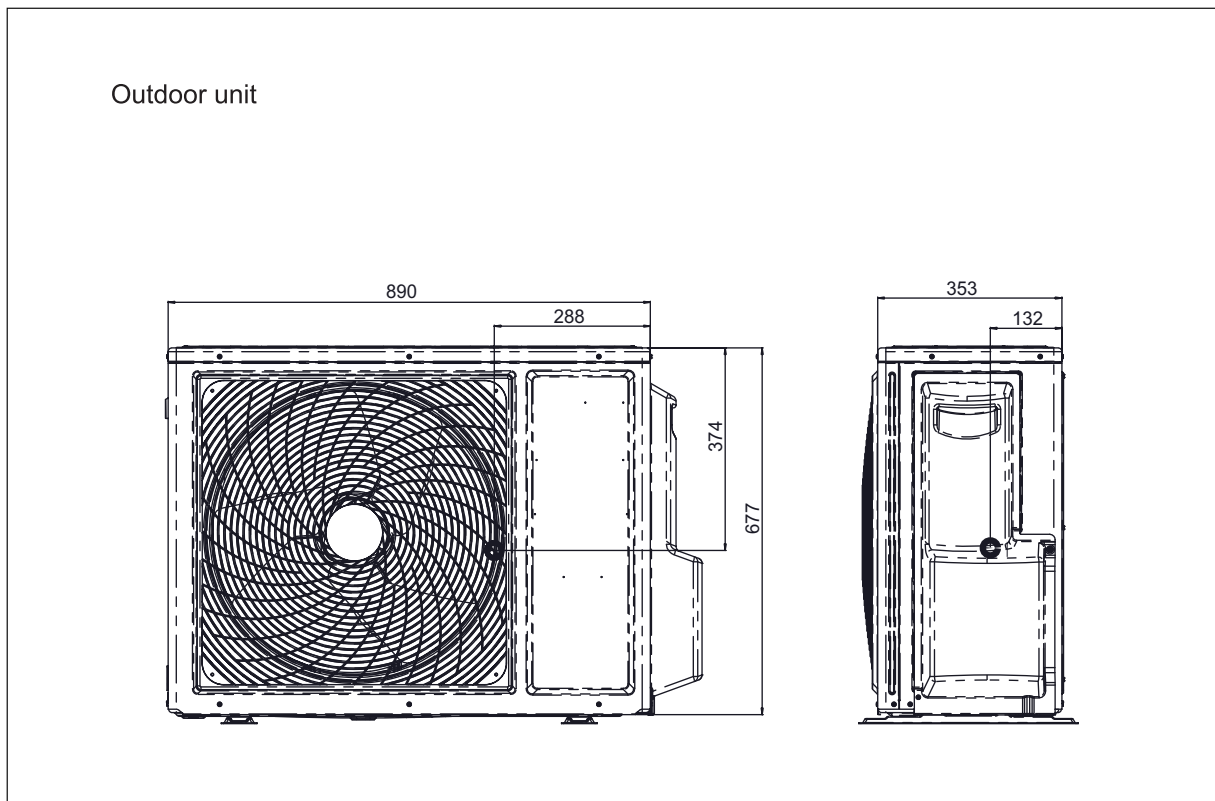

## 10 Service Diagnosis

### 10.1 Caution for Diagnosis

The operation lamp flashes when any of the following errors is detected.

1. When a protection device of the indoor or outdoor unit is activated or when the thermistor malfunctions, disabling equipment operation.
2. When a signal transmission error occurs between the indoor and outdoor units. In either case, conduct the diagnostic procedure described in the following pages.

#### Parameter of primary electronic appliance

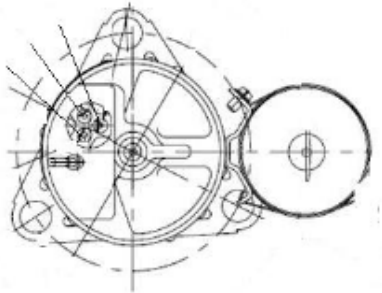
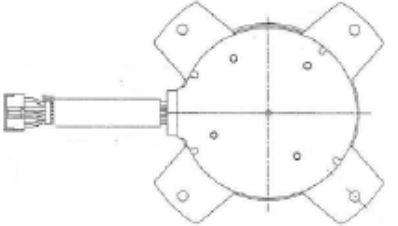
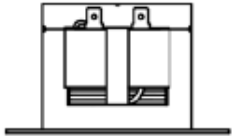
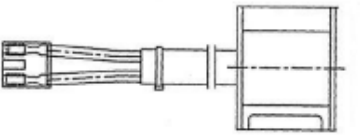
name	parameter	picture
Compressor	Rated voltage:220-230V Rated current:4.8A Rated frequency: 50/60HZ	
Fan motor	Rated voltage:220-230V Rated current:0.2A Rated frequency: 50/60HZ	
Reactor	Rated voltage:220-230V Rated current:10.5A Rated frequency: 50/60HZ	
4-way valve	Rated voltage:220-230V Rated current:0.1A Rated frequency: 50/60HZ	



## 10.2 Problem Symptoms and Measures

Symptom	Check Item	Details of Measure
None of the units operates	Check the power supply.	Check to make sure that the rated voltage is supplied.
	Check the indoor PCB	Check to make sure that the indoor PCB is broken
Operation sometimes stops.	Check the power supply.	A power failure of 2 to 10 cycles can stop air conditioner operation.
Equipment operates but does not cool, or does not heat (only for heat pump)	Check for faulty operation of the electronic expansion valve.	Set the units to cooling operation, and compare the temperatures of the liquid side connection pipes of the connection section among rooms to check the opening and closing operation of the electronic expansion valves of the individual units.
	Diagnosis by service port pressure and operating current.	Check for insufficient gas.
Large operating noise and vibrations	Check the installation condition.	Check to make sure that the required spaces for installation (specified in the Technical Guide, etc.) are provided.

## 10.3 Error Codes and Description indoor display

	Code indication			fault description	Reference Page
	Indoor displaying panel code indication		Outdoor (LED1 flash times)		
	Other display	Only For 498 and 498A display (Red/Green Time Run □On ★Flash ■Off ,)			
Indoor and Outdoor	E7	■ ■ ★	15	Communication fault between indoor and outdoor units	Page .43
Indoor Malfunction	E1	★ ■ ■	--	Room temperature sensor failure	Page 33
	E2	★ □ □	--	Heat-exchange sensor failure	Page 33
	E4	★ □ ★	--	Indoor EEPROM error	Page 34.
	E9	★ ★ ★	21	High-work intense protection	Page 46
	E14	■ □ ★	--	Indoor fan motor malfunction	Page 35
Outdoor Malfunction	F12	■ ★ ■	1	Outdoor EEPROM error	Page .34
	F1	□ ★ ★	2	The protection of IPM	Page .38
	F22	★ ★ ■	3	Overcurrent protection of AC electricity for the outdoor model	Page .39
	F3	■ ★ ■	4	Communication fault between the IPM and outdoor PCB	Page.40
	F19	■ ★ □	6	Power voltage is too high or low	Page .41
	F4	■ ★ ■	8	Overheat protection for Discharge temperature	Page .42
	F21	□ □ ★	10	Defrost temperature sensor failure	Page 33
	F7	■ ★ ■	11	Suction temperature sensor failure	Page.33
	F6	□ ★ ■	12	Ambient temperature sensor failure	Page 33
	F25	★ □ ■	13	Discharge temperature sensor failure	Page 33
	F11	■ ★ ■	18	deviate from the normal for the compressor	Page .45
	F28	■ ★ ■	19	Loop of the station detect error	Page .45
	F2	■ ★ □	24	Overcurrent of the compressor	Page .39
	F8	■ ★ □	9	Outdoor DC fan motor fault	Page 36
	F23	■ ★ □	25	Overcurrent protection for single-phase of the compressor	Page .39

### 10.3.1 Thermistor or Related Abnormality

- Indoor Display    ★ ■ ■ / E1: Room temperature sensor failure
- ★ □ □ / E2: Heat-exchange sensor failure
- Outdoor display    LED1 flash 10 times: Defrost temperature sensor failure
- LED1 flash 11 times: Suction temperature sensor failure
- LED1 flash 12 times: Ambient temperature sensor failure
- LED1 flash 13 times: Discharge temperature sensor failure

Method of Malfunction Detection

The temperatures detected by the thermistors are used to determine thermistor errors

Malfunction Decision Conditions

When the thermistor input is more than 4.92V or less than 0.08V during compressor operation.

- Note: The values vary slightly in some models

Supposed Causes

- Faulty connector connection
- Faulty thermistor
- Faulty PCB

Troubleshooting

\* Caution Be sure to turn off power switch before connect or disconnect connector, or else parts damage may be occurred.

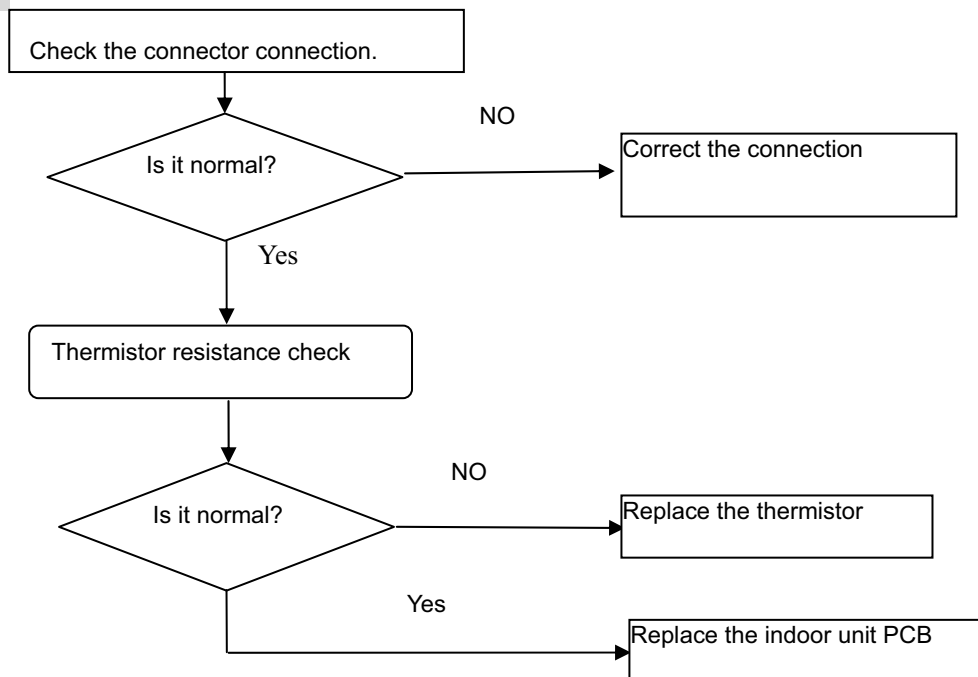

Thermistor resistance check method:

Remove the connector of the thermistor on the PCB, and measure the resistance of thermistor using tester. The relationship between normal temperature and resistance is shown in the value of indoor thermistor.

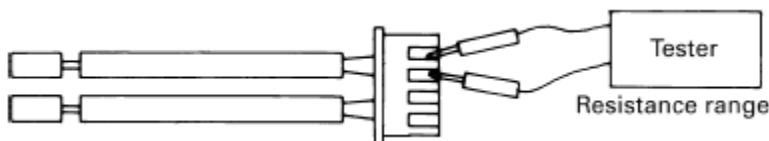

### 10.3.2 EEPROM abnormal

Indoor Display	★ □ ★/ E4: Indoor EEPROM error
Indoor display	■ ★ ■/ F12: Outdoor EEPROM error; Outdoor LED1 flash 1 times
Method of Malfunction Detection	The Data detected by the EEPROM are used to determine MCU
Malfunction Decision Conditions	When the data of EEPROM is error or the EEPROM is damaged
Supposed Causes	<ul style="list-style-type: none"> <li>■ Faulty EEPROM data</li> <li>■ Faulty EEPROM</li> <li>■ Faulty PCB</li> </ul>
Troubleshooting	* Caution Be sure to turn off power switch before connect or disconnect connector, or parts damage may be occurred.

Replace the indoor or outdoor mainboard.

### 10.3.3 Indoor AC fan motor malfunction

Indoor Display ■ □ ★ / E14

Method of Malfunction Detection

The rotation speed detected by the Hall IC during fan motor operation is used to determine abnormal fan motor operation

Malfunction Decision Conditions

when the detected rotation feedback signal don't received in 2 minutes

Supposed Causes

- Operation halt due to breaking of wire inside the fan motor.
- Fan motor overheat protection
- Operation halt due to breaking of the fan motor lead wires
- Detection error due to faulty indoor unit PCB

Troubleshooting

\* Caution Be sure to turn off power switch before connect or disconnect connector, or else parts damage may be occurred.

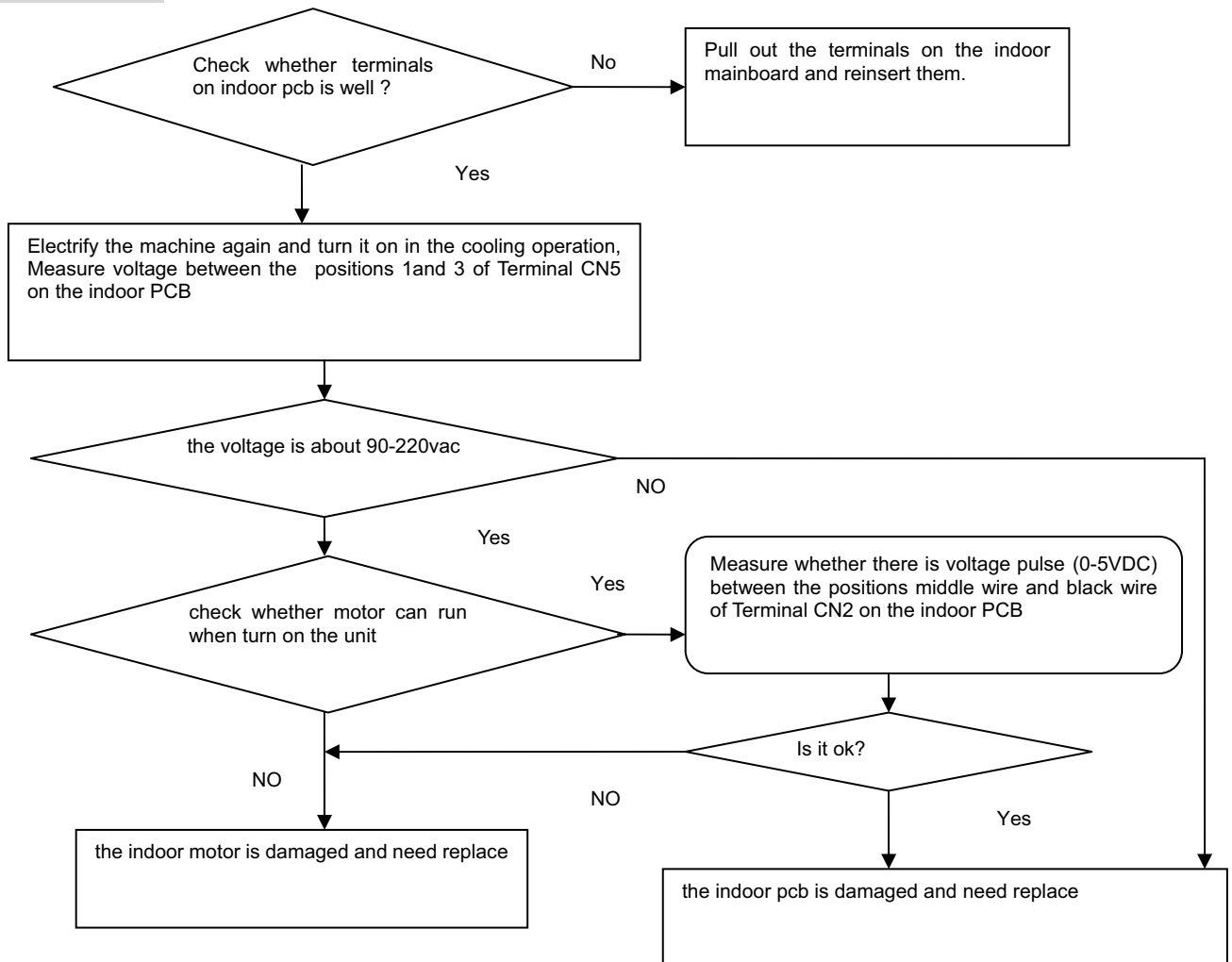

### 10.3.4 Outdoor DC fan motor fault

Outdoor display ■ ★ □/ F8 LED1 flash 9 times

Method of

DC fan motor is detected by checking the fan running condition and so on

Malfunction  
Detection

Malfunction  
Decision

when the data of EEPROM is error or the EEPROM is damaged

Conditions

Supposed  
Causes

■ DC fan motor protection dues to the DC fan motor faulty

■ DC fan motor protection dues to faulty PCB

Troubleshooting

\* Caution Be sure to turn off power switch before connect or disconnect connector, or parts damage may be occurred.

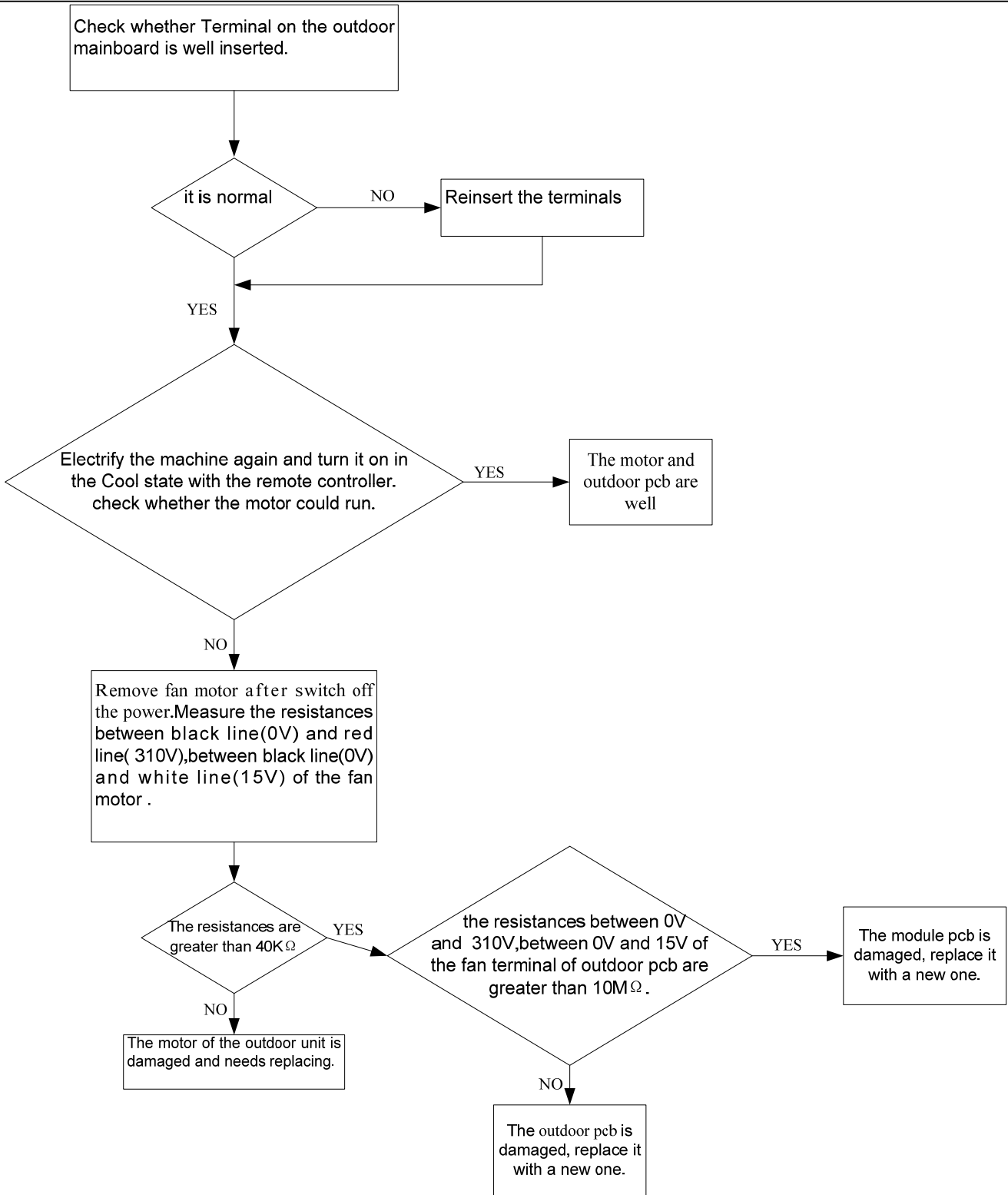

### 10.3.5 IPM protection

Outdoor display:  ★ ★/ F1 LED1 flash 2 times

**Method of Malfunction Detection** IPM protection is detected by checking the compressor running condition and so on

- Malfunction Decision Conditions**
- The system leads to IPM protection due to over current
  - The compressor faulty leads to IPM protection
  - circuit component of IPM is broken and led to IPM protection

- Supposed Causes**
- IPM protection dues to the compressor faulty
  - IPM protection dues to faulty PCB of IPM module
  - Compressor wiring disconnected

**Troubleshooting** \* Caution Be sure to turn off power switch before connect or disconnect connector, or else parts damage may be occurred.

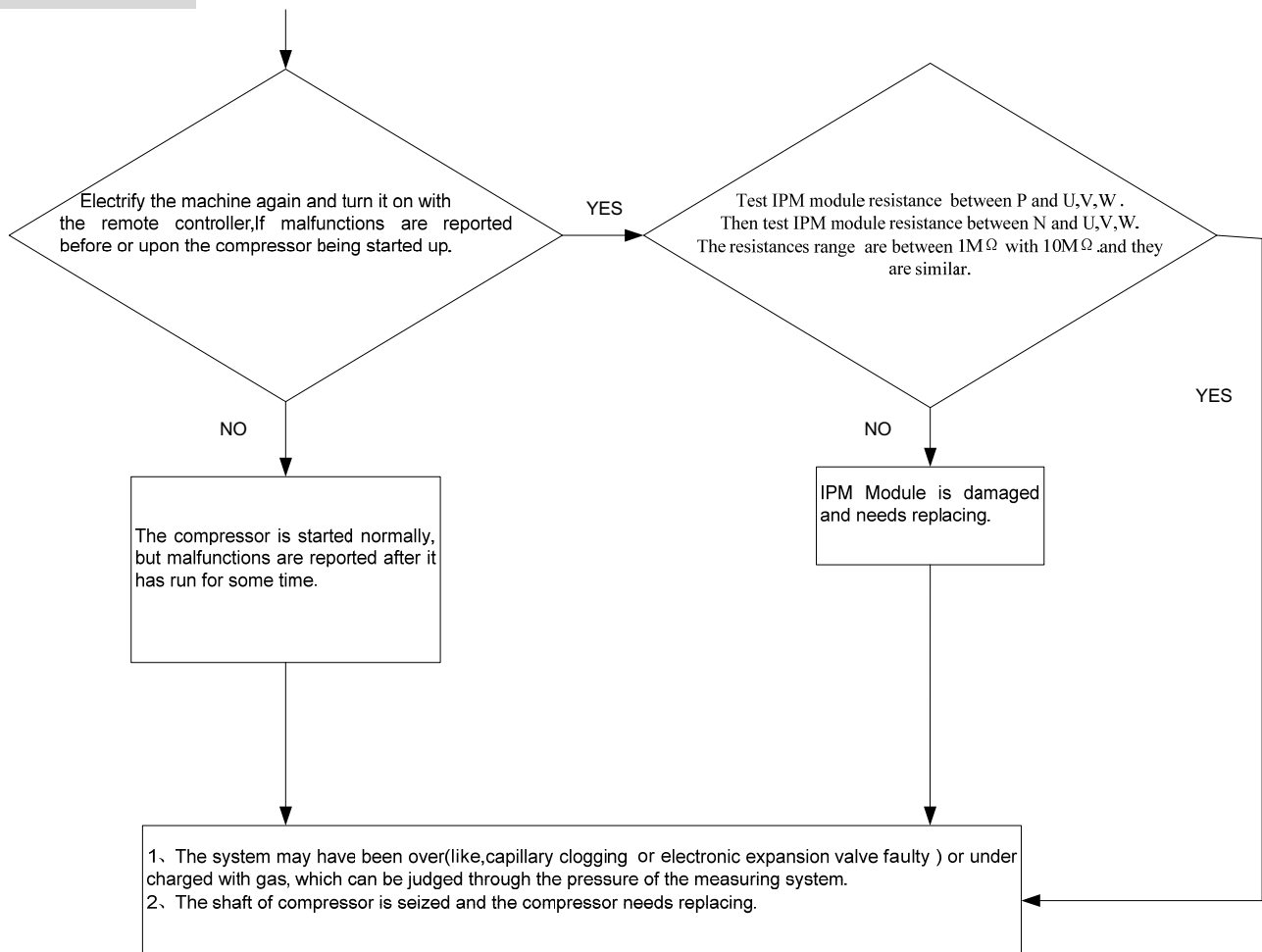



### 10.3.6 Over-current of the compressor

Outdoor Display: \_\_\_\_\_  
 ■ ★ □/ F2 LED1 flash 3 or 24 or 25 times

**Method of Malfunction Detection** \_\_\_\_\_  
 The current of the compressor is too high

**Malfunction Decision Conditions** \_\_\_\_\_  
 when the IPM Module is damaged or the compressor is damaged.  
 power supply voltage is too low or too high

**Supposed Causes** \_\_\_\_\_  
 ■ Faulty IPM Module  
 ■ Faulty compressor  
 ■ Faulty power supply

**Troubleshooting** \* Caution Be sure to turn off power switch before connect or disconnect connector, or parts damage may be occurred.

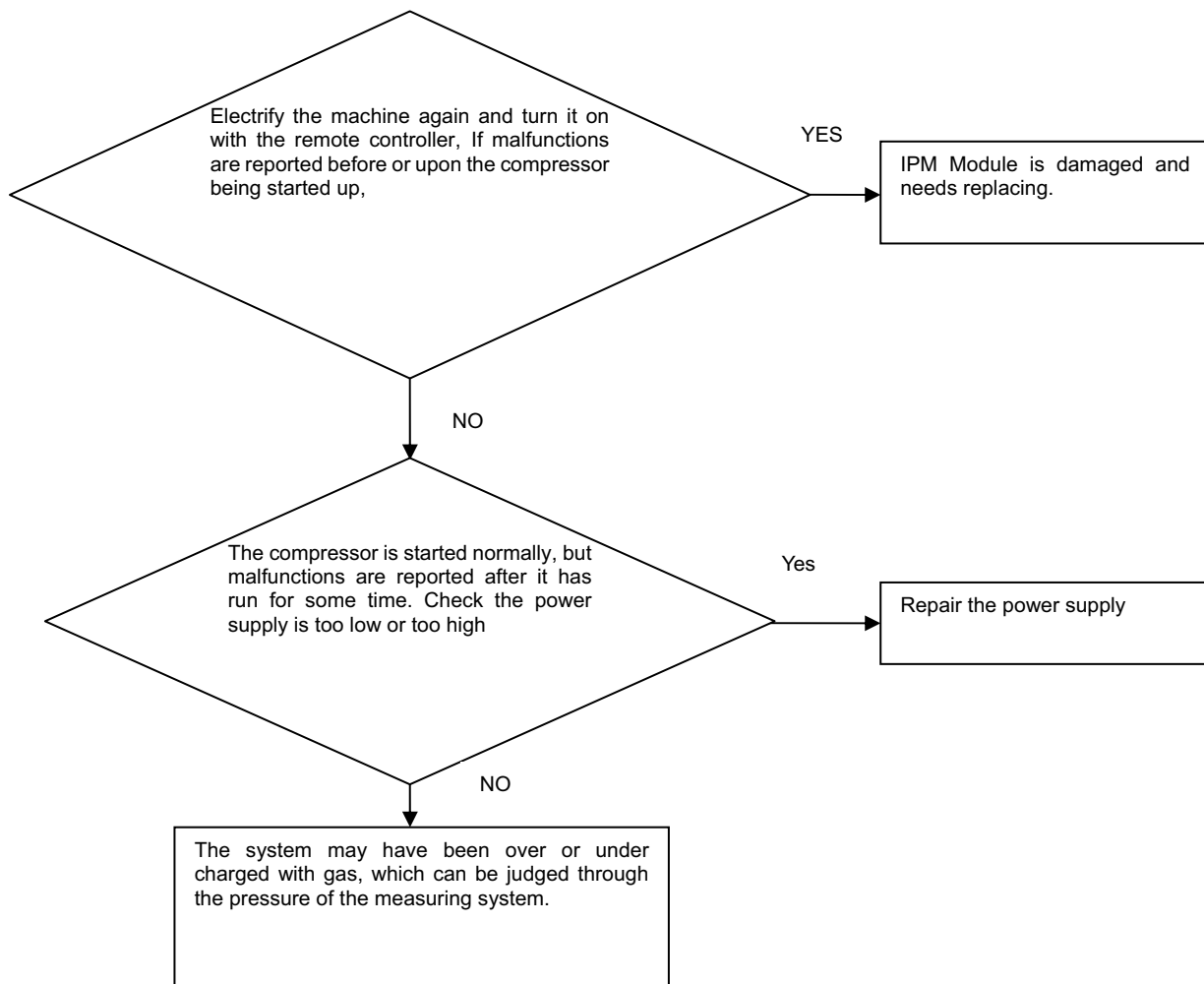

### 10.3.7 The communication fault between IPM and outdoor PCB

Outdoor display: ■ ★ ■ / F3 LED1 flash 4 times

**Method of Malfunction Detection**

Communication is detected by checking the IPM module and the outdoor PCB

**Malfunction Decision Conditions**

- The outdoor PCB broken leads to communication fault
- The IPM module broken leads to communication fault

**Supposed Causes**

- The outdoor PCB is broken
- The IPM module is broken
- Communication wiring disconnected

**Troubleshooting**

\* Caution Be sure to turn off power switch before connect or disconnect connector, or else parts damage may be occurred.

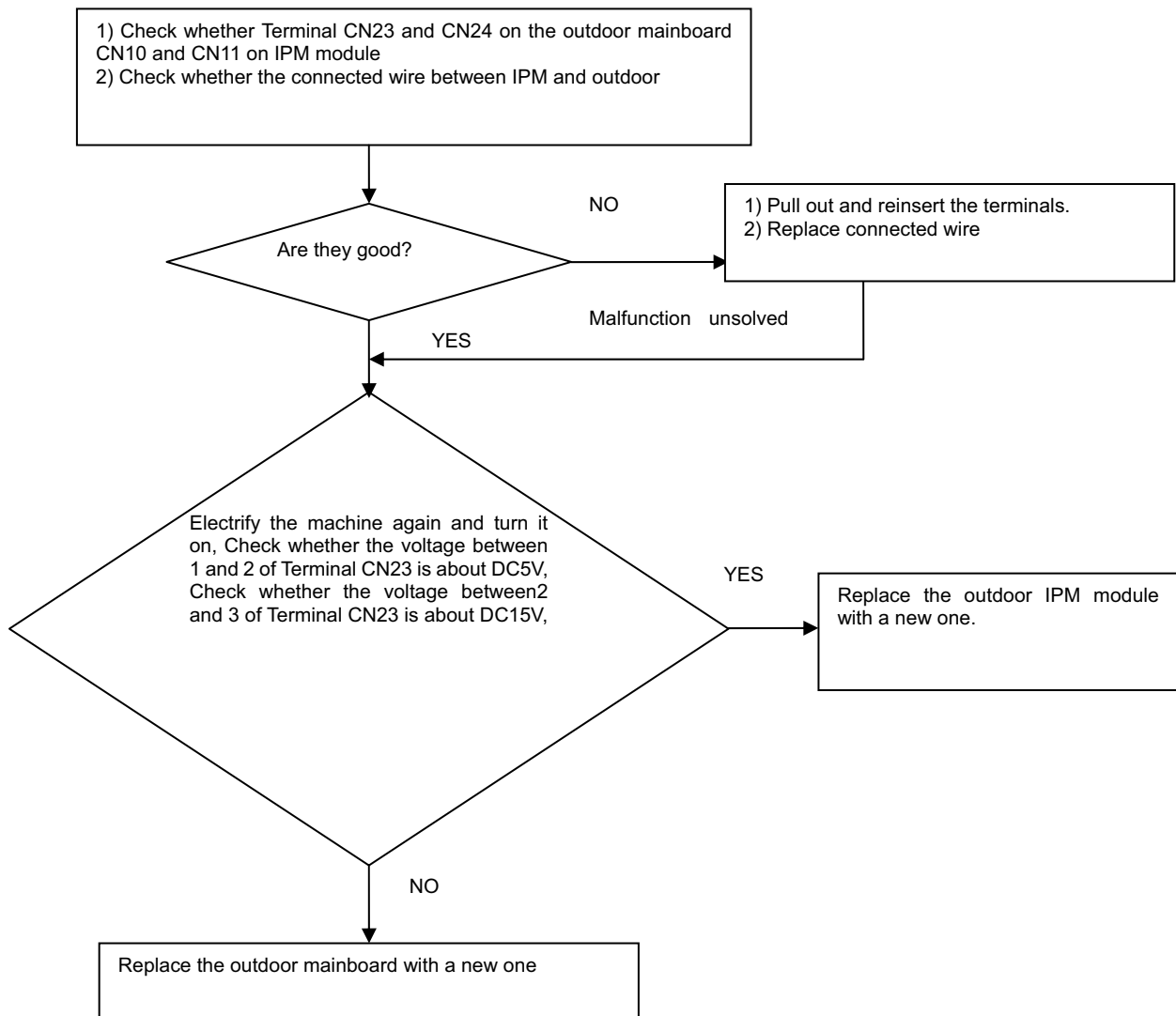

### 10.3.8 Power Supply Over or under voltage fault

Outdoor display: ■ ★ □/ F19 LED1 flash 6 times The power supply is over voltage

**Method of Malfunction Detection** An abnormal voltage rise or fall is detected by checking the specified voltage detection circuit.

**Malfunction Decision Conditions** An voltage signal is fed from the voltage detection circuit to the microcomputer

**Supposed Causes**

- Supply voltage not as specified
- the IPM module is broken
- the outdoor PCB is broken

**Troubleshooting** \* Caution Be sure to turn off power switch before connect or disconnect connector, or else parts damage may be occurred.

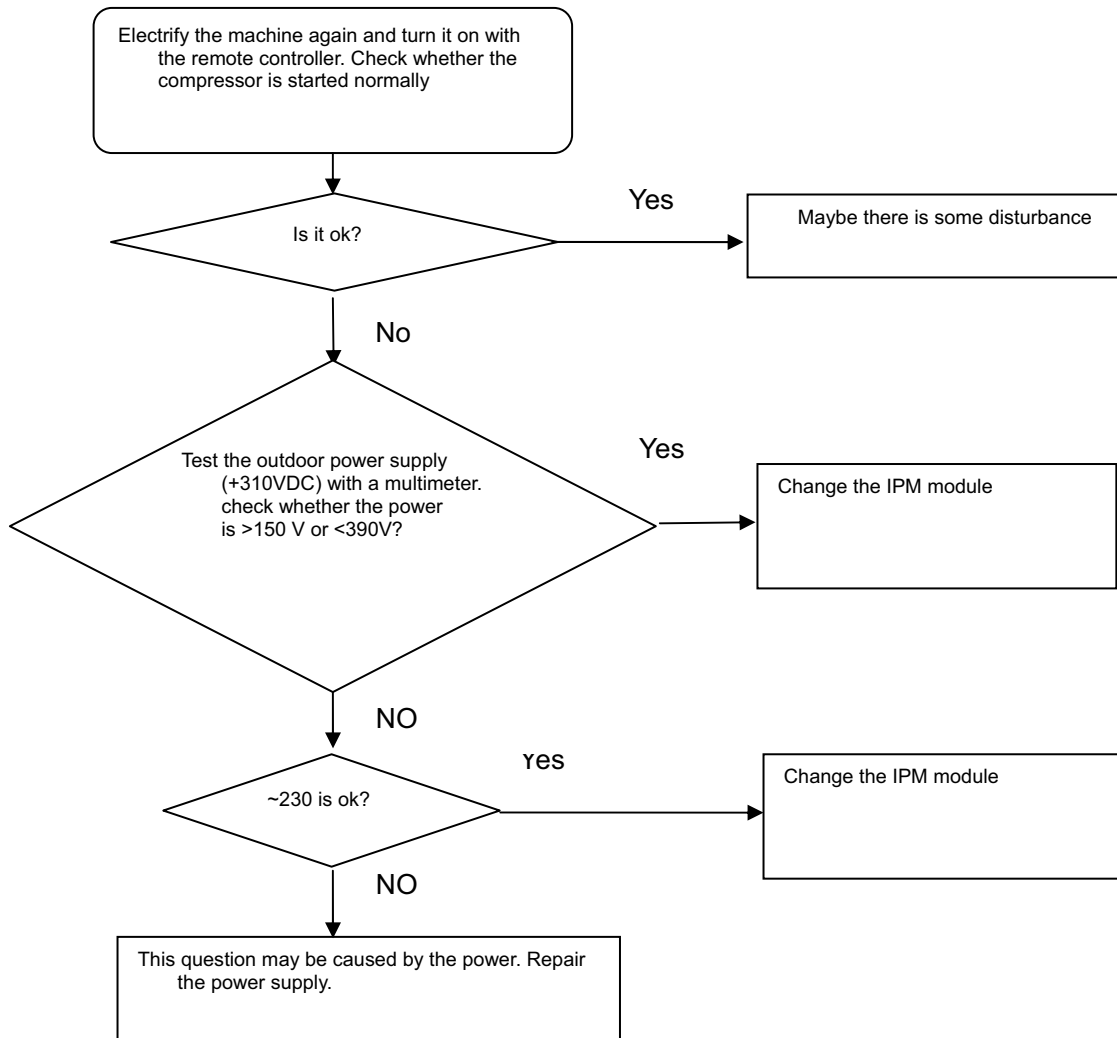

### 10.3.9 Overheat Protection For Discharge Temperature

Outdoor display: ■ ★ ■ / F4 LED1 flash 8 times

Method of Malfunction Detection	The Discharge temperature control is checked with the temperature being detected by the Discharge pipe thermistor	
Malfunction Decision Conditions	when the compressor discharge temperature is above 110°C	
Supposed Causes	<ul style="list-style-type: none"> <li>■ Electronic expansion valve defective</li> <li>■ Faulty thermistor</li> <li>■ Faulty PCB</li> </ul>	
Troubleshooting	* Caution Be sure to turn off power switch before connect or disconnect connector, or else parts damage may be occurred.	

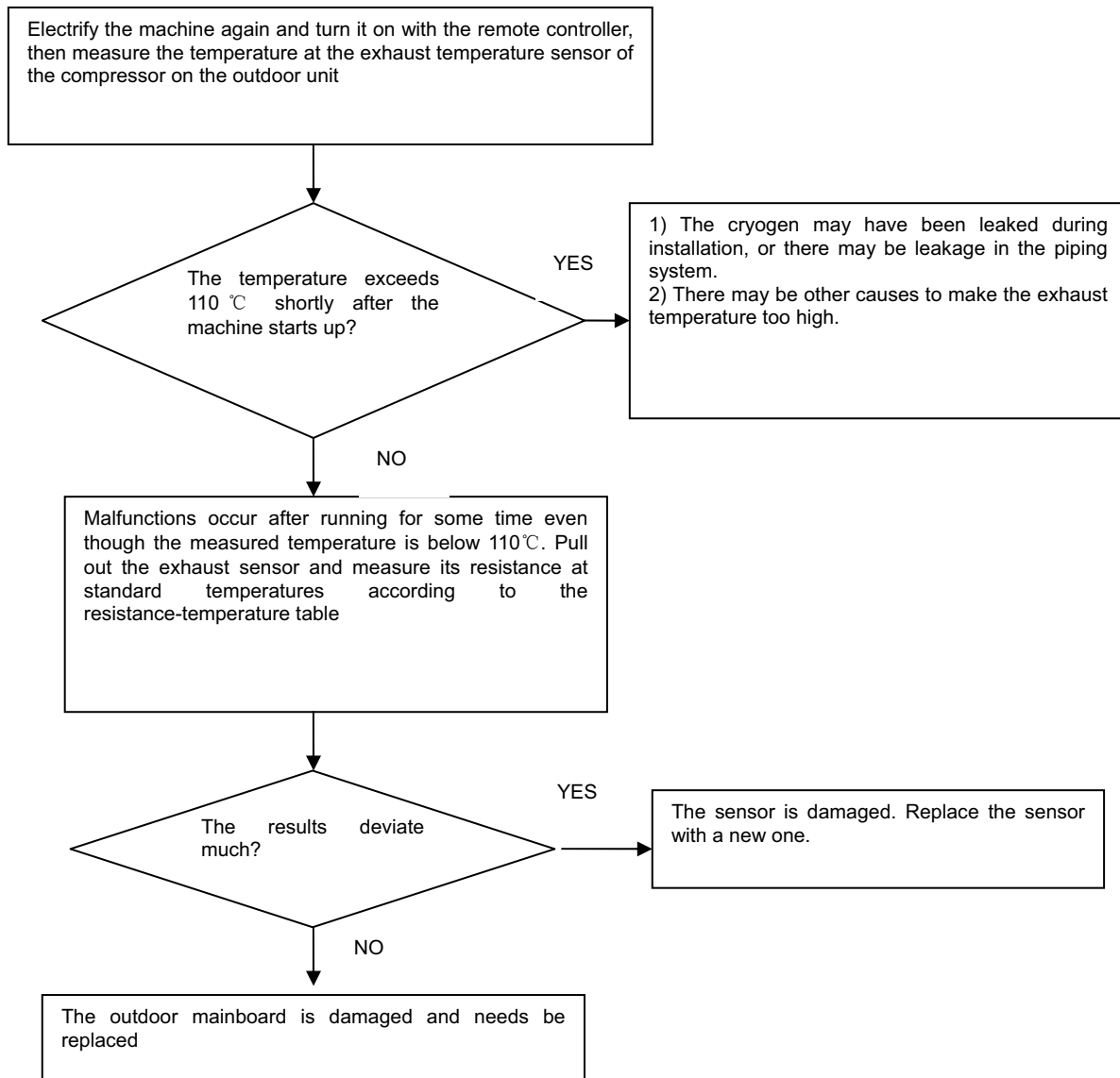

### 10.3.10 The communication fault between indoor and outdoor

Indoor display  
outdoor display

■ ■ ★/ E7  
LED1 flash 15 times

Method of  
Malfunction  
Detection

Communication is detected by checking the indoor PCB and the outdoor PCB.

Malfunction  
Decision  
Conditions

- The outdoor PCB broken leads to communication fault.
- The indoor PCB broken leads to communication fault.

Supposed  
Causes

- Communication wiring disconnected.
- The indoor PCB is broken.
- The outdoor PCB is broken.
- The Module PCB is broken.

Troubleshooting

\* Caution Be sure to turn off power switch before connect or disconnect connector, or else parts damage may be occurred.

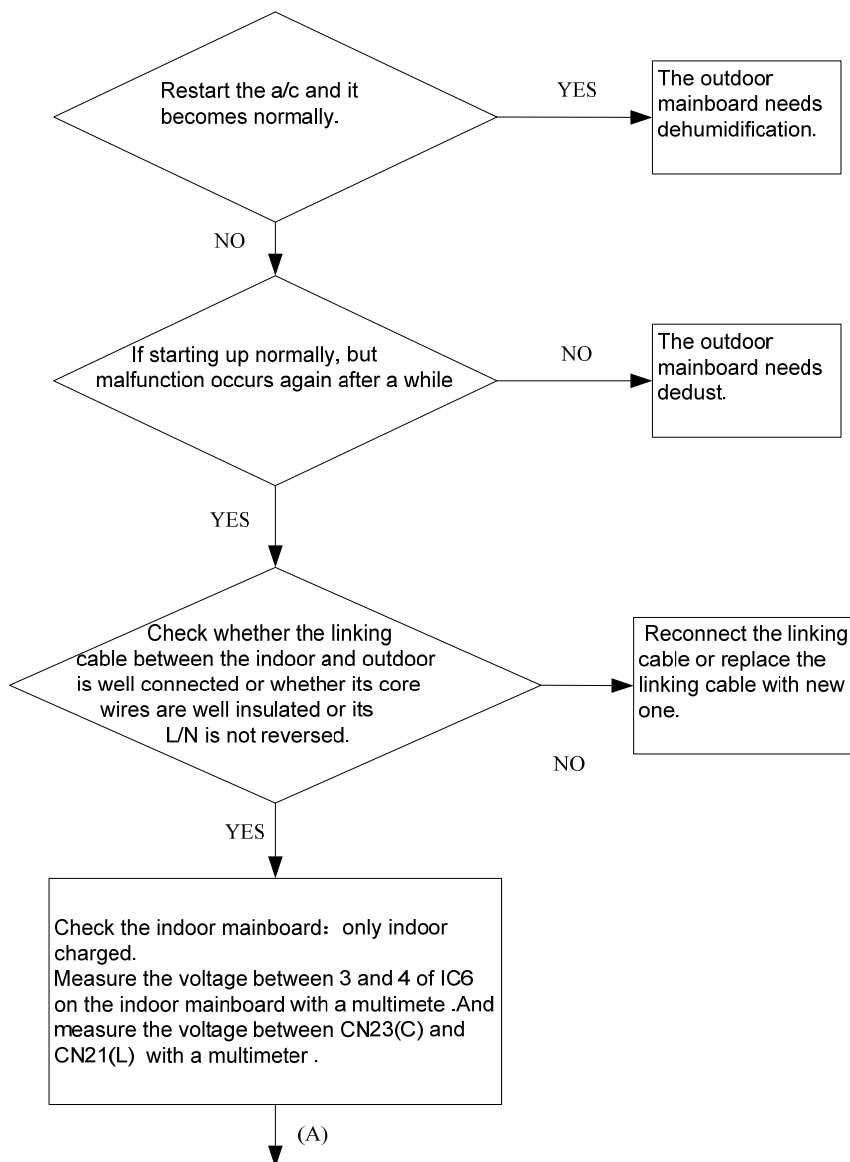

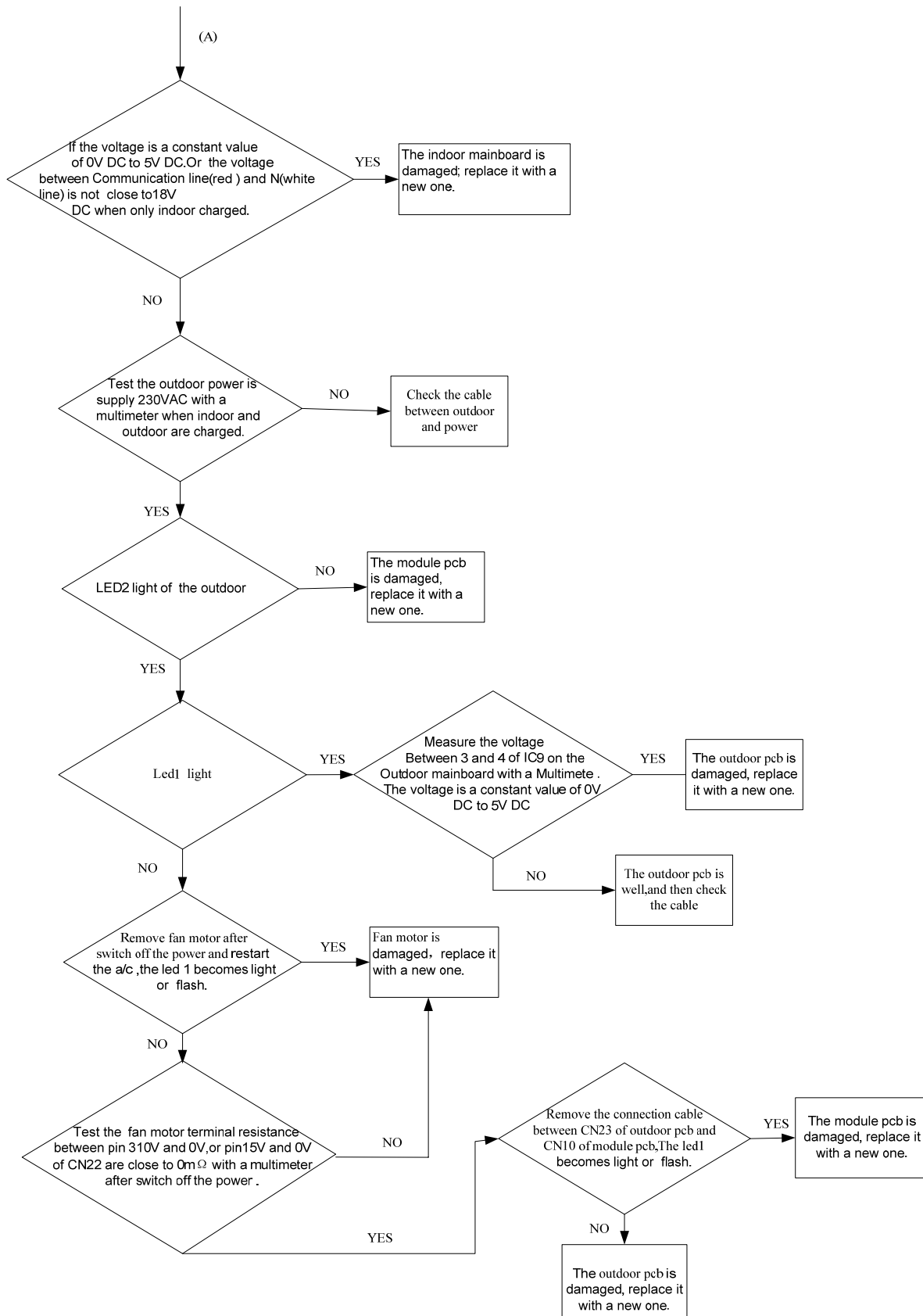

### 10.3.11 Loss of synchronism detection Inverter side current detection is abnormal

Outdoor Display ■ ★ ■ \ F11 LED1 flash 18 times  
 ■ ★ ■ \F28 LED1 flash 19 times

**Method of Malfunction Detection** The position of the compressor rotor can not detected normally

**Malfunction Decision Conditions** when the wiring of compressor is wrong or the connection is poor; or the compressor is damaged

**Supposed Causes**  
 ■ Faulty The wiring of compressor  
 ■ Faulty compressor  
 ■ Faulty PCB

**Troubleshooting** \* Caution Be sure to turn off power switch before connect or disconnect connector, or parts damage may be occurred.

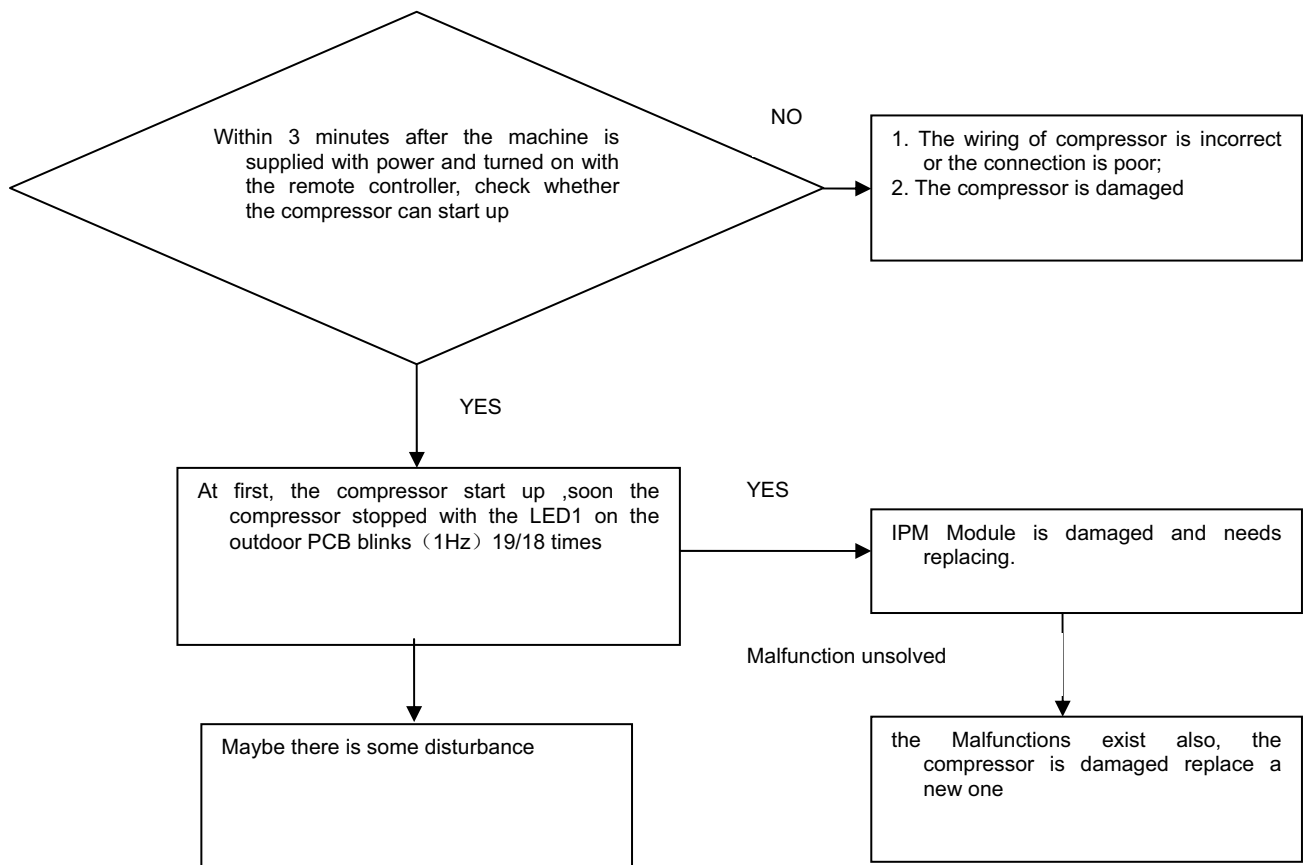

10.3.12 High work-intense protection

Outdoor display      ★ ★ ★\E9 LED1 flash 21 times

Method of Malfunction Detection

High work-intense control is activated in the heating mode if the temperature being sensed by the heat exchanger thermistor exceeds the limit.

Malfunction Decision Conditions

Activated when the temperature being sensed by the heat exchanger rises above 65°C twice in 30 minutes.

Supposed Causes

- Faulty electronic expansion valve
- Dirty heat exchanger
- Faulty heat-exchange sensor
- Insufficient gas

Troubleshooting

\* Caution Be sure to turn off power switch before connect or disconnect connector, or else parts damage may be occurred.

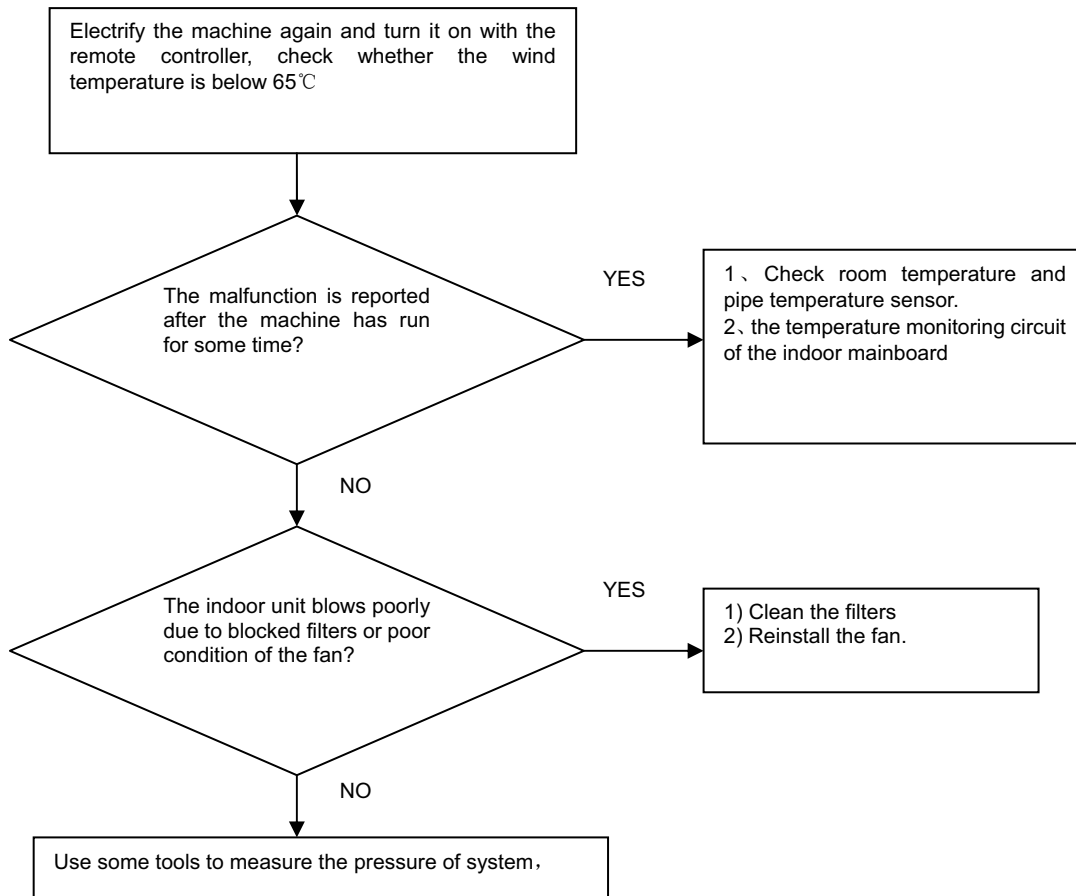



# 11. Performance and curves diagrams

## 11.1 Cooling capacity-temperature curves

AS18NDHHRA 1U18REHFRA performance curves									
cooling value-temperature table									
indoor temp.									
DB/WB	-10°C	0°C	10°C	20°C	25°C	30°C	35°C	40°C	46°C
18/12°C	2883	3706	3222	4296	4369	4686	4997	4432	3789
21/15°C	3049	3873	3407	4506	4583	4998	5274	4559	3957
24/16°C	3426	4365	3716	5148	5172	5426	5854	5188	4449
27/19°C	3583	4552	3963	5387	5382	5794	6130	5426	4723
30/22°C	3814	4803	4232	5660	5737	6063	6604	5842	5028
32/23°C	4002	5013	4358	5862	6014	6403	6722	5919	5170

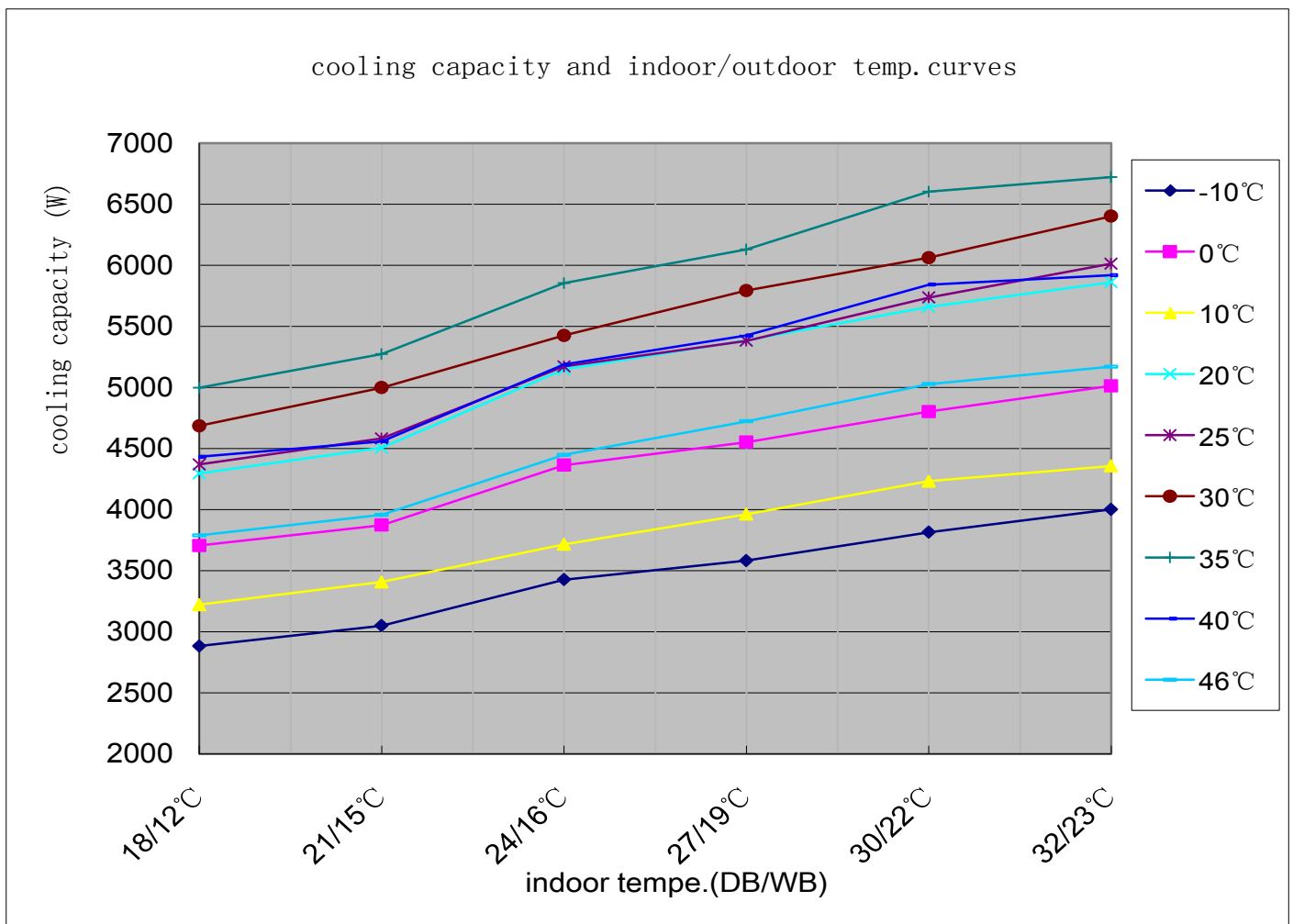

11.2 Cooling power consumption value- temperature curves

AS18NDHHRA 1U18REHFRA performance curves									
power consumption value-temp.table									
indoor temp.									
DB/WB	-10°C	0°C	10°C	20°C	25°C	30°C	35°C	40°C	46°C
18/12°C	184	244	287	549	787	1060	1567	1461	1362
21/15°C	189	254	300	585	826	1112	1646	1542	1429
24/16°C	214	280	330	655	920	1221	1844	1713	1621
27/19°C	224	299	351	678	977	1288	1928	1785	1687
30/22°C	237	315	370	715	1047	1371	2031	1884	1808
32/23°C	243	326	382	739	1058	1426	2115	1988	1851

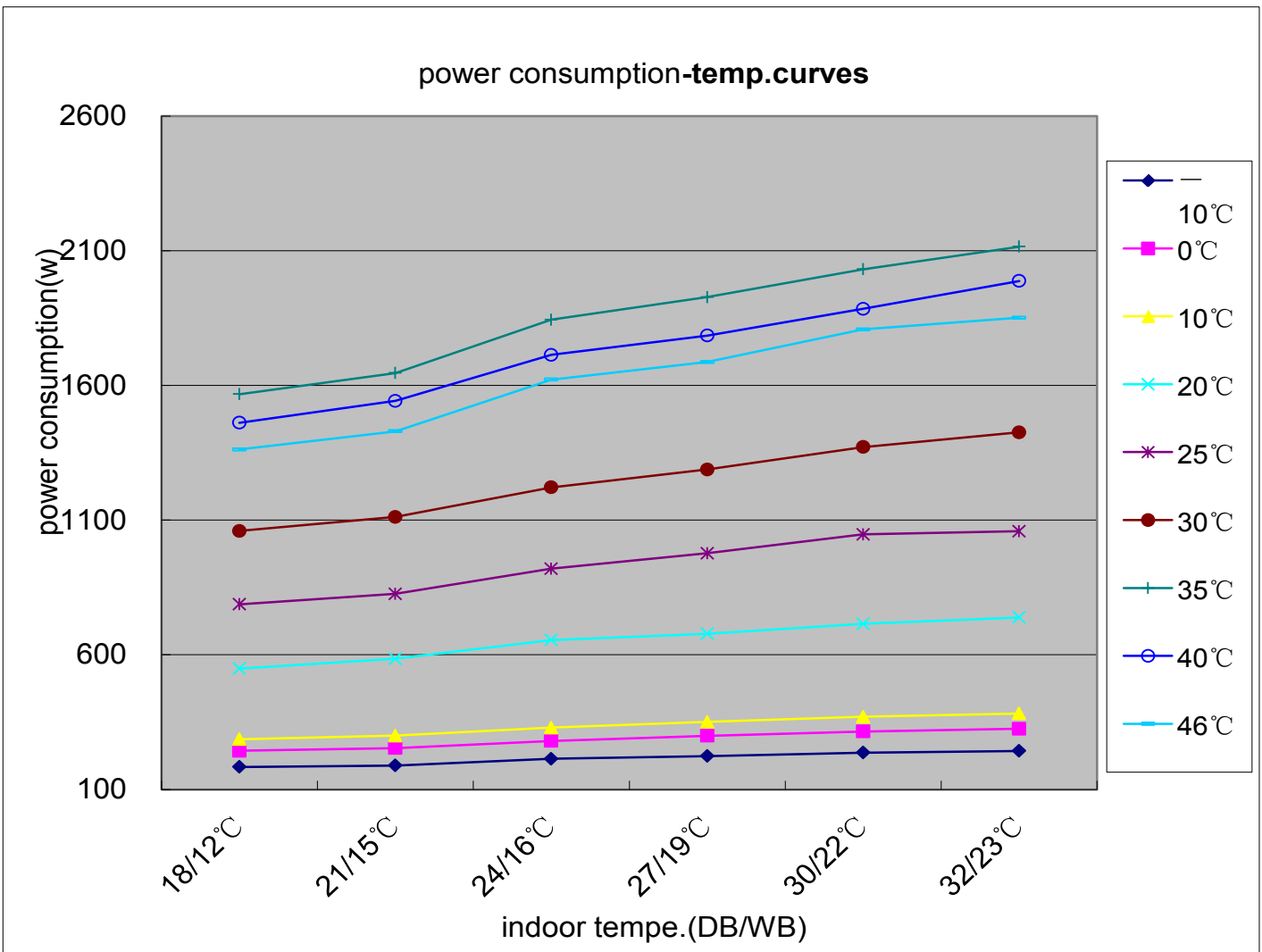

### 11.3 Cooling discharge pressure curves

performance curves			
cooling discharge pressure.table			
outdoor temp. (humidity 46%)	indoor temp.		
DB/WB	21/15°C	27/19°C	35/24°C
10°C	1899	2010	2107
15°C	1949	2037	2141
20°C	1976	2064	2178
25°C	2079	2144	2287
30°C	2211	2385	2478
35°C	2429	2546	2674
38°C	2615	2734	2901
40°C	2940	3082	3234
43°C	3359	3484	3650

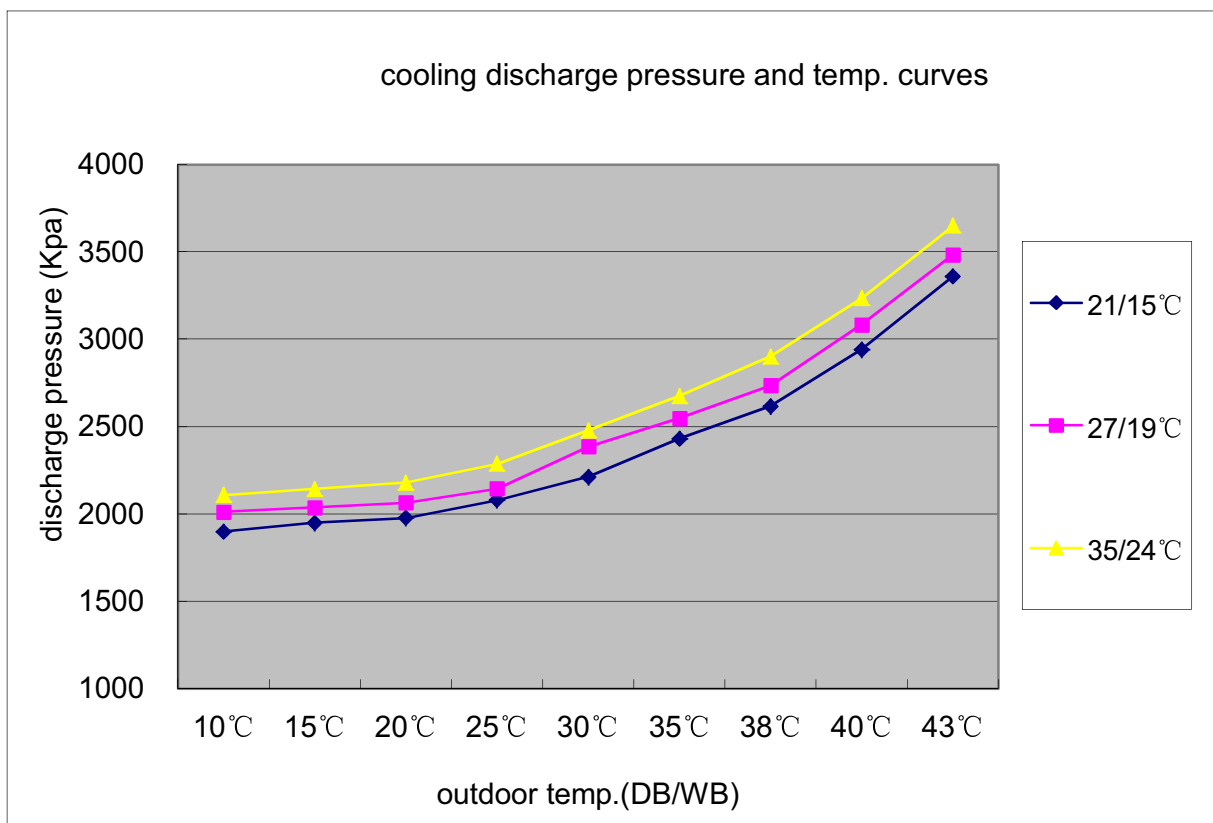

### 11.4 Cooling suction pressure curves

performance curves			
cooling suction pressure.table			
outdoor temp. (humidity 46%)	indoor temp.		
DB/WB	21/15°C	27/19°C	35/24°C
10°C	757	886	1029
15°C	765	895	1040
20°C	772	913	1050
25°C	813	922	1072
30°C	856	971	1082
35°C	864	981	1139
38°C	910	1011	1163
40°C	1001	1112	1279
43°C	1101	1201	1394

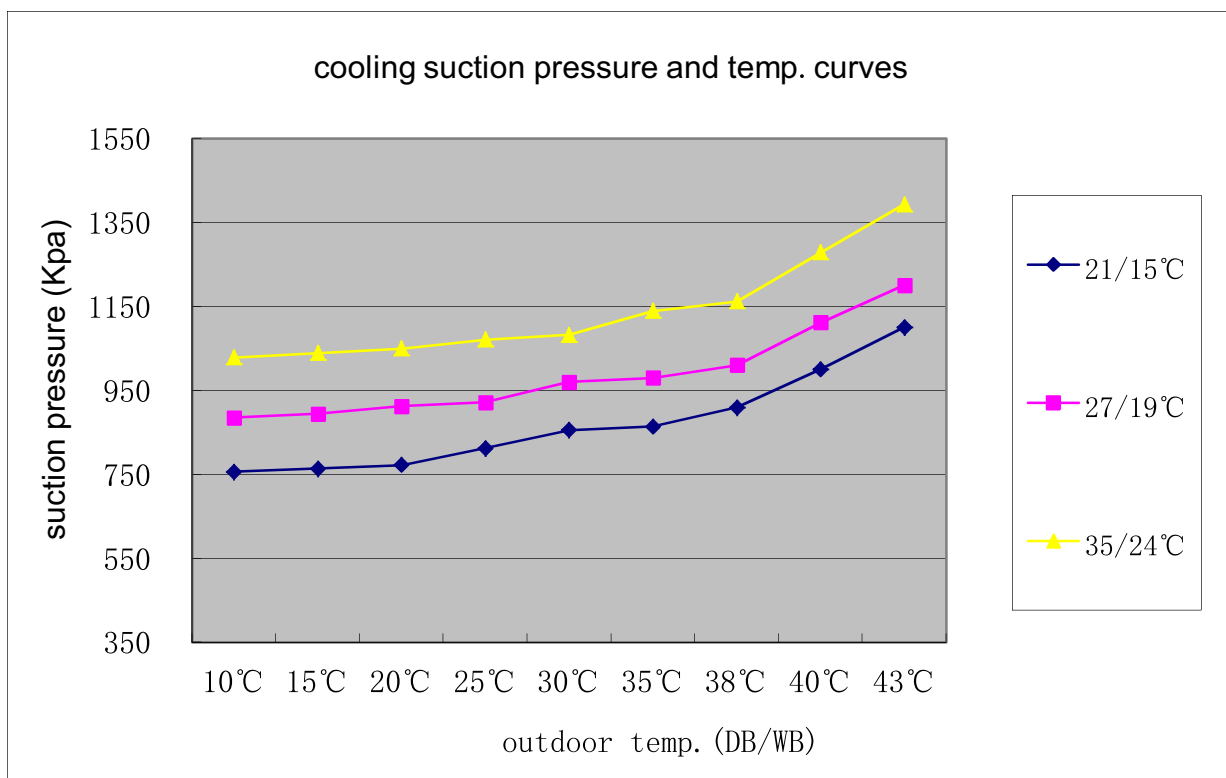

### 11.5 Heating capacity-temperature curves

AS18NDHHRA 1U18REHFRA performance curves			
heating capacity and indoor/outdoor temp. table			
outdoor temp.	indoor temp. (humidity 46%)		
DB/WB	10°C	20°C	27°C
-30	2812	2445	2078
-25	4096	3562	3028
-20	4930	4287	3644
-15	5950	5174	4398
-10	6353	5524	4695
-7/-8	6618	5755	4892
2/1	7032	6115	5198
7/6	7217	6276	5335
12/11	7147	6215	5283
18/16	6772	5889	5006
24/20	6164	5360	4556

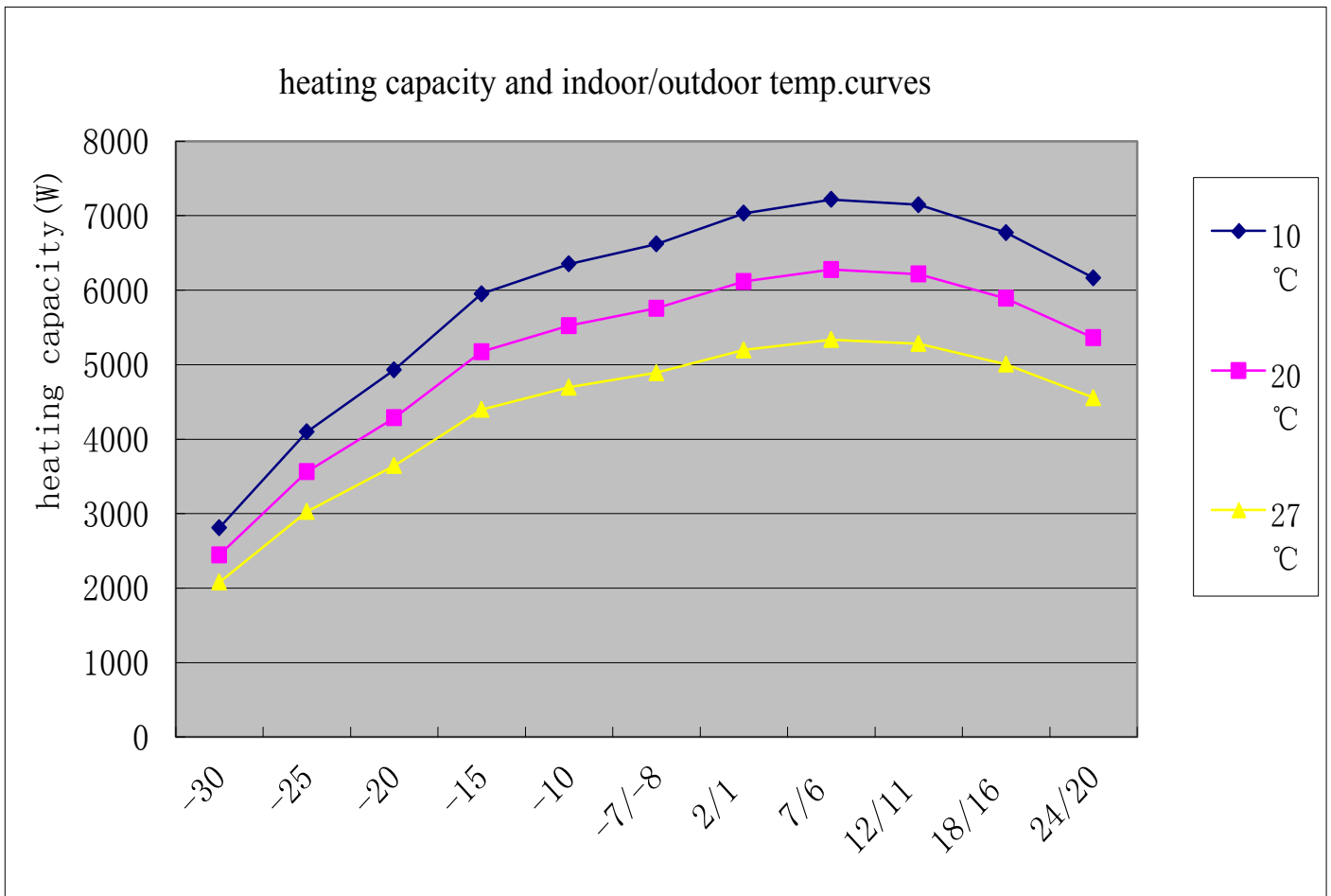

### 11.6 Heating power consumption value- temperature curves

AS18NDHHRA 1U18REHFRA performance curves			
power consumption value-temp.table			
outdoor temp.	indoor temp.(humidity 46%)		
DB/WB	10°C	20°C	27°C
-30	1676	1862	2048
-25	1972	2191	2410
-20	2089	2321	2553
-15	2425	2694	2963
-10	2462	2735	3009
-7/-8	2571	2857	3143
2/1	2320	2578	2836
7/6	1911	2123	2335
12/11	1519	1688	1857
18/16	1472	1636	1800
24/20	1300	1444	1588

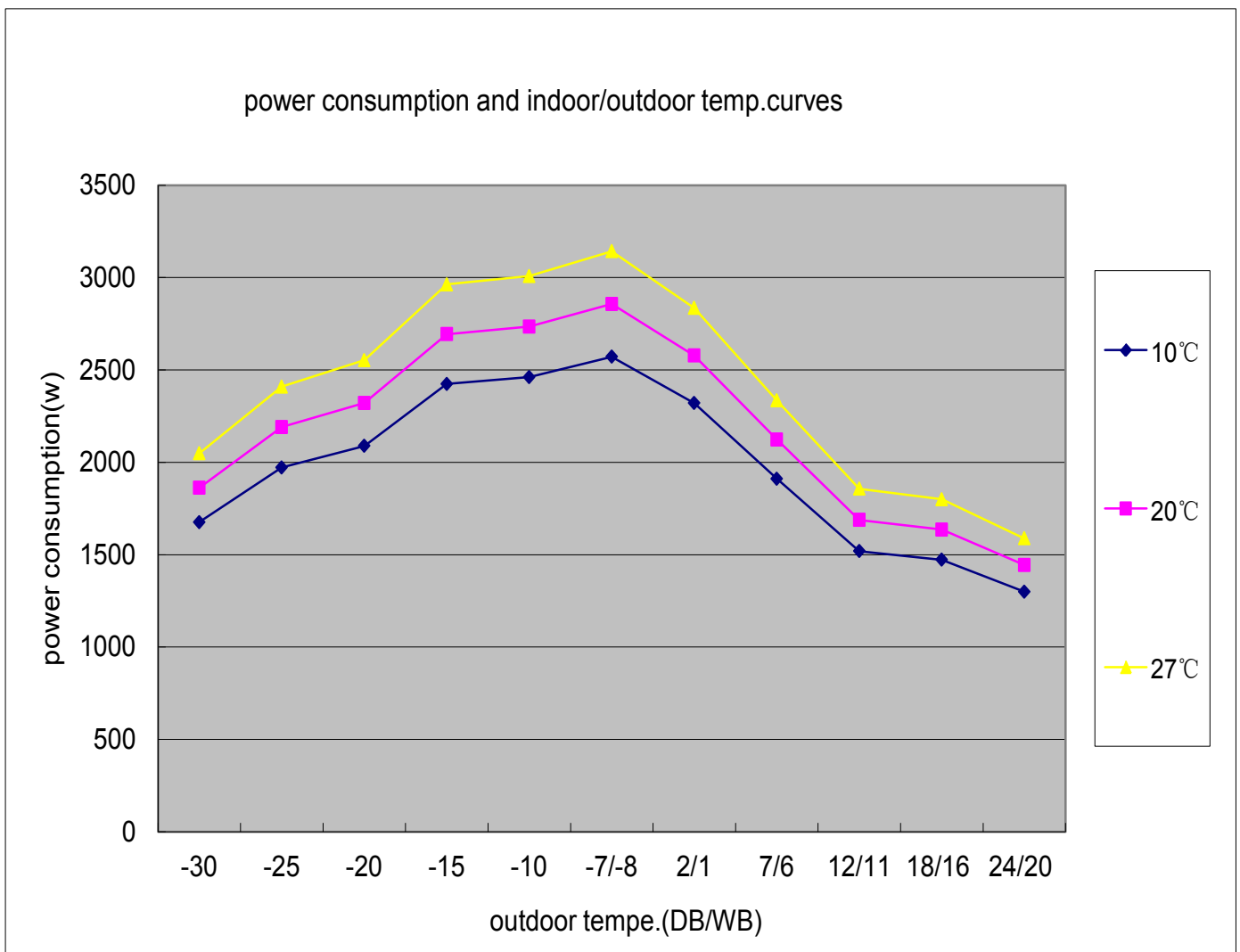

### 11.7 Heating discharge pressure curves

performance curves			
heating discharge pressure.table			
outdoor temp	indoor temp.		
DB/WB	10℃	20℃	27℃
-15℃	2644	2764	2867
-10℃	2789	2980	3073
-7/-8℃	3259	3411	3563
2/1℃	3461	3698	3883
7/6℃	3409	3590	3672
12/11℃	3346	3482	3606
18/16℃	3098	3273	3351
24/20℃	2638	2782	2923

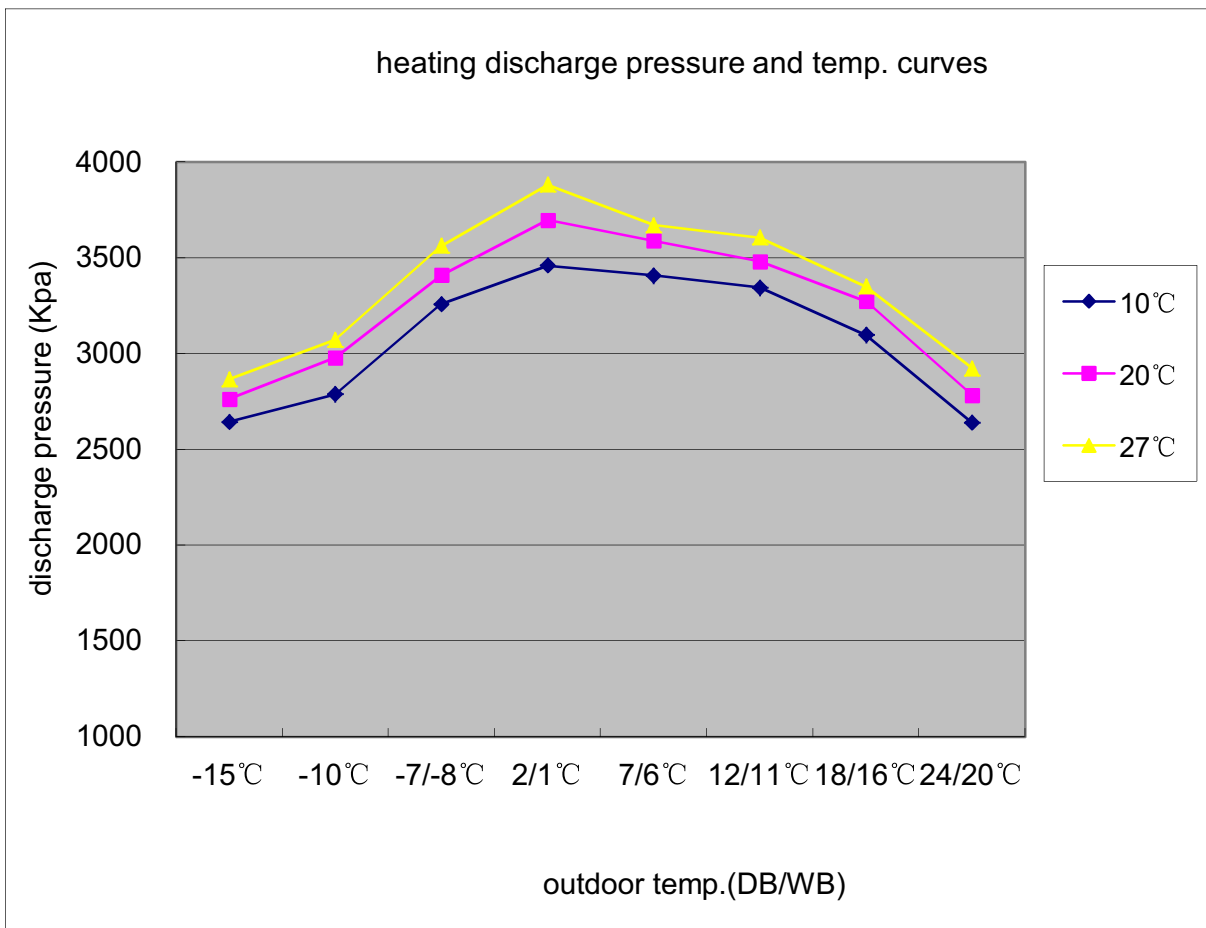

### 11.8 Heating suction pressure curves

performance curves			
heating suction pressure.table			
outdoor temp	indoor temp.		
DB/WB	10℃	20℃	27℃
-15℃	345	385	405
-10℃	398	428	447
-7/-8℃	492	532	551
2/1℃	611	651	670
7/6℃	744	784	803
12/11℃	844	884	904
18/16℃	1011	1051	1071
24/20℃	1197	1237	1257

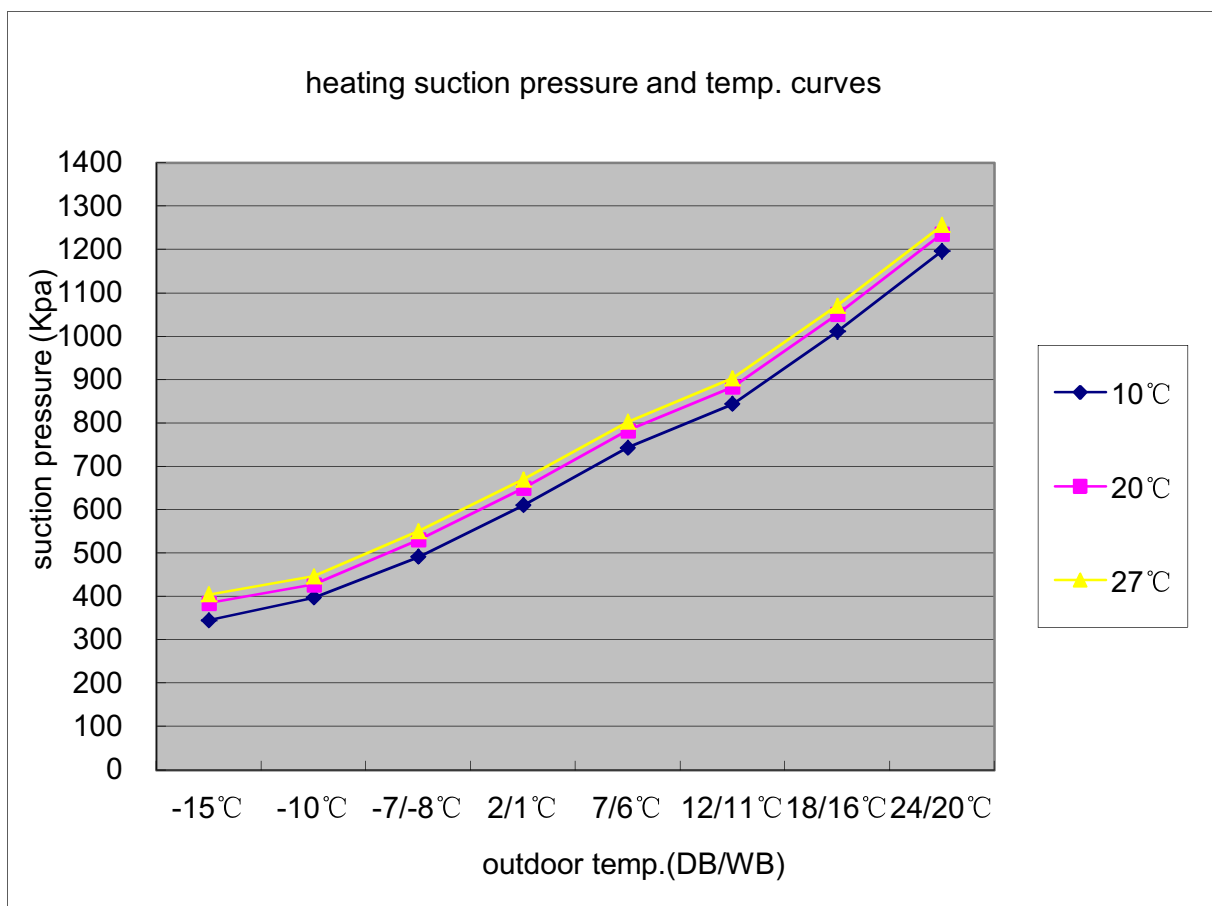



## 12. Circuit diagrams

### 12.1 Outdoor unit control board circuit diagrams

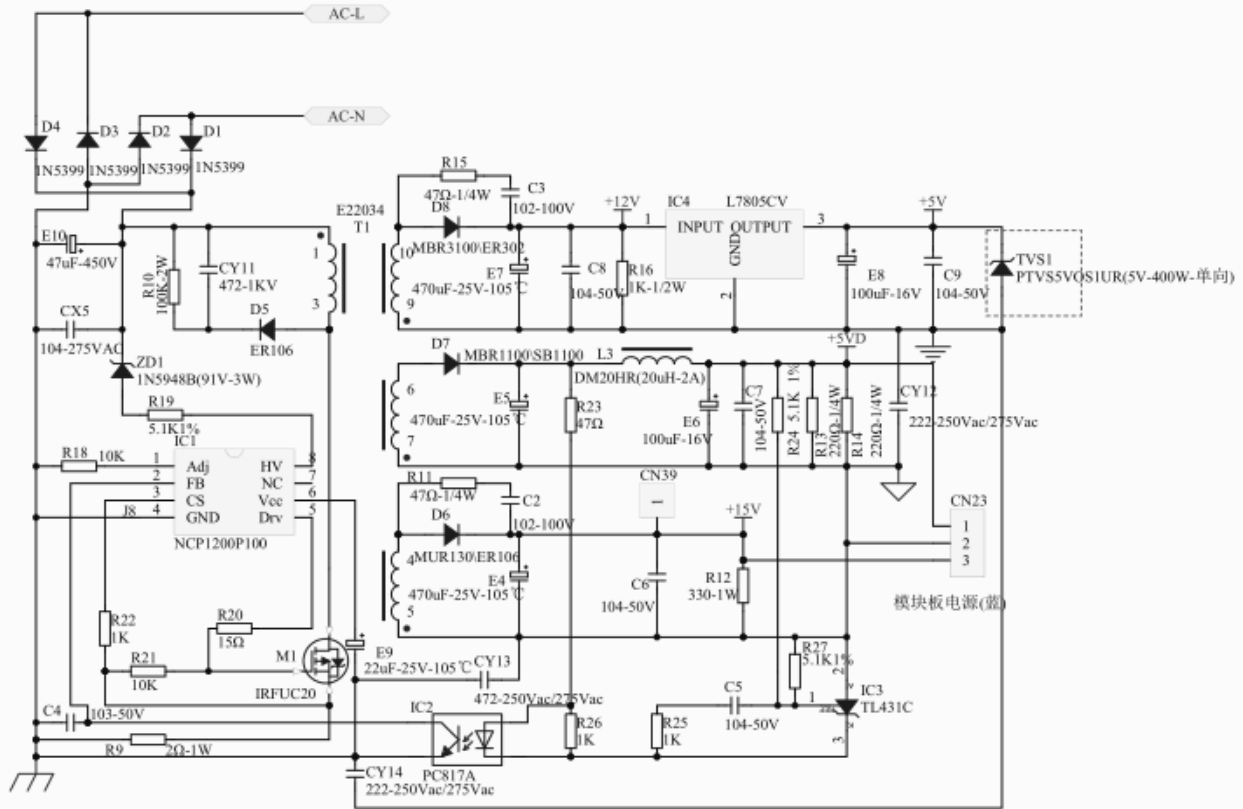

注：CN39焊接到CN42

### 12.2 Module board circuit diagram

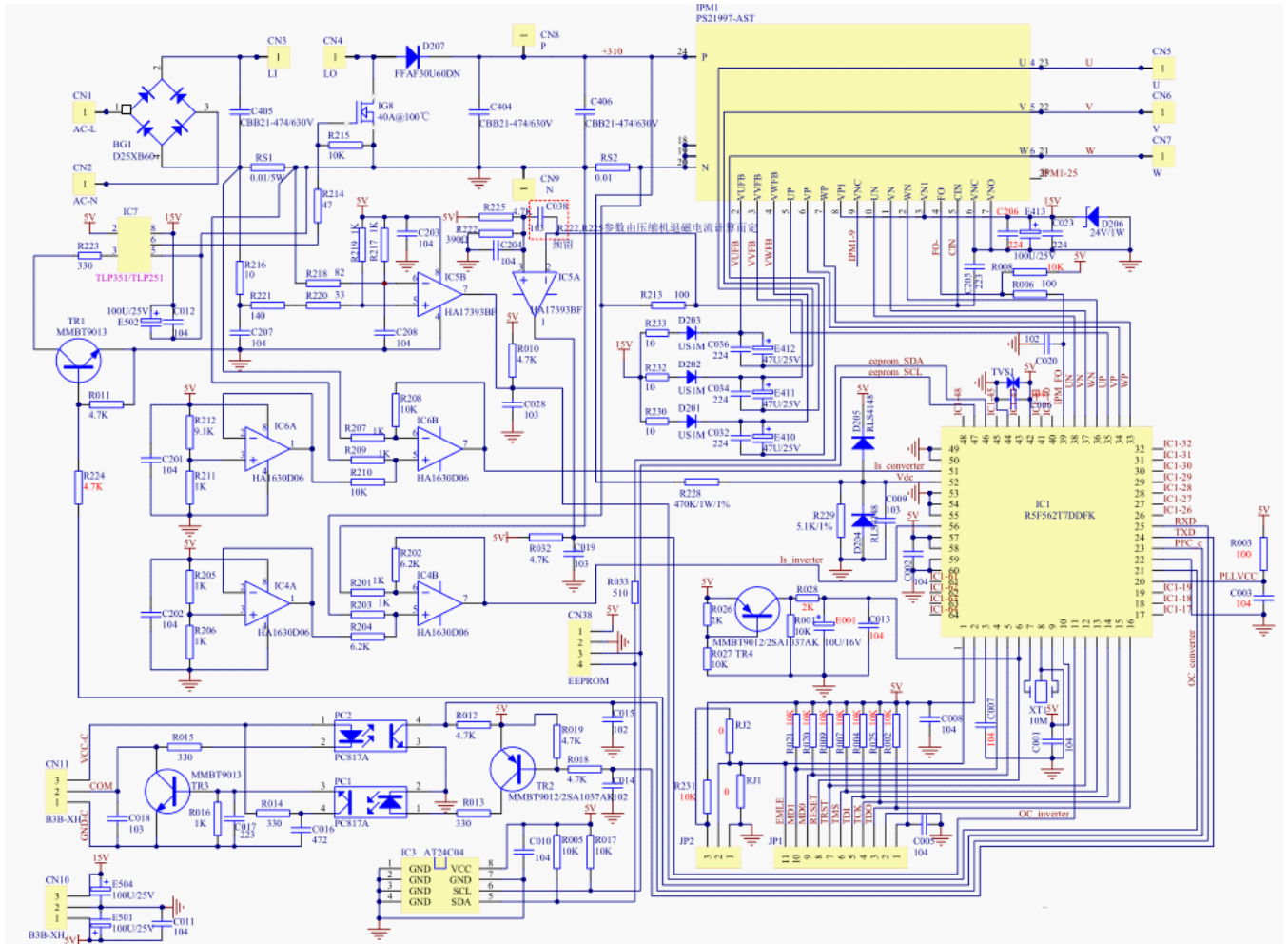

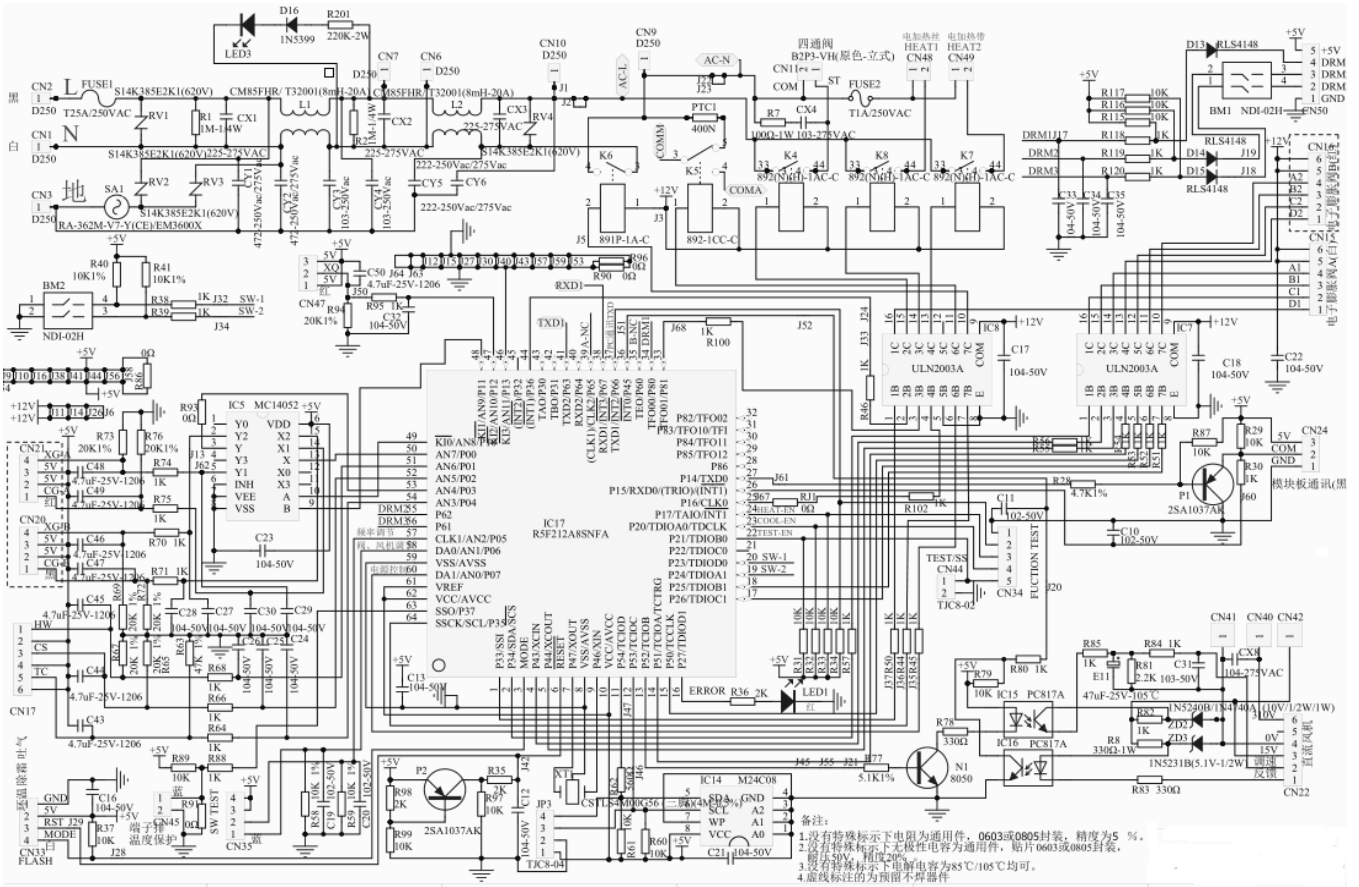

# Sincere Forever

## Haier Group

---

Haier Industrial Park, No.1, Haier Road

266101, Qingdao, China\_

Http: //www.haier.com

Edited by : Shi Haiyan

Yang Xiaodong

Signed by : Yang Wenjun

Approved by: Wu Hongjin



# REMOVAL PROCEDURE

## Wall Mounted Type DC Inverter FREE MATCH EK-Series SERIES: 1U50S2SQ1FA-NR



### **WARNING**

This service information is designed for experienced repair technicians only and is not designed for use by the general public. It does not contain warnings or cautions to advise non-technical individuals of potential dangers in attempting to service a product. Products powered by electricity should be serviced or repaired only by experienced professional technicians. Any attempt to service or Repair the product or products dealt with in this service information by anyone else could result in serious injury or death

2015 (Qingdao Haier Air Conditioner General corp. , Ltd)  
All rights reserved. Unauthorized copying and distribution is a violation of law

**Haier Group**

Version: V1

Date: 2015-01-22

# 1. Removal of Outdoor panel

Procedure

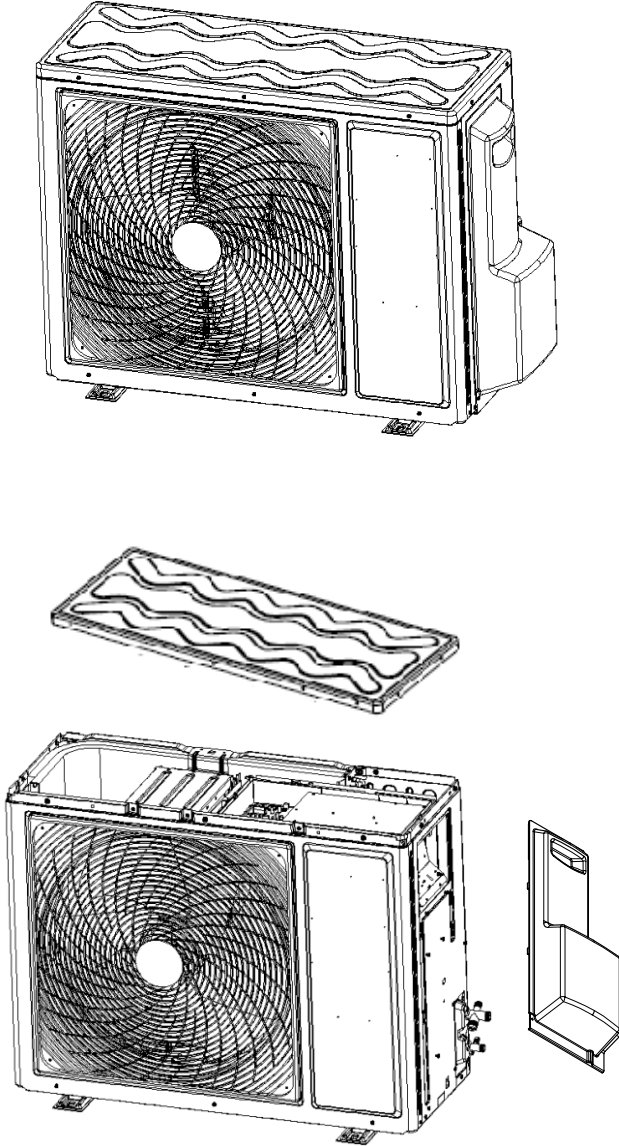

Warning Be sure to wait 10 minutes or more after turning off all power supplies before disassembling work

Step		Procedure	Points
1.	Remove the panels		
1	Loosen the screws and lift the top panel and remove the handle.		

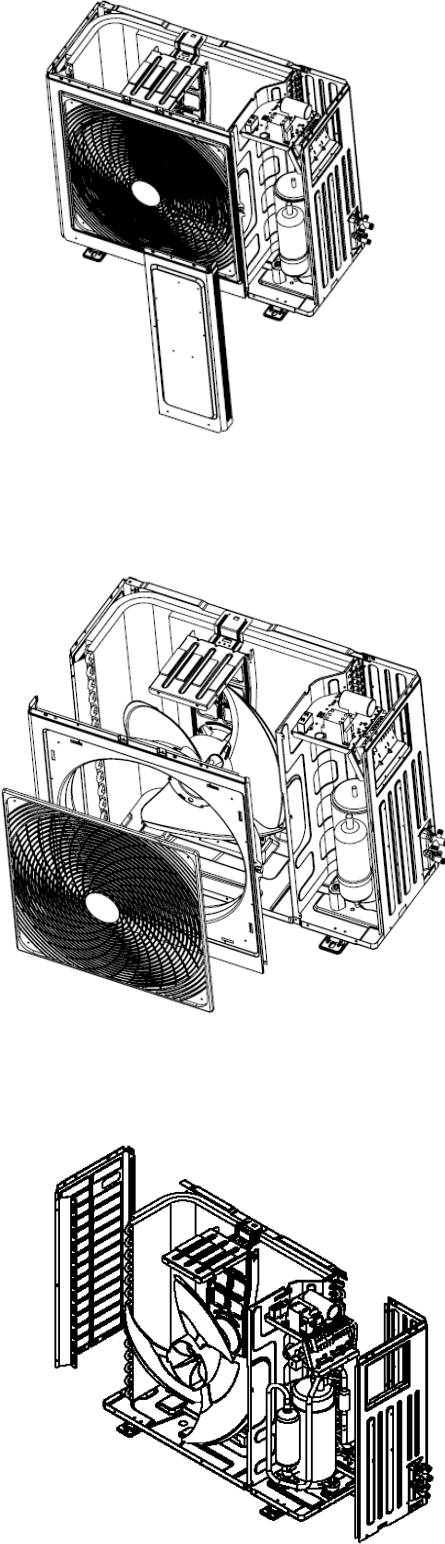
Step		Procedure	Points
2	<p>Loosen the screws of the panel, pull and remove the front panel.</p>		



## 2. Removal of Electrical Box

Procedure



Warning Be sure to wait 10 minutes or more after turning off all power supplies before disassembling work

Step		Procedure	Points
1	Remove the fixing screws, Than lift the electrical box.		



### 3. Removal of Fan and Fan Motor

Procedure

 **Warning** Be sure to wait 10 minutes or more after turning off all power supplies before disassembling work.

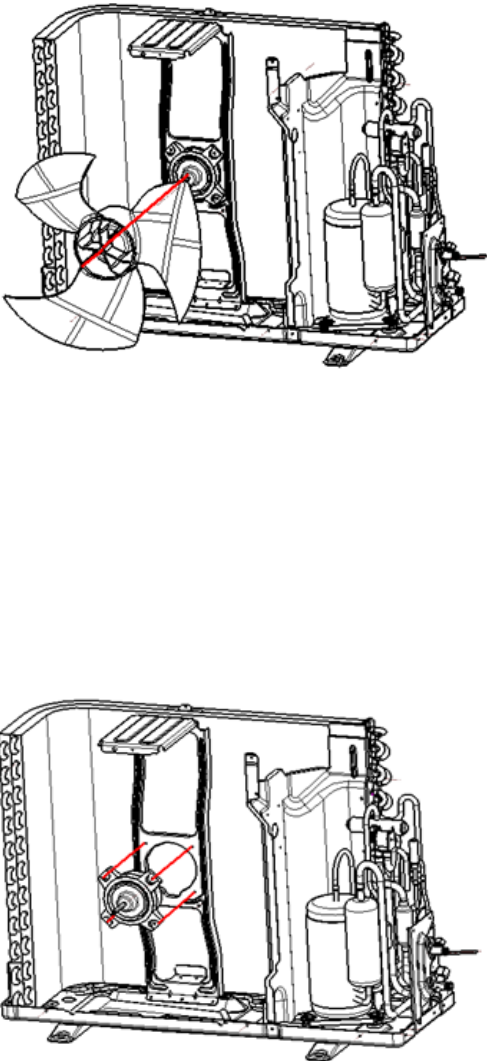
Step	Procedure	Procedure	Points
1	Loosen the fixing screws. Remove the fan and motor.		

## 4. Removal of Fan Motor Bracket and Partition

Procedure

 **Warning** Be sure to wait 10 minutes or more after turning off all power supplies before disassembling work.

Step	Procedure	Points
1	<p>Loosen the fixing screws and lift the fan motor bracket. Remove the partition</p>	

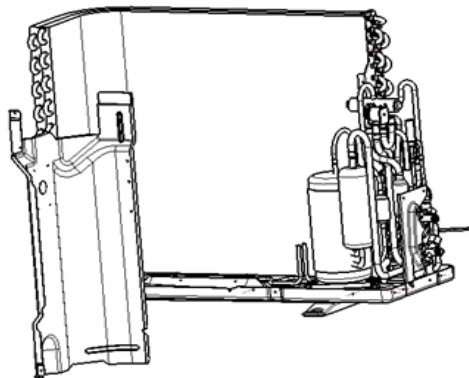
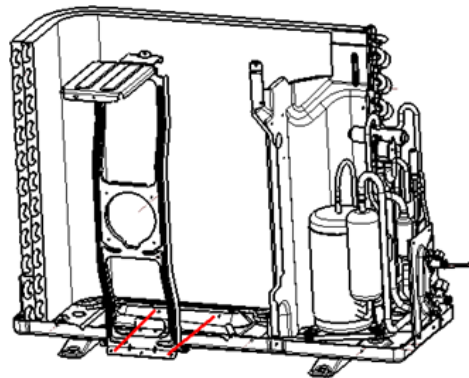

# 5. Removal of Compressor and Heat Exchanger

Procedure



**Warning** Be sure to wait 10 minutes or more after turning off all power supplies before disassembling work.

Step	Procedure	Points
1 Remove the valve plate.		
2 Remove the valves and the compressor.		
3 Loosen the screws and remove the heat exchanger.		