

# Haier SERVICE MANUAL

## Outdoor Unit Model No. 1U68WEGFRA

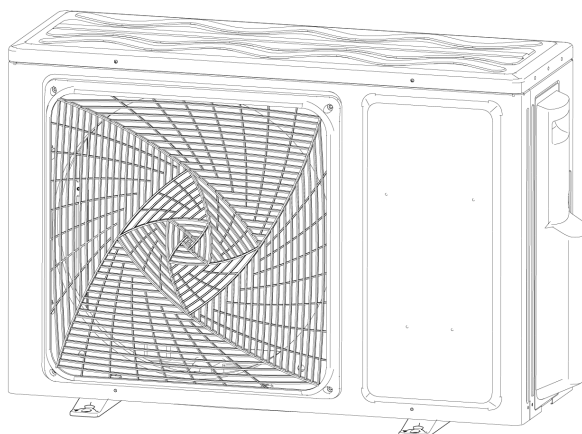

### **WARNING**

This service information is designed for experienced repair technicians only and is not designed for use by the general public. It does not contain warnings or cautions to advise non-technical individuals of potential dangers in attempting to service a product. Products powered by electricity should be serviced or repaired only by experienced professional technicians. Any attempt to service or Repair the product or products dealt with in this service information by anyone else could result in serious injury or death

2021 (Qingdao Haier Air Conditioner General corp. , Ltd)  
All rights reserved. Unauthorized copying and distribution is a violation of law

**Haier Group**

Version: V1

Date: 2021-09-14

## Contents

|  |    |
|--|----|
| 1.Introduction .....                                   | 1  |
| 2.Specifications .....                                 | 7  |
| 3.Sensors list .....                                   | 8  |
| 4.Pinping diagrams .....                               | 9  |
| 5.Operation range .....                                | 10 |
| 6.Printed Circuit Board Connector Wiring Diagram ..... | 11 |
| 7.Outdoor Functions and Control.....                   | 14 |
| 8.Dimensional drawings.....                            | 28 |
| 10.Service Diagnosis .....                             | 29 |
| 11.Performence and cerves diagrams .....               | 44 |
| 12.Sound level .....                                   | 52 |
| 13.Circuit diagrams .....                              | 53 |

# 1.Introduction

## 1.1 Model name explanation

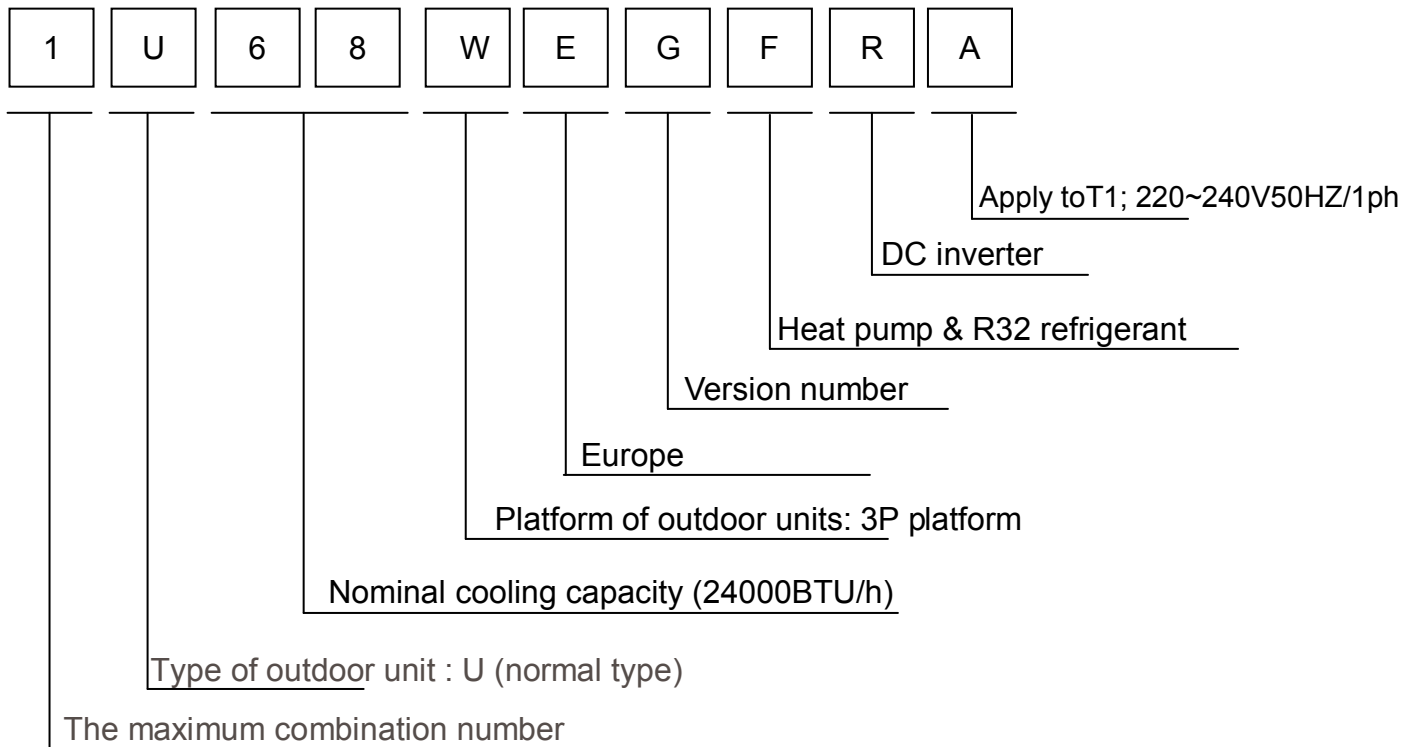

## 1.2 Safety Cautions

Be sure to read the following safety cautions before conducting repair work.

The caution items are classified into “Warning” and “Caution”. The “Warning” items are especially important since they can lead to death or serious injury if they are not followed closely. The “Caution” items can also lead to serious accidents under some conditions if they are not followed. Therefore, be sure to observe all the safety caution items described below.

About the pictograms

△ This symbol indicates an item for which caution must be exercised.

The pictogram shows the item to which attention must be paid.

○ This symbol indicates a prohibited action.

The prohibited item or action is shown inside or near the symbol.

● This symbol indicates an action that must be taken, or an instruction.

The instruction is shown inside or near the symbol.

After the repair work is complete, be sure to conduct a test operation to ensure that the equipment operates Normally, and explain the cautions for operating the product to the customer.

### 1.2.1 Embedded wire checking before installation

Check the embedded wire diameter suitable to request:

(Power supply from indoor: 2.5kw  $\geq 1.0\text{mm}^2$  3.5kw,5kw  $\geq 1.5\text{mm}^2$  7kw  $\geq 2.5\text{mm}^2$  ; Power supply from outdoor  $\geq 1.0\text{mm}^2$  )



Check the embedded wire are four roots, L/N/COM/GND; GND is needed, if not, thunder or high voltage wave from power grid will impact to the performance







Using a multi-meter to test short circuit of the four roots wires, make sure no short circuit happen.



### 1.2.2 Caution in Repair

|  |  |
|--|--|
| <b>Warning</b>   |  |
| <p>Be sure to disconnect the power cable plug from the plug socket before disassembling the equipment for a repair.</p> <p>Working on the equipment that is connected to a power supply can cause an electrical shock.</p> <p>If it is necessary to supply power to the equipment to conduct the repair or inspecting the circuits, do not touch any electrically charged sections of the equipment.</p> |  |
| <p>If the refrigerant gas discharges during the repair work, do not touch the discharging refrigerant gas. The refrigerant gas can cause frostbite.</p>  |  |



|  |   |
|--|---|
| <p>When disconnecting the suction or discharge pipe of the compressor at the welded section, release the refrigerant gas completely at a well-ventilated place first.</p> <p>If there is a gas remaining inside the compressor , the refrigerant gas or refrigerating machine oil discharges when the pipe is disconnected, and it can cause injury.</p> |   |
| <p>If the refrigerant gas leaks during the repair work, ventilate the area. The refrigerant gas can generate toxic gases when it contacts flames.</p>  |  |
| <p>The step-up capacitor supplies high-voltage electricity to the electrical components of the outdoor unit. Be sure to discharge the capacitor completely before conducting repair work . A charged capacitor can cause an electrical shock.</p>  |  |
| <p>Do not start or stop the air conditioner operation by plugging or unplugging the power cable plug. Plugging or unplugging the power cable plug to operate the equipment can cause an electrical shock or fire.</p>  |  |

|   |   |
|---|---|
| <p><b>Warning</b></p>   |   |
| <p>Do not repair the electrical components with wet hands . Working on the equipment with wet hands can cause an electrical shock</p>   |   |
| <p>Do not clean the air conditioner by splashing water. Washing the unit with water can cause an electrical shock.</p>  |  |
| <p>Be sure to provide the grounding when repairing the equipment in a humid or wet place, to avoid electrical shock.</p>  |  |
| <p>Be sure to turn off the power switch and unplug the power cable when cleaning the equipment. The internal fan rotates at a high speed, and cause injury.</p>   |  |
| <p>Do not tilt the unit when removing it. The water inside the unit can spill and wet the furniture and floor.</p>  |  |
| <p>Be sure to check that the refrigerating cycle section has cooled down sufficiently before conducting repair work. Working on the unit when the refrigerating cycle section is hot can cause burns.</p> |   |
| <p>Use the welder in a well-ventilated place. Using the welder in an enclosed room can cause oxygen deficiency.</p>   |  |

1.2.3 Cautions Regarding Products after Repair

|   |  |
|---|--|
| <p><b>Warning</b></p>   |  |
| <p>Be sure to use parts listed in the service parts list of the applicable model and appropriate tools to</p> |  |



|  |                         |
|--|-------------------------|
| <p>conduct repair work. Never attempt to modify the equipment. The use of inappropriate parts or tools can cause an electrical shock, excessive heat generation or fire.</p>   |                         |
| <p>When relocating the equipment, make sure that the new installation site has sufficient strength to withstand the weight of the equipment.<br/>If the installation site does not have sufficient strength and if the installation work is not conducted securely, the equipment can fall and cause injury.</p> |                         |
| <p>Be sure to install the product correctly by using the provided standard installation frame.<br/>Incorrect use of the installation frame and improper installation can cause the equipment to fall, resulting in injury.</p>   | For integral units only |
| <p>Be sure to install the product securely in the installation frame mounted on a window frame.<br/>If the unit is not securely mounted, it can fall and cause injury.</p>   | For integral units only |

|   |   |
|---|---|
| <p><b>Warning</b></p>   |   |
| <p>Be sure to use an exclusive power circuit for the equipment, and follow the technical standards related to the electrical equipment, the internal wiring regulations and the instruction manual for installation when conducting electrical work.<br/>Insufficient power circuit capacity and improper electrical work can cause an electrical shock or fire.</p>                                    |   |
| <p>Be sure to use the specified cable to connect between the indoor and outdoor units. Make the connections securely and route the cable properly so that there is no force pulling the cable at the connection terminals.<br/>Improper connections can cause excessive heat generation or fire.</p>  |   |
| <p>When connecting the cable between the indoor and outdoor units, make sure that the terminal cover does not lift off or dismount because of the cable.<br/>If the cover is not mounted properly, the terminal connection section can cause an electrical shock, excessive heat generation or fire.</p>  |   |
| <p>Do not damage or modify the power cable.<br/>Damaged or modified power cable can cause an electrical shock or fire. Placing heavy items on the power cable, and heating or pulling the power cable can damage the cable.</p>   |  |
| <p>Do not mix air or gas other than the specified refrigerant (R32) in the refrigerant system.<br/>If air enters the refrigerating system, an excessively high pressure results, causing equipment damage and injury.</p>   |   |
| <p>If the refrigerant gas leaks, be sure to locate the leak and repair it before charging the refrigerant. After charging refrigerant, make sure that there is no refrigerant leak.<br/>If the leak cannot be located and the repair work must be stopped, be sure to perform pump-down and close the service valve, to prevent the refrigerant gas from leaking into the room. The refrigerant gas</p> |  |

|   |  |
|---|--|
| <p>itself<br/>is harmless, but it can generate toxic gases when it contacts flames, such as fan and other heaters, stoves and ranges.</p>   |  |
| <p>When replacing the coin battery in the remote controller, be sure to disposed of the old battery to prevent children from swallowing it.<br/>If a child swallows the coin battery, see a doctor immediately.</p> |  |

|  |   |
|--|---|
| <b>Caution</b>   |   |
| <p>Installation of a leakage breaker is necessary in some cases depending on the conditions of the installation site, to prevent electrical shocks.</p>  |   |
| <p>Do not install the equipment in a place where there is a possibility of combustible gas leaks.<br/>If a combustible gas leaks and remains around the unit, it can cause a fire.</p>           |  |
| <p>Be sure to install the packing and seal on the installation frame properly. If the packing and seal are not installed properly, water can enter the room and wet the furniture and floor.</p> |   |

### 1.2.4 Inspection after Repair

|  |   |
|--|---|
| <b>Warning</b>   |   |
| <p>Check to make sure that the power cable plug is not dirty or loose, then insert the plug into a power outlet all the way.<br/>If the plug has dust or loose connection, it can cause an electrical shock or fire.</p> |  |
| <p>If the power cable and lead wires have scratches or deteriorated, be sure to replace them.<br/>Damaged cable and wires can cause an electrical shock, excessive heat generation or fire.</p>                          |  |





|   |   |
|---|---|
| <b>Warning</b>  |   |
| <p>Do not use a joined power cable or extension cable, or share the same power outlet with other electrical appliances since it can cause an electrical shock, excessive heat generation or fire.</p> |  |

|   |   |
|---|---|
| <b>Caution</b>  |   |
| Check to see if the parts and wires are mounted and connected properly, and if the connections at the soldered or crimped terminals are secure. Improper installation and connections can cause excessive heat generation, fire or an electrical shock. |   |
| If the installation platform or frame has corroded, replace it. Corroded installation platform or frame can cause the unit to fall, resulting in injury.  |   |
| Check the grounding, and repair it if the equipment is not properly grounded. Improper grounding can cause an electrical shock.   |  |
| Be sure to measure the insulation resistance after the repair, and make sure that the resistance is 1 M ohm or higher.<br>Faulty insulation can cause an electrical shock.  |   |
| Be sure to check the drainage of the indoor unit after the repair.<br>Faulty drainage can cause the water to enter the room and wet the furniture and floor.  |   |

### 1.2.4 Using Icons

Icons are used to attract the attention of the reader to specific information. The meaning of each icon is described in the table below:

### 1.2.5 Using Icons List

| Icon  | Type of Information | Description  |
|---|---------------------|--|
|  Note      | Note                | A “note” provides information that is not indispensable, but may nevertheless be valuable to the reader, such as tips and tricks.  |
|  Caution   | Caution             | A “caution” is used when there is danger that the reader, through incorrect manipulation, may damage equipment, lose data, get an unexpected result or has to restart (part of) a procedure. |
|  Warning   | Warning             | A “warning” is used when there is danger of personal injury.   |
|  Reference | Reference           | A “reference” guides the reader to other places in this binder or in this manual, where he/she will find additional information on a specific topic.   |



## 2.Specifications

| NOMINAL DISTRIBUTION SYSTEM VOLTAGE |    |         |
|-------------------------------------|----|---------|
| Phase                               | /  | 1       |
| Frequency                           | Hz | 50      |
| Voltage                             | V  | 220-240 |

| NOMINAL CAPACITY and NOMINAL INPUT |                   |                      |                   |
|------------------------------------|-------------------|----------------------|-------------------|
|                                    |                   | Cooling              | heating           |
| Capacity rated                     | kW                | 6.8(2.2-8.5)         | 6.8(2.4-9.5)      |
|                                    | Btu/h             | 23200(7500-29000)    | 23200(8180-32410) |
| Power Consumption(Rated)           | kW                | 2.11                 | 1.83              |
| SEER/SCOP                          | W/W               | 6.8/A++              | 4.0/A+            |
| Annual energy consumption          | kWh               | 350                  | 1960              |
| Moisture Removal                   | m <sup>3</sup> /h | 2.0*10 <sup>-3</sup> |                   |

| TECHNICAL SPECIFICATIONS-UNIT |                |    |              |
|-------------------------------|----------------|----|--------------|
| Dimensions                    | H*W*D          | mm | 890×340×705  |
| Packaged Dimensions           | H*W*D          | mm | 1046×460×780 |
| Weight                        | /              | KG | 44           |
| Gross weight                  | /              | KG | 48           |
| Sound level                   | Sound peessure | dB | 53           |
|                               | Sound power    | dB | 68           |

| ELECTRICAL SPECIFICATIONS |   |         |         |
|---------------------------|---|---------|---------|
|                           |   | Cooling | heating |
| Nominal running current   | A | 9.17    | 7       |
| Maximum running current   | A | 13      | 13      |
| Starting current          | A | 1       | 1       |

| TECHNICAL SPECIFICATIONS-PARTS |                     |                     |         |
|--------------------------------|---------------------|---------------------|---------|
|                                |                     | cooling             | heating |
| Compressor                     | Type                | Rotary Compressor   |         |
|                                | Model               | SVB172FNQMC         |         |
|                                | Motor output        | W                   | 1200    |
|                                | Oil type            | FW68S               |         |
|                                | Oil charge volume   | L                   | 0.35    |
| Fan                            | Type                | Axial fan           |         |
|                                | Motor output        | W                   | 40      |
|                                | Air flow rate(high) | m <sup>3</sup> /h   | 2600    |
|                                | Speed(high/low)     | rpm                 | 950/300 |
| Heat                           | Type                | ML fin-φ7HI-HX tube |         |

|  |  |          |       |
|--|--|----------|-------|
| exchanger                                  | Row*stage*fitch                                      | 2*30*1.4 |       |
| TECHNICAL SPECIFICATIONS-OTHERS            |  |          |       |
| Refrigerant circuit                        | Refrigerant type                                     |          | R32   |
|  | Refrigerant charge                                   | KG       | 1.1   |
|  | Maximum allowable distance between indoor an outdoor | M        | 25    |
|  | Maximum allowable level difference                   | m        | 15    |
|  | Refrigerant control                                  | EEV      |       |
| Piping connections (external diameter)     | liquid   | mm       | Φ6.35 |
|  | gas  | mm       | Φ12.7 |
|  | drain  | mm       | Φ16   |
| Heat insulation type                       | Both liquid and Gas pipes                            |          |       |
| Max. piping Length                         | m  | 25       |       |
| Max. Level Difference                      | m  | 15       |       |
| Chargeless                                 | m  | 7        |       |
| Amount of Additional Charge of Refrigerant | g/m  | 20       |       |

Note: the data are based on the conditions shown in the table below

|   |                                       |               |
|---|---------------------------------------|---------------|
| cooling   | heating                               | Piping length |
| Indoor: 27°CDB/19°CWB<br>Outdoor: 35°CDB/24°CWB | Indoor:20°CDB<br>Outdoor: 7°CDB/6°CWB | 5m            |

|                              |
|------------------------------|
| Conversion formulae          |
| Kcal/h= kW×860               |
| Btu/h= kW×3414               |
| cfm=m <sup>3</sup> /min×35.3 |

### 3.Sensors list

| type               | Description   | Qty |
|--------------------|---|-----|
| Ambient sensor     | Its used for detecting temperature of outdoor side          | 1   |
| Defrosting sensor  | Its used for controlling outdoor defrosting at heating mode |     |
| Descharging sensor | Its used for compressor in case of over-heat                |     |

### 4.Piping diagrams

#### Cooling mode

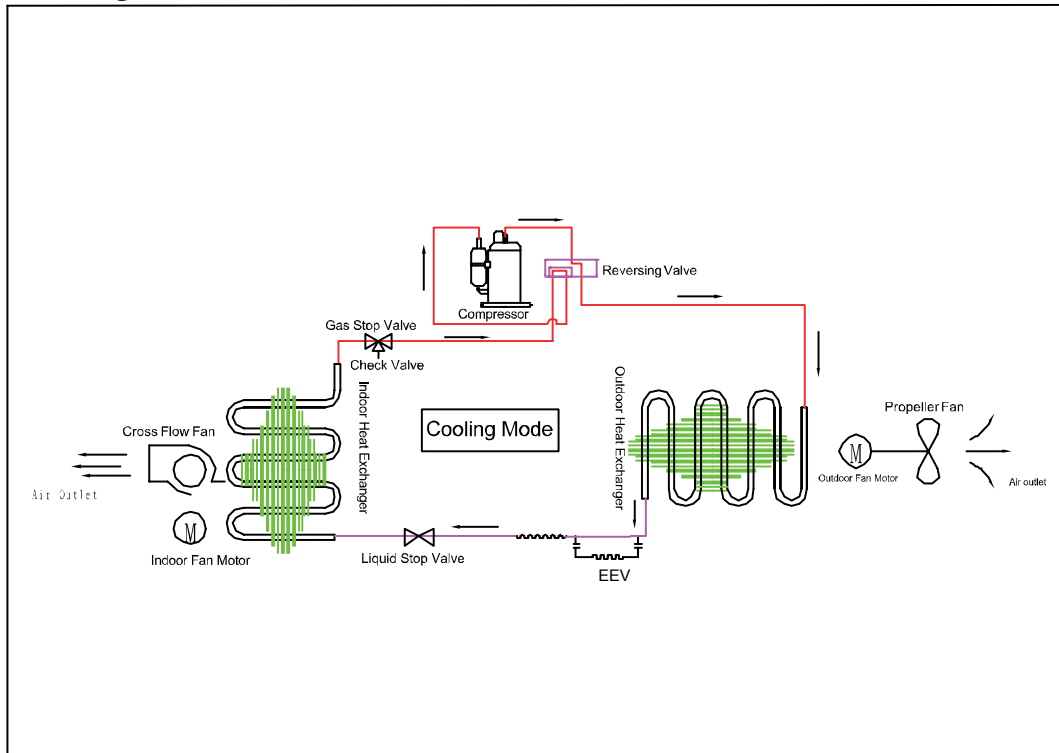

#### Heating mode

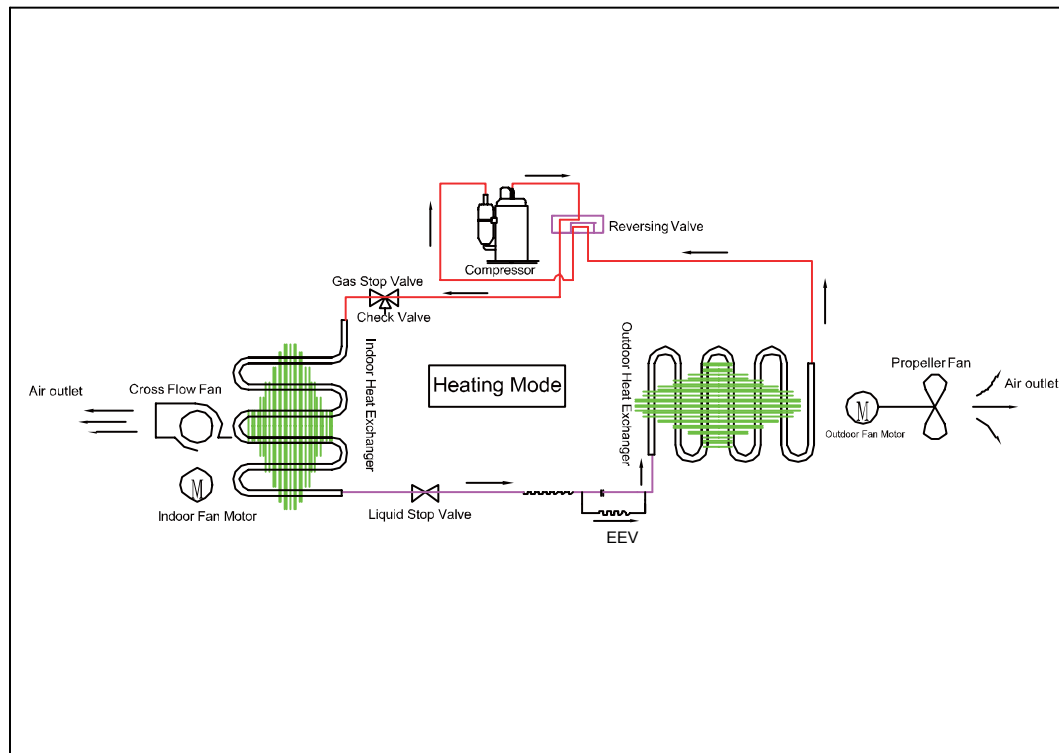

## 5.Operation range

The name of parts

Cooling

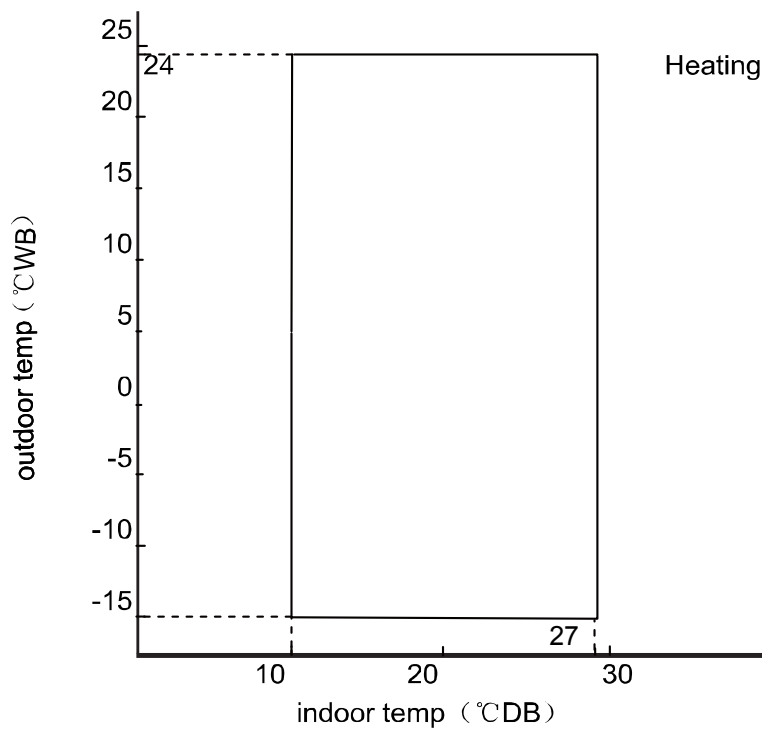
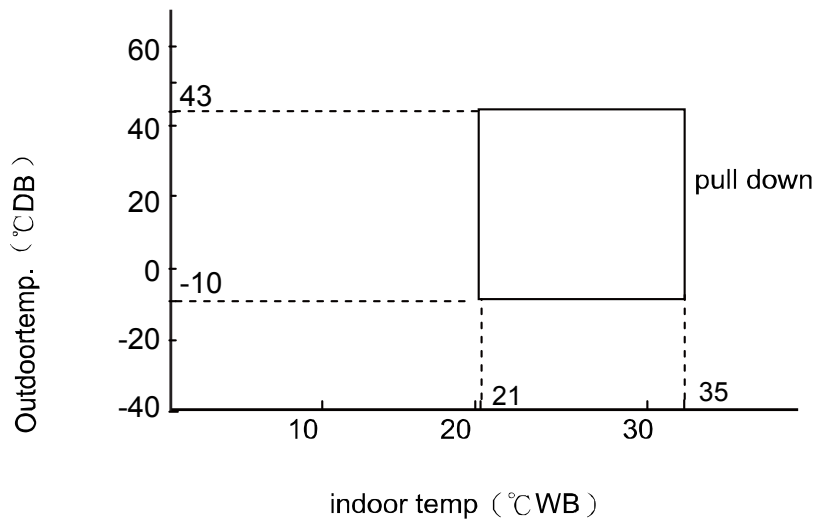

Notes:

The graphs are based on the following condition:

|                          |      |
|--------------------------|------|
| Equivalent piping length | 5m   |
| Level difference         | 0m   |
| Air flow rate            | high |

## 6. Printed Circuit Board Connector Wiring Diagram

### Connectors

#### PCB (1) (Outdoor Control PCB)

|    |             |   |
|----|-------------|---|
| 1  | CN1         | Connector for power N and L                               |
| 2  | CN2         |   |
| 3  | CN3         | Connector for ground                                      |
| 4  | CN7(BLACK)  | Connector for the U, V, W wire of the compressor          |
| 5  | CN8(WHITE)  |   |
| 6  | CN9(RED)    |   |
| 7  | L-IN(CN5)   | Connector for reactor                                     |
| 8  | L-OUT (CN6) |   |
| 9  | CN10        | Connector for fan motor                                   |
| 10 | CN11        | Connector for four way valve coil                         |
| 11 | CN15        | Connector for Temperature sensor                          |
| 12 | CN4         | Connector for communicate between indoor and outdoor unit |
| 13 | CN16        | Connector for electric expansion valves                   |

Note: Other Designations

- 1) FUSE1 1A/250V FUSE2 25A250VAC FUSE3 3.15A/250V
- 2) LED 1 Keep light representative normal, if keep flash interval representative trouble Alarm
- 3) RV1, RV2, RV3, RV4 Varistor

PCB (1)

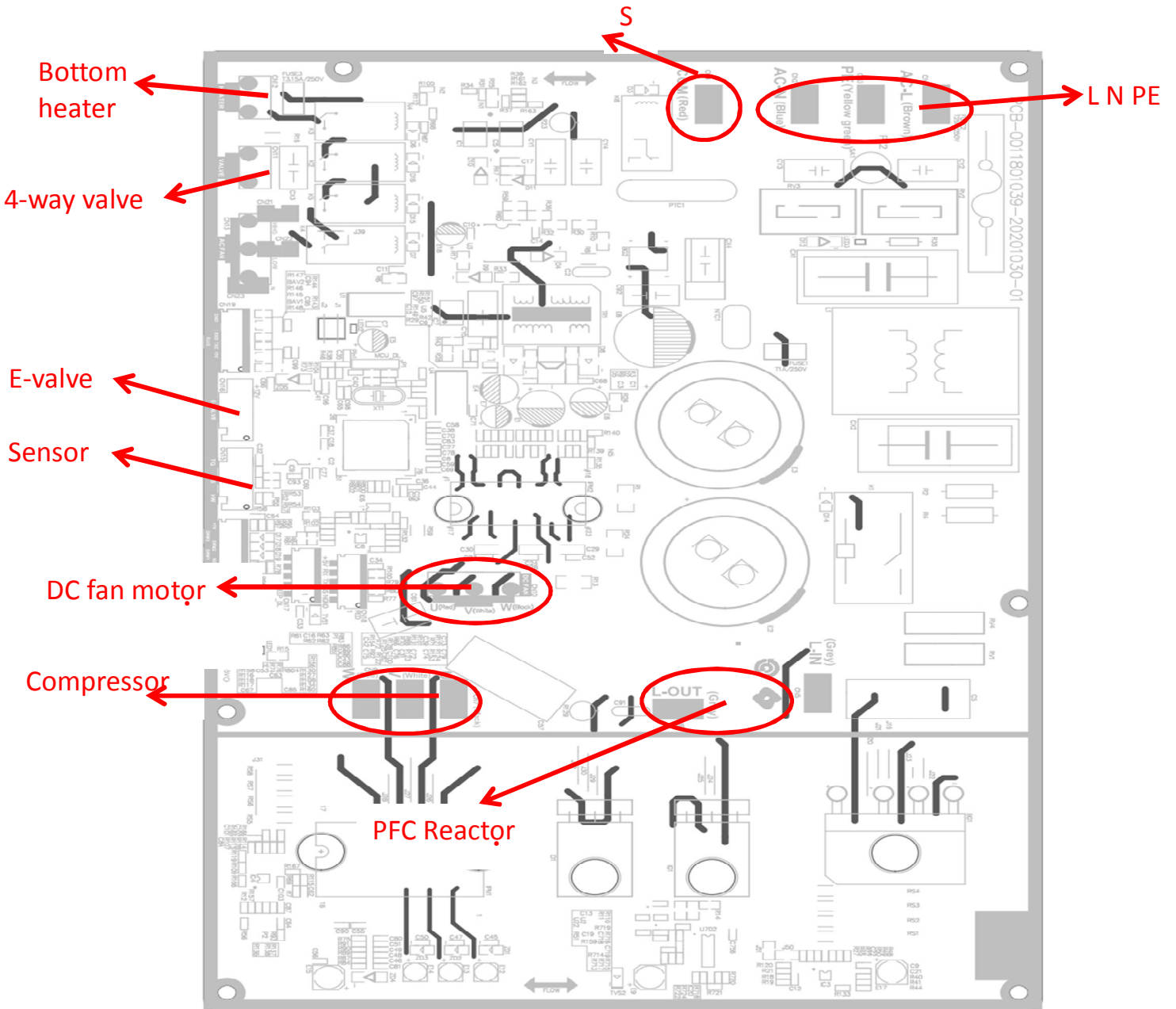

Wiring diagrams

OUTDOOR WIRING DIAGRAM

0011512410

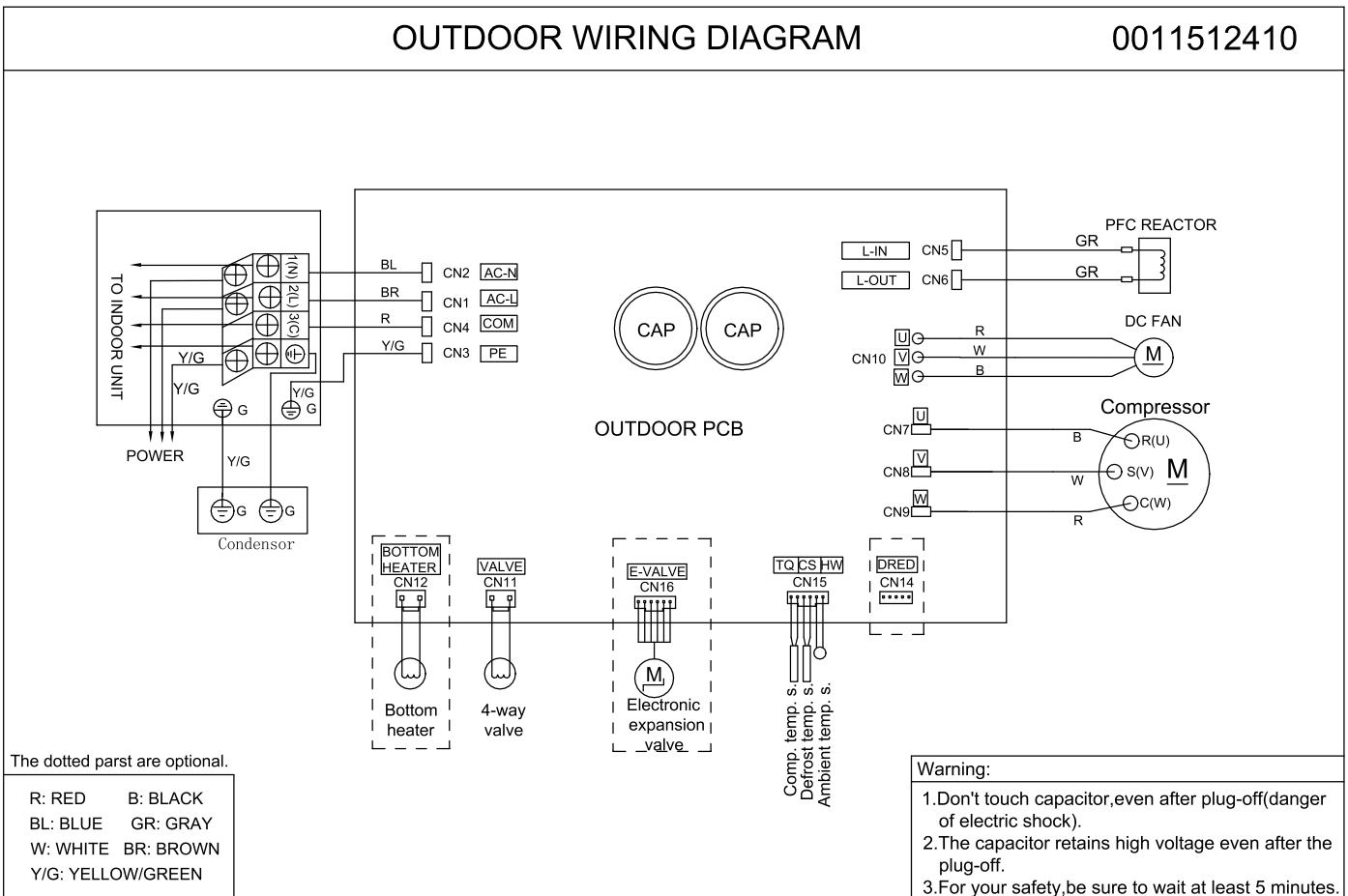

## 7. Outdoor Functions and Control

### 7.1 Main functions and control specification

#### 7.1.1 The operation frequency of outdoor unit and its control

##### 7.1.1.1 The operation frequency control of compressor

The operation frequency scope of compressor:

| Mode          | Minimum operation frequency | Maximum operation frequency |
|---------------|-----------------------------|-----------------------------|
| Heating       | 22Hz                        | 85Hz                        |
| Refrigeration | 22Hz                        | 109Hz                       |

##### 7.1.1.2 The starting of compressor

When the compressor is started for the first time, it must be kept under the conditions of 38Hz, 58Hz, 88Hz for 30second, one minute, one minute (the overheating protection of the outdoor unit air-blowing temperature, immediately decrease the frequency when the compressor is overflowing and releasing the pressure), then it can be operated towards the target frequency. When the machine runs normally, there's no such process. After starting the compressor for operation, the compressor should run according to the calculated frequency, and every determined frequency for protection should be prior to the calculated frequency.

##### 7.1.1.3 The speeds of increasing or decreasing the frequency of the compressor

The speed of increasing or decreasing the frequency rapidly 1 -----1HZ/second

The speed of increasing or decreasing the frequency slowly 2 -----1HZ/10seconds

##### 7.1.1.4 The calculation of the compressor's frequency

Refrigeration/dehumidification mode:

$$P_n = (N_h_c - S_c) * 10 \geq 50 \quad \text{outdoor environment control}$$

$$P_n = (N_h_c - S_c) * 10 < 50 \quad \text{PID control}$$

Heating mode:

$$P_n = (S_c - N_h_c) * 10 \geq 60 \quad \text{outdoor environment control}$$

$$P_n = (S_c - N_h_c) * 10 < 60 \quad \text{PID control}$$

( $N_h_c$ =indoor environment temperature  $S_c$ =setting temperature)

1) The minimum/maximum frequency limitation

A. While refrigerating: F-MAX-r is the maximum operation frequency of the compressor; F-MIN-r is the minimum operation frequency of the compressor.

B. While heating: F-MAX-d is the maximum operation frequency of the compressor; F-MIN-d is the minimum operation frequency of the compressor.

2) The frequency limitation which is affected by the environment temperature.

( $W_h_c$ = environment temperature)

Heating mode:

| Serial No. | Temperature scope | Frequency limitation |
|------------|-------------------|----------------------|
| 1          | $W_h_c < -12$     | Max_hz1 109HZ        |



|   |          |         |       |
|---|----------|---------|-------|
| 2 | Wh_c<-8  | Max_hz2 | 109HZ |
| 3 | Wh_c<-2  | Max_hz3 | 98HZ  |
| 4 | Wh_c<5   | Max_hz4 | 86HZ  |
| 5 | Wh_c<10  | Max_hz5 | 81HZ  |
| 6 | Wh_c<17  | Max_hz6 | 77HZ  |
| 7 | Wh_c<20  | Max_hz7 | 70HZ  |
| 8 | Wh_c>=20 | Max_hz8 | 66HZ  |

Remarks: The above are the maximum frequency limitations of the complete appliance which are affected by the environment, and they have nothing to do with the ability of the indoor unit.

Refrigeration/dehumidification mode:

| Serial No. | Temperature scope | Frequency limitation |
|------------|-------------------|----------------------|
| 1          | Wh_c<16           | Max_hz1 45HZ         |
| 2          | Wh_c<22           | Max_hz2 48HZ         |
| 3          | Wh_c<29           | Max_hz3 62HZ         |
| 4          | Wh_c<32           | Max_hz4 72HZ         |
| 5          | Wh_c<40           | Max_hz5 85HZ         |
| 6          | Wh_c<48           | Max_hz6 68HZ         |
| 7          | Wh_c>=48          | Max_hz7 53HZ         |

Remarks: the above are not only the maximum frequency limitations of the complete appliance which are affected by the environment, but also the maximum ability limitation of the system. When the starting ability is not the maximum, its maximum frequency limitation is calculated by the following equations:

The frequency limitation which is affected by the temperature and under the condition of actual ability = the actual running system ability \* the maximum frequency which is limited by the temperature and under the condition of maximum ability / the maximum designing ability of the system

Refrigeration/dehumidification mode:

|   |     |        |       |
|---|-----|--------|-------|
| The indoor setting airflow speed        | Low | Medium | Quiet |
| The percentage of the rated frequency K | 70% | 85%    | 50%   |

Heating mode:

|   |     |        |       |
|---|-----|--------|-------|
| The indoor setting airflow speed        | Low | Medium | Quiet |
| The percentage of the rated frequency K | 73% | 90%    | 51%   |

The calculation of the actual output frequency:

$$F = F_{-ED} \cdot (\text{rated frequency}) \times K$$

$$F_{-ED} \cdot (\text{rated frequency}) = \text{The frequency which is limited by the outdoor environment temperature}$$

Notes:

When refrigerating, it is needed to satisfy

$$F\text{-MIN-d}(\text{compressor's Min\_hz}) < F < F\text{-MAX-d}(\text{compressor's Max\_hz})$$

When heating, it is needed to satisfy

$$F\text{-MIN-r}(\text{compressor's Min\_hz}) < F < F\text{-MAX-r}(\text{compressor's Max\_hz})$$

PID control :

The initial frequency  $S_n$  is determined by  $P_n$ . We can calculate  $H_z\text{outf}$  according to the value of  $K_p, K_i, K_d, \text{Out\_gain}, P_n$ . Then,  $F_n = S_n + H_z\text{outf}$ . The value of  $F_n$  is calculated in each sample time (60 seconds), and  $F_n$  is adjusted according to previous frequency of  $S_n$  and filtered output of  $H_z\text{outf}$ .

## 7.1.2 The outdoor fan control (Exchange fan)

When the fan is changed among every airflow speed (including stop blowing), in order to avoid the airflow speed from skipping frequently, it must be kept under each mode for over 30 seconds, and then it can be changed to another mode (when refrigerating, the time is changed to 15 seconds).

### 7.1.2.1 The outdoor DC fan control

Within three minutes of compressor starting, the compressor is controlled according to the ambient temperature.

|                                |            |                   |            |
|--------------------------------|------------|-------------------|------------|
| Tao (°C)                       | Tao < 22°C | 22°C < Tao < 29°C | Tao ≥ 29°C |
| Refrigeration/dehumidification | 510rpm     | 610rpm            | 710rpm     |
| Tao (°C)                       | Tao < 10°C | 10°C < Tao < 16°C | Tao ≥ 16°C |
| Heating                        | 710rpm     | 610rpm            | 510rpm     |

After 3 minutes, the compressor is controlled according to the ambient temperature and the frequency of the compressor.

|   |       |         |          |         |
|---|-------|---------|----------|---------|
| Refrigeration/dehumidification frequency (Hz) |       | < 41 Hz | 56 Hz    | ≥ 56 Hz |
| Tao (°C)                                      | ≤ 22  | 510rpm  | 610rpm   | 710rpm  |
|   | 22-29 | 560rpm  | 660rpm   | 750rpm  |
|   | 29-38 | 610rpm  | 710rpm   | 800rpm  |
|   | ≥ 38  | 800rpm  |          |         |
| Heating frequency (Hz)                        |       | < 51 Hz | 51-90 Hz | ≥ 90 Hz |
| Tao (°C)                                      | ≤ 10  | 650rpm  | 700rpm   | 800rpm  |
|   | 10-17 | 460rpm  | 700rpm   | 800rpm  |
|   | ≥ 17  | 460rpm  |          |         |

## 7.1.4 Four way valve control

For the details of defrosting four-way valve control, see the defrosting process.

Four way working in other ways:

Under the mode of heating, open the four-way valve, when the compressor is not started or changed to non-heating mode, make sure the compressor is stopped for 2 minutes, and then close the four-way valve.

## 7.1.5 Protection function

### 7.1.5.1 TTC high temperature-preventing protection

Once the machine is started, it can run TTC(air-blowing temp) overheating protection of air-blowing, but air-blowing sensor malfunction must alarm after 4 minutes during which the compressor is started (during the course of self-detection, there's no such limitation)

Sensor detection methods: 100 times (one cycle of procedure run is one time, and about 5ms, detection method for each time: continuously sampling for 8 times, then order them and take the mean value of the middle 2 values), take the mean value.

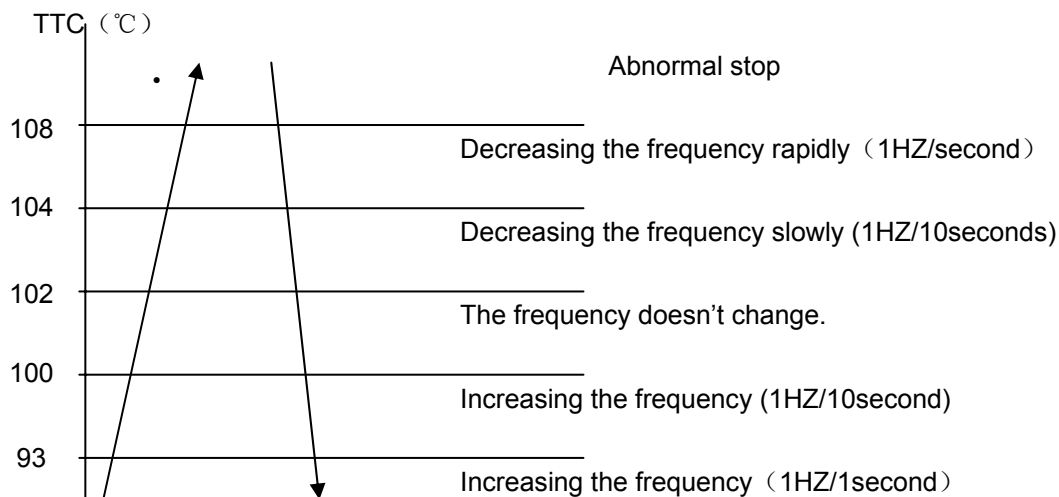

TTC  $\geq$  110°C lasts for 20 seconds. Overheating protection of air-blowing, alarm malfunction to the indoor, others don't last.

### 7.1.5.2 TC high temperature-preventing control of the indoor heating unit:

Tpg\_indoor is the highest value of the effective indoor unit (start it and it is in accord with the running

state). TC=indoor coil temp.

The indoor heat exchanger sensor tests the temperature of the indoor heat exchanger. If the temperature is higher than 63 °C, decrease the rotate speed of the compressor and do the high temperature-preventing protection of the indoor heat exchanger; if the temperature of the indoor heat exchanger is lower than 45 °C, recover to the normal control.

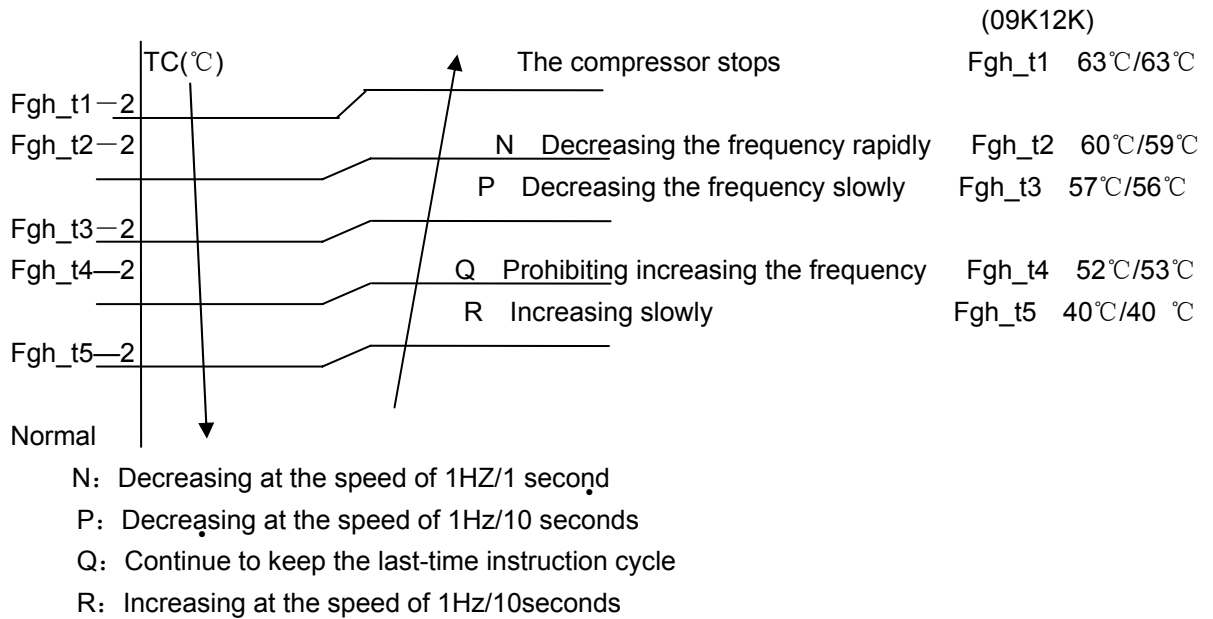

Remarks: the outdoor unit

### 7.1.5.3 The control of preventing the over current of the compressor:

- During the starting process of the compressor, if the current of the compressor is greater than 12.5A for 3 seconds, stop the compressor and alarm, after 3 minutes, start it again, if such state appears 3 times in 20 minutes, stop the compressor and alarm, and confirm the malfunction. Then continue to run it only after the power is off.
- During the starting process of the compressor, if the AC current is greater than 9A, the frequency of the compressor decreases at the speed of 1HZ/second.
- During the starting process of the compressor, if the AC current is greater than 8A, the frequency of the compressor decreases at the speed of 0.1HZ/second.
- During the starting process of the compressor, if the AC current is greater than 7.5A, the frequency of the compressor increases at the prohibited speed.
- During the starting process of the compressor, if the AC current is greater than 6.5A, the frequency of the compressor increases at the speed of no faster than 0.1HZ/second.

### 7.1.5.4 The protection function of AC current:

- During the starting process of the compressor, if the AC current is greater than 12.5A for 3 seconds, stop the compressor and alarm, after 3 minutes, start it again, if such state appears 3 times in 20 minutes, stop the compressor and alarm, and confirm the malfunction. Then continue to run it only after the the power is off.
- During the starting process of the compressor, if the AC current is greater than 9A, the frequency of the compressor decreases at the speed of 1HZ/second.
- During the starting process of the compressor, if the AC current is greater than 8A, the frequency of the compressor decreases at the speed of 0.1HZ/second.
- During the starting process of the compressor, if the AC current is greater than 7.5A, the frequency of

the compressor increases at the prohibited speed.

During the starting process of the compressor, if the AC current is greater than 6.5A, the frequency of the compressor increases at the speed of no faster than 0.1HZ/second.

Remarks: when the outdoor temperature is high, there's compensation for AC current protection.

(1) When the outdoor environment temperature is higher than 40°C, AC current protection value decreases by 2A/1A(09K/12K).

(2) When the outdoor environment temperature is higher than 50°C, AC current protection value decreases by 3A/2A(09K/12K).

#### 7.1.5.5 Anti-freezing protection of the indoor heat exchanger

When refrigerating/heating, prevent freezing.

Tpg\_indoor is the minimum value of the effective indoor unit (start it and it is in accord with the running state).

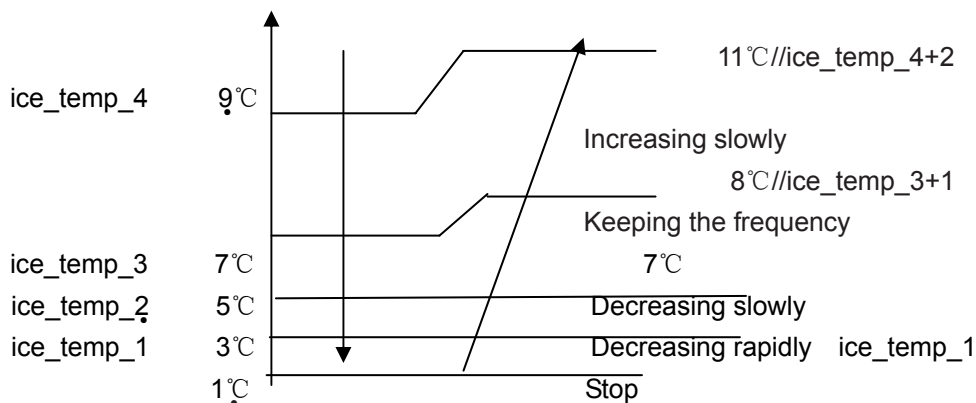

When  $Tpg\_indoor < ice\_temp\_1$ , the frequency of the compressor decreases at the speed of 1HZ/1second.

When  $Tpg\_indoor < ice\_temp\_2$ , the frequency of the compressor decreases at the speed of 1HZ/10seconds.

When Tpg\_indoor begins to rise again, and  $ice\_temp\_2 \leq Tpg\_indoor \leq ice\_temp\_3$ , the frequency of the compressor doesn't change.

When  $ice\_temp\_3 < Tpg\_indoor < ice\_temp\_4$ , the frequency of the compressor increases at the speed of 1HZ/10seconds.

For example,  $Tpg\_indoor \leq 0^\circ\text{C}$ , last for 2 minutes, and then the outdoor unit will stop, and report underload malfunction, but don't send malfunction report to the indoor.

The compressor stops for more than 3 minutes,  $Tpg\_indoor > ice\_temp\_3 + 1^\circ\text{C}$ , the compressor recovers.

#### 7.1.5.6 The frequency limitation of modification rate

In the field which is controlled by high frequency, if the modification rate is not high enough, the control-driven chip will enter into weak magnetic control, this will help to relieve the problem of modification rate. If during the course of weak magnetic control, the modification rate is still not high enough, enter into the control of decreasing frequency until the alarm of modification rate is relieved.

#### 7.1.5.7 Temperature protection of the outdoor refrigerating coil

When the defrosting temperature and the sensor's temperature are higher than 68°C, the frequency of

the compressor decreases 1hz/10seconds. Keep the frequency until it decreases to the lowest frequency.

When the temperatures are lower than 68℃ and higher than 62℃, keep the frequency of the compressor.

When the temperatures are lower than 62℃, relieve the defrosting temperature protection.

## 7.2 Value of Thermistor

### Ambient Sensor, Defrosting Sensor, Pipe sensor

R25℃=10KΩ ±3% B25℃/50℃=3700K±3%

| Temp.(℃) | Max.(KΩ) | Normal(KΩ) | Min.(KΩ) | Tolerance(℃) |      |
|----------|----------|------------|----------|--------------|------|
| -30      | 165.2170 | 147.9497   | 132.3678 | -1.94        | 1.75 |
| -29      | 155.5754 | 139.5600   | 125.0806 | -1.93        | 1.74 |
| -28      | 146.5609 | 131.7022   | 118.2434 | -1.91        | 1.73 |
| -27      | 138.1285 | 124.3392   | 111.8256 | -1.89        | 1.71 |
| -26      | 130.2371 | 117.4366   | 105.7989 | -1.87        | 1.70 |
| -25      | 122.8484 | 110.9627   | 100.1367 | -1.85        | 1.69 |
| -24      | 115.9272 | 104.8882   | 94.8149  | -1.83        | 1.67 |
| -23      | 109.4410 | 99.1858    | 89.8106  | -1.81        | 1.66 |
| -22      | 103.3598 | 93.8305    | 85.1031  | -1.80        | 1.64 |
| -21      | 97.6556  | 88.7989    | 80.6728  | -1.78        | 1.63 |
| -20      | 92.3028  | 84.0695    | 76.5017  | -1.76        | 1.62 |
| -19      | 87.2775  | 79.6222    | 72.5729  | -1.74        | 1.60 |
| -18      | 82.5577  | 75.4384    | 68.8710  | -1.72        | 1.59 |
| -17      | 78.1230  | 71.5010    | 65.3815  | -1.70        | 1.57 |
| -16      | 73.9543  | 67.7939    | 62.0907  | -1.68        | 1.55 |
| -15      | 70.0342  | 64.3023    | 58.9863  | -1.66        | 1.54 |
| -14      | 66.3463  | 61.0123    | 56.0565  | -1.64        | 1.52 |
| -13      | 62.8755  | 57.9110    | 53.2905  | -1.62        | 1.51 |
| -12      | 59.6076  | 54.9866    | 50.6781  | -1.60        | 1.49 |
| -11      | 56.5296  | 52.2278    | 48.2099  | -1.58        | 1.47 |
| -10      | 53.6294  | 49.6244    | 45.8771  | -1.56        | 1.46 |
| -9       | 50.8956  | 47.1666    | 43.6714  | -1.54        | 1.44 |
| -8       | 48.3178  | 44.8454    | 41.5851  | -1.51        | 1.42 |
| -7       | 45.8860  | 42.6525    | 39.6112  | -1.49        | 1.40 |
| -6       | 43.5912  | 40.5800    | 37.7429  | -1.47        | 1.39 |
| -5       | 41.4249  | 38.6207    | 35.9739  | -1.45        | 1.37 |
| -4       | 39.3792  | 36.7676    | 34.2983  | -1.43        | 1.35 |
| -3       | 37.4465  | 35.0144    | 32.7108  | -1.41        | 1.33 |
| -2       | 35.6202  | 33.3552    | 31.2062  | -1.38        | 1.31 |
| -1       | 33.8936  | 31.7844    | 29.7796  | -1.36        | 1.29 |
| 0        | 32.2608  | 30.2968    | 28.4267  | -1.34        | 1.28 |
| 1        | 30.7162  | 28.8875    | 27.1431  | -1.32        | 1.26 |
| 2        | 29.2545  | 27.5519    | 25.9250  | -1.29        | 1.24 |
| 3        | 27.8708  | 26.2858    | 24.7686  | -1.27        | 1.22 |
| 4        | 26.5605  | 25.0851    | 23.6704  | -1.25        | 1.20 |

|    |         |         |         |       |      |
|----|---------|---------|---------|-------|------|
| 5  | 25.3193 | 23.9462 | 22.6273 | -1.23 | 1.18 |
| 6  | 24.1432 | 22.8656 | 21.6361 | -1.20 | 1.16 |
| 7  | 23.0284 | 21.8398 | 20.6939 | -1.18 | 1.14 |
| 8  | 21.9714 | 20.8659 | 19.7982 | -1.15 | 1.12 |
| 9  | 20.9688 | 19.9409 | 18.9463 | -1.13 | 1.09 |
| 10 | 20.0176 | 19.0621 | 18.1358 | -1.11 | 1.07 |
| 11 | 19.1149 | 18.2270 | 17.3646 | -1.08 | 1.05 |
| 12 | 18.2580 | 17.4331 | 16.6305 | -1.06 | 1.03 |
| 13 | 17.4442 | 16.6782 | 15.9315 | -1.03 | 1.01 |
| 14 | 16.6711 | 15.9601 | 15.2657 | -1.01 | 0.99 |
| 15 | 15.9366 | 15.2770 | 14.6315 | -0.98 | 0.96 |
| 16 | 15.2385 | 14.6268 | 14.0271 | -0.96 | 0.94 |
| 17 | 14.5748 | 14.0079 | 13.4510 | -0.93 | 0.92 |
| 18 | 13.9436 | 13.4185 | 12.9017 | -0.91 | 0.90 |
| 19 | 13.3431 | 12.8572 | 12.3778 | -0.88 | 0.87 |
| 20 | 12.7718 | 12.3223 | 11.8780 | -0.86 | 0.85 |
| 21 | 12.2280 | 11.8126 | 11.4011 | -0.83 | 0.83 |
| 22 | 11.7102 | 11.3267 | 10.9459 | -0.81 | 0.80 |
| 23 | 11.2172 | 10.8634 | 10.5114 | -0.78 | 0.78 |
| 24 | 10.7475 | 10.4216 | 10.0964 | -0.75 | 0.75 |
| 25 | 10.3000 | 10.0000 | 9.7000  | -0.75 | 0.75 |
| 26 | 9.8975  | 9.5974  | 9.2980  | -0.76 | 0.76 |
| 27 | 9.5129  | 9.2132  | 8.9148  | -0.80 | 0.80 |
| 28 | 9.1454  | 8.8465  | 8.5496  | -0.84 | 0.83 |
| 29 | 8.7942  | 8.4964  | 8.2013  | -0.87 | 0.86 |
| 30 | 8.4583  | 8.1621  | 7.8691  | -0.91 | 0.90 |
| 31 | 8.1371  | 7.8428  | 7.5522  | -0.95 | 0.93 |
| 32 | 7.8299  | 7.5377  | 7.2498  | -0.98 | 0.97 |
| 33 | 7.5359  | 7.2461  | 6.9611  | -1.02 | 1.00 |
| 34 | 7.2546  | 6.9673  | 6.6854  | -1.06 | 1.04 |
| 35 | 6.9852  | 6.7008  | 6.4222  | -1.10 | 1.07 |
| 36 | 6.7273  | 6.4459  | 6.1707  | -1.13 | 1.11 |
| 37 | 6.4803  | 6.2021  | 5.9304  | -1.17 | 1.14 |
| 38 | 6.2437  | 5.9687  | 5.7007  | -1.21 | 1.18 |
| 39 | 6.0170  | 5.7454  | 5.4812  | -1.25 | 1.22 |
| 40 | 5.7997  | 5.5316  | 5.2712  | -1.29 | 1.25 |
| 41 | 5.5914  | 5.3269  | 5.0704  | -1.33 | 1.29 |
| 42 | 5.3916  | 5.1308  | 4.8783  | -1.37 | 1.33 |
| 43 | 5.2001  | 4.9430  | 4.6944  | -1.41 | 1.36 |
| 44 | 5.0163  | 4.7630  | 4.5185  | -1.45 | 1.40 |
| 45 | 4.8400  | 4.5905  | 4.3500  | -1.49 | 1.44 |
| 46 | 4.6708  | 4.4252  | 4.1887  | -1.53 | 1.47 |
| 47 | 4.5083  | 4.2666  | 4.0342  | -1.57 | 1.51 |
| 48 | 4.3524  | 4.1145  | 3.8862  | -1.61 | 1.55 |

|    |        |        |        |       |      |
|----|--------|--------|--------|-------|------|
| 49 | 4.2026 | 3.9686 | 3.7443 | -1.65 | 1.59 |
| 50 | 4.0588 | 3.8287 | 3.6084 | -1.70 | 1.62 |
| 51 | 3.9206 | 3.6943 | 3.4780 | -1.74 | 1.66 |
| 52 | 3.7878 | 3.5654 | 3.3531 | -1.78 | 1.70 |
| 53 | 3.6601 | 3.4416 | 3.2332 | -1.82 | 1.74 |
| 54 | 3.5374 | 3.3227 | 3.1183 | -1.87 | 1.78 |
| 55 | 3.4195 | 3.2085 | 3.0079 | -1.91 | 1.82 |
| 56 | 3.3060 | 3.0989 | 2.9021 | -1.95 | 1.85 |
| 57 | 3.1969 | 2.9935 | 2.8005 | -2.00 | 1.89 |
| 58 | 3.0919 | 2.8922 | 2.7029 | -2.04 | 1.93 |
| 59 | 2.9909 | 2.7948 | 2.6092 | -2.08 | 1.97 |
| 60 | 2.8936 | 2.7012 | 2.5193 | -2.13 | 2.01 |
| 61 | 2.8000 | 2.6112 | 2.4328 | -2.17 | 2.05 |
| 62 | 2.7099 | 2.5246 | 2.3498 | -2.22 | 2.09 |
| 63 | 2.6232 | 2.4413 | 2.2700 | -2.26 | 2.13 |
| 64 | 2.5396 | 2.3611 | 2.1932 | -2.31 | 2.17 |
| 65 | 2.4591 | 2.2840 | 2.1195 | -2.36 | 2.21 |
| 66 | 2.3815 | 2.2098 | 2.0486 | -2.40 | 2.25 |
| 67 | 2.3068 | 2.1383 | 1.9803 | -2.45 | 2.29 |
| 68 | 2.2347 | 2.0695 | 1.9147 | -2.49 | 2.34 |
| 69 | 2.1652 | 2.0032 | 1.8516 | -2.54 | 2.38 |
| 70 | 2.0983 | 1.9393 | 1.7908 | -2.59 | 2.42 |
| 71 | 2.0337 | 1.8778 | 1.7324 | -2.63 | 2.46 |
| 72 | 1.9714 | 1.8186 | 1.6761 | -2.68 | 2.50 |
| 73 | 1.9113 | 1.7614 | 1.6219 | -2.73 | 2.54 |
| 74 | 1.8533 | 1.7064 | 1.5697 | -2.78 | 2.58 |
| 75 | 1.7974 | 1.6533 | 1.5194 | -2.83 | 2.63 |
| 76 | 1.7434 | 1.6021 | 1.4710 | -2.88 | 2.67 |
| 77 | 1.6913 | 1.5528 | 1.4243 | -2.92 | 2.71 |
| 78 | 1.6409 | 1.5051 | 1.3794 | -2.97 | 2.75 |
| 79 | 1.5923 | 1.4592 | 1.3360 | -3.02 | 2.80 |
| 80 | 1.5454 | 1.4149 | 1.2942 | -3.07 | 2.84 |
| 81 | 1.5000 | 1.3721 | 1.2540 | -3.12 | 2.88 |
| 82 | 1.4562 | 1.3308 | 1.2151 | -3.17 | 2.93 |
| 83 | 1.4139 | 1.2910 | 1.1776 | -3.22 | 2.97 |
| 84 | 1.3730 | 1.2525 | 1.1415 | -3.27 | 3.01 |
| 85 | 1.3335 | 1.2153 | 1.1066 | -3.32 | 3.06 |
| 86 | 1.2953 | 1.1794 | 1.0730 | -3.38 | 3.10 |
| 87 | 1.2583 | 1.1448 | 1.0405 | -3.43 | 3.15 |
| 88 | 1.2226 | 1.1113 | 1.0092 | -3.48 | 3.19 |
| 89 | 1.1880 | 1.0789 | 0.9789 | -3.53 | 3.24 |
| 90 | 1.1546 | 1.0476 | 0.9497 | -3.58 | 3.28 |
| 91 | 1.1223 | 1.0174 | 0.9215 | -3.64 | 3.33 |
| 92 | 1.0910 | 0.9882 | 0.8942 | -3.69 | 3.37 |



|     |        |        |        |       |      |
|-----|--------|--------|--------|-------|------|
| 93  | 1.0607 | 0.9599 | 0.8679 | -3.74 | 3.42 |
| 94  | 1.0314 | 0.9326 | 0.8424 | -3.80 | 3.46 |
| 95  | 1.0030 | 0.9061 | 0.8179 | -3.85 | 3.51 |
| 96  | 0.9756 | 0.8806 | 0.7941 | -3.90 | 3.55 |
| 97  | 0.9490 | 0.8558 | 0.7711 | -3.96 | 3.60 |
| 98  | 0.9232 | 0.8319 | 0.7489 | -4.01 | 3.64 |
| 99  | 0.8983 | 0.8088 | 0.7275 | -4.07 | 3.69 |
| 100 | 0.8741 | 0.7863 | 0.7067 | -4.12 | 3.74 |
| 101 | 0.8507 | 0.7646 | 0.6867 | -4.18 | 3.78 |
| 102 | 0.8281 | 0.7436 | 0.6672 | -4.23 | 3.83 |
| 103 | 0.8061 | 0.7233 | 0.6484 | -4.29 | 3.88 |
| 104 | 0.7848 | 0.7036 | 0.6303 | -4.34 | 3.92 |
| 105 | 0.7641 | 0.6845 | 0.6127 | -4.40 | 3.97 |
| 106 | 0.7441 | 0.6661 | 0.5957 | -4.46 | 4.02 |
| 107 | 0.7247 | 0.6482 | 0.5792 | -4.51 | 4.07 |
| 108 | 0.7059 | 0.6308 | 0.5632 | -4.57 | 4.12 |
| 109 | 0.6877 | 0.6140 | 0.5478 | -4.63 | 4.16 |
| 110 | 0.6700 | 0.5977 | 0.5328 | -4.69 | 4.21 |
| 111 | 0.6528 | 0.5820 | 0.5183 | -4.74 | 4.26 |
| 112 | 0.6361 | 0.5667 | 0.5043 | -4.80 | 4.31 |
| 113 | 0.6200 | 0.5518 | 0.4907 | -4.86 | 4.36 |
| 114 | 0.6043 | 0.5374 | 0.4775 | -4.92 | 4.41 |
| 115 | 0.5891 | 0.5235 | 0.4648 | -4.98 | 4.45 |
| 116 | 0.5743 | 0.5100 | 0.4524 | -5.04 | 4.50 |
| 117 | 0.5600 | 0.4968 | 0.4404 | -5.10 | 4.55 |
| 118 | 0.5460 | 0.4841 | 0.4288 | -5.16 | 4.60 |
| 119 | 0.5325 | 0.4717 | 0.4175 | -5.22 | 4.65 |
| 120 | 0.5194 | 0.4597 | 0.4066 | -5.28 | 4.70 |

## Discharging Sensor

R80°C=50KΩ ± 3%

B25/80°C=4450K ± 3%

| Temp.(°C) | Max.(KΩ)   | Normal(KΩ) | Min.(KΩ)  | Tolerance(°C) |      |
|-----------|------------|------------|-----------|---------------|------|
| -30       | 14646.0505 | 12061.7438 | 9924.4999 | -2.96         | 2.45 |
| -29       | 13654.1707 | 11267.8730 | 9290.2526 | -2.95         | 2.44 |
| -28       | 12735.8378 | 10531.3695 | 8700.6388 | -2.93         | 2.44 |
| -27       | 11885.1336 | 9847.7240  | 8152.2338 | -2.92         | 2.43 |
| -26       | 11096.6531 | 9212.8101  | 7641.8972 | -2.91         | 2.42 |
| -25       | 10365.4565 | 8622.8491  | 7166.7474 | -2.90         | 2.42 |
| -24       | 9687.0270  | 8074.3787  | 6724.1389 | -2.88         | 2.41 |
| -23       | 9057.2314  | 7564.2244  | 6311.6413 | -2.87         | 2.41 |
| -22       | 8472.2852  | 7089.4741  | 5927.0206 | -2.86         | 2.40 |

|     |           |           |           |       |      |
|-----|-----------|-----------|-----------|-------|------|
| -21 | 7928.7217 | 6647.4547 | 5568.2222 | -2.84 | 2.39 |
| -20 | 7423.3626 | 6235.7109 | 5233.3554 | -2.83 | 2.39 |
| -19 | 6953.2930 | 5851.9864 | 4920.6791 | -2.82 | 2.38 |
| -18 | 6515.8375 | 5494.2064 | 4628.5894 | -2.80 | 2.37 |
| -17 | 6108.5393 | 5160.4621 | 4355.6078 | -2.79 | 2.37 |
| -16 | 5729.1413 | 4848.9963 | 4100.3708 | -2.77 | 2.36 |
| -15 | 5375.5683 | 4558.1906 | 3861.6201 | -2.76 | 2.35 |
| -14 | 5045.9114 | 4286.5535 | 3638.1938 | -2.75 | 2.34 |
| -13 | 4738.4141 | 4032.7098 | 3429.0191 | -2.73 | 2.34 |
| -12 | 4451.4586 | 3795.3910 | 3233.1039 | -2.72 | 2.33 |
| -11 | 4183.5548 | 3573.4260 | 3049.5312 | -2.70 | 2.32 |
| -10 | 3933.3289 | 3365.7336 | 2877.4527 | -2.69 | 2.31 |
| -9  | 3699.5139 | 3171.3148 | 2716.0828 | -2.67 | 2.30 |
| -8  | 3480.9407 | 2989.2460 | 2564.6945 | -2.66 | 2.29 |
| -7  | 3276.5302 | 2818.6731 | 2422.6139 | -2.64 | 2.28 |
| -6  | 3085.2854 | 2658.8058 | 2289.2164 | -2.63 | 2.28 |
| -5  | 2906.2851 | 2508.9126 | 2163.9230 | -2.61 | 2.27 |
| -4  | 2738.6777 | 2368.3158 | 2046.1961 | -2.60 | 2.26 |
| -3  | 2581.6752 | 2236.3876 | 1935.5371 | -2.58 | 2.25 |
| -2  | 2434.5487 | 2112.5459 | 1831.4826 | -2.56 | 2.24 |
| -1  | 2296.6230 | 1996.2509 | 1733.6024 | -2.55 | 2.23 |
| 0   | 2167.2730 | 1887.0018 | 1641.4966 | -2.53 | 2.22 |
| 1   | 2045.9191 | 1784.3336 | 1554.7931 | -2.52 | 2.21 |
| 2   | 1932.0242 | 1687.8144 | 1473.1460 | -2.50 | 2.20 |
| 3   | 1825.0899 | 1597.0431 | 1396.2333 | -2.48 | 2.19 |
| 4   | 1724.6540 | 1511.6468 | 1323.7551 | -2.47 | 2.17 |
| 5   | 1630.2870 | 1431.2787 | 1255.4324 | -2.45 | 2.16 |
| 6   | 1541.5904 | 1355.6163 | 1191.0048 | -2.43 | 2.15 |
| 7   | 1458.1938 | 1284.3593 | 1130.2298 | -2.41 | 2.14 |
| 8   | 1379.7528 | 1217.2282 | 1072.8813 | -2.40 | 2.13 |
| 9   | 1305.9472 | 1153.9626 | 1018.7481 | -2.38 | 2.12 |
| 10  | 1236.4792 | 1094.3200 | 967.6334  | -2.36 | 2.11 |
| 11  | 1171.0715 | 1038.0743 | 919.3533  | -2.35 | 2.09 |
| 12  | 1109.4661 | 985.0146  | 873.7359  | -2.33 | 2.08 |
| 13  | 1051.4226 | 934.9440  | 830.6210  | -2.31 | 2.07 |
| 14  | 996.7169  | 887.6792  | 789.8583  | -2.29 | 2.06 |
| 15  | 945.1404  | 843.0486  | 751.3077  | -2.27 | 2.04 |
| 16  | 896.4981  | 800.8922  | 714.8380  | -2.26 | 2.03 |
| 17  | 850.6086  | 761.0603  | 680.3265  | -2.24 | 2.02 |
| 18  | 807.3024  | 723.4134  | 647.6580  | -2.22 | 2.00 |
| 19  | 766.4212  | 687.8205  | 616.7252  | -2.20 | 1.99 |
| 20  | 727.8172  | 654.1596  | 587.4271  | -2.18 | 1.98 |
| 21  | 691.3524  | 622.3161  | 559.6694  | -2.16 | 1.96 |
| 22  | 656.8979  | 592.1831  | 533.3634  | -2.14 | 1.95 |

|    |          |          |          |       |      |
|----|----------|----------|----------|-------|------|
| 23 | 624.3328 | 563.6604 | 508.4261 | -2.12 | 1.93 |
| 24 | 593.5446 | 536.6540 | 484.7796 | -2.10 | 1.92 |
| 25 | 564.4275 | 511.0760 | 462.3510 | -2.09 | 1.90 |
| 26 | 536.9865 | 486.9352 | 441.1516 | -2.07 | 1.89 |
| 27 | 511.0105 | 464.0500 | 421.0258 | -2.05 | 1.87 |
| 28 | 486.4151 | 442.3499 | 401.9146 | -2.03 | 1.86 |
| 29 | 463.1208 | 421.7683 | 383.7626 | -2.01 | 1.84 |
| 30 | 441.0535 | 402.2430 | 366.5175 | -1.99 | 1.83 |
| 31 | 420.1431 | 383.7151 | 350.1301 | -1.97 | 1.81 |
| 32 | 400.3242 | 366.1295 | 334.5542 | -1.95 | 1.80 |
| 33 | 381.5350 | 349.4341 | 319.7460 | -1.93 | 1.78 |
| 34 | 363.7176 | 333.5801 | 305.6645 | -1.90 | 1.76 |
| 35 | 346.8176 | 318.5216 | 292.2709 | -1.88 | 1.75 |
| 36 | 330.7839 | 304.2151 | 279.5286 | -1.86 | 1.73 |
| 37 | 315.5682 | 290.6199 | 267.4031 | -1.84 | 1.71 |
| 38 | 301.1254 | 277.6976 | 255.8620 | -1.82 | 1.70 |
| 39 | 287.4128 | 265.4119 | 244.8745 | -1.80 | 1.68 |
| 40 | 274.3905 | 253.7288 | 234.4118 | -1.78 | 1.66 |
| 41 | 262.0206 | 242.6161 | 224.4465 | -1.76 | 1.64 |
| 42 | 250.2676 | 232.0436 | 214.9529 | -1.74 | 1.63 |
| 43 | 239.0983 | 221.9825 | 205.9065 | -1.71 | 1.61 |
| 44 | 228.4809 | 212.4060 | 197.2844 | -1.69 | 1.59 |
| 45 | 218.3860 | 203.2887 | 189.0648 | -1.67 | 1.57 |
| 46 | 208.7855 | 194.6066 | 181.2273 | -1.65 | 1.55 |
| 47 | 199.6531 | 186.3369 | 173.7524 | -1.63 | 1.54 |
| 48 | 190.9639 | 178.4584 | 166.6217 | -1.60 | 1.52 |
| 49 | 182.6945 | 170.9508 | 159.8181 | -1.58 | 1.50 |
| 50 | 174.8228 | 163.7951 | 153.3249 | -1.56 | 1.48 |
| 51 | 167.3280 | 156.9733 | 147.1268 | -1.53 | 1.46 |
| 52 | 160.1904 | 150.4683 | 141.2090 | -1.51 | 1.44 |
| 53 | 153.3914 | 144.2641 | 135.5577 | -1.49 | 1.42 |
| 54 | 146.9136 | 138.3454 | 130.1598 | -1.47 | 1.40 |
| 55 | 140.7403 | 132.6980 | 125.0027 | -1.44 | 1.38 |
| 56 | 134.8559 | 127.3081 | 120.0746 | -1.42 | 1.36 |
| 57 | 129.2457 | 122.1630 | 115.3645 | -1.40 | 1.34 |
| 58 | 123.8956 | 117.2504 | 110.8618 | -1.37 | 1.32 |
| 59 | 118.7926 | 112.5589 | 106.5564 | -1.35 | 1.30 |
| 60 | 113.9241 | 108.0776 | 102.4388 | -1.32 | 1.28 |
| 61 | 109.2784 | 103.7961 | 98.5000  | -1.30 | 1.26 |
| 62 | 104.8443 | 99.7046  | 94.7315  | -1.28 | 1.23 |
| 63 | 100.6112 | 95.7939  | 91.1253  | -1.25 | 1.21 |
| 64 | 96.5692  | 92.0553  | 87.6735  | -1.23 | 1.19 |
| 65 | 92.7088  | 88.4805  | 84.3690  | -1.20 | 1.17 |
| 66 | 89.0211  | 85.0614  | 81.2048  | -1.18 | 1.15 |

|     |         |         |         |       |      |
|-----|---------|---------|---------|-------|------|
| 67  | 85.4976 | 81.7908 | 78.1744 | -1.15 | 1.12 |
| 68  | 82.1303 | 78.6615 | 75.2715 | -1.13 | 1.10 |
| 69  | 78.9116 | 75.6668 | 72.4902 | -1.10 | 1.08 |
| 70  | 75.8343 | 72.8004 | 69.8249 | -1.08 | 1.06 |
| 71  | 72.8916 | 70.0561 | 67.2703 | -1.05 | 1.03 |
| 72  | 70.0770 | 67.4283 | 64.8213 | -1.03 | 1.01 |
| 73  | 67.3844 | 64.9115 | 62.4731 | -1.00 | 0.99 |
| 74  | 64.8080 | 62.5006 | 60.2211 | -0.98 | 0.96 |
| 75  | 62.3423 | 60.1906 | 58.0609 | -0.95 | 0.94 |
| 76  | 59.9821 | 57.9770 | 55.9885 | -0.92 | 0.92 |
| 77  | 57.7223 | 55.8552 | 53.9998 | -0.90 | 0.89 |
| 78  | 55.5583 | 53.8210 | 52.0912 | -0.87 | 0.87 |
| 79  | 53.4856 | 51.8706 | 50.2591 | -0.85 | 0.84 |
| 80  | 51.5000 | 50.0000 | 48.5000 | -0.85 | 0.84 |
| 81  | 49.7063 | 48.2057 | 46.7083 | -0.85 | 0.85 |
| 82  | 47.9835 | 46.4842 | 44.9911 | -0.89 | 0.89 |
| 83  | 46.3286 | 44.8323 | 43.3452 | -0.93 | 0.92 |
| 84  | 44.7385 | 43.2468 | 41.7672 | -0.96 | 0.95 |
| 85  | 43.2105 | 41.7248 | 40.2540 | -1.00 | 0.99 |
| 86  | 41.7386 | 40.2604 | 38.7996 | -1.03 | 1.02 |
| 87  | 40.3241 | 38.8545 | 37.4048 | -1.07 | 1.06 |
| 88  | 38.9643 | 37.5045 | 36.0668 | -1.11 | 1.09 |
| 89  | 37.6569 | 36.2078 | 34.7831 | -1.14 | 1.13 |
| 90  | 36.3996 | 34.9622 | 33.5513 | -1.18 | 1.16 |
| 91  | 35.1903 | 33.7653 | 32.3689 | -1.22 | 1.19 |
| 92  | 34.0269 | 32.6151 | 31.2338 | -1.26 | 1.23 |
| 93  | 32.9075 | 31.5096 | 30.1438 | -1.30 | 1.27 |
| 94  | 31.8302 | 30.4467 | 29.0970 | -1.33 | 1.30 |
| 95  | 30.7933 | 29.4246 | 28.0915 | -1.37 | 1.34 |
| 96  | 29.7950 | 28.4417 | 27.1254 | -1.41 | 1.37 |
| 97  | 28.8337 | 27.4961 | 26.1970 | -1.45 | 1.41 |
| 98  | 27.9078 | 26.5864 | 25.3048 | -1.49 | 1.44 |
| 99  | 27.0160 | 25.7110 | 24.4470 | -1.53 | 1.48 |
| 100 | 26.1569 | 24.8685 | 23.6222 | -1.57 | 1.52 |
| 101 | 25.3290 | 24.0574 | 22.8291 | -1.61 | 1.55 |
| 102 | 24.5311 | 23.2765 | 22.0662 | -1.65 | 1.59 |
| 103 | 23.7620 | 22.5245 | 21.3323 | -1.69 | 1.63 |
| 104 | 23.0205 | 21.8002 | 20.6261 | -1.73 | 1.66 |
| 105 | 22.3055 | 21.1025 | 19.9465 | -1.77 | 1.70 |
| 106 | 21.6159 | 20.4303 | 19.2924 | -1.81 | 1.74 |
| 107 | 20.9508 | 19.7825 | 18.6626 | -1.85 | 1.77 |
| 108 | 20.3091 | 19.1582 | 18.0563 | -1.89 | 1.81 |
| 109 | 19.6899 | 18.5564 | 17.4723 | -1.93 | 1.85 |
| 110 | 19.0924 | 17.9761 | 16.9098 | -1.98 | 1.89 |

|     |         |         |         |       |      |
|-----|---------|---------|---------|-------|------|
| 111 | 18.5157 | 17.4166 | 16.3680 | -2.02 | 1.93 |
| 112 | 17.9590 | 16.8769 | 15.8458 | -2.06 | 1.96 |
| 113 | 17.4214 | 16.3564 | 15.3427 | -2.10 | 2.00 |
| 114 | 16.9023 | 15.8542 | 14.8577 | -2.15 | 2.04 |
| 115 | 16.4010 | 15.3696 | 14.3902 | -2.19 | 2.08 |
| 116 | 15.9167 | 14.9020 | 13.9394 | -2.23 | 2.12 |
| 117 | 15.4489 | 14.4506 | 13.5047 | -2.27 | 2.16 |
| 118 | 14.9968 | 14.0149 | 13.0855 | -2.32 | 2.19 |
| 119 | 14.5599 | 13.5942 | 12.6811 | -2.36 | 2.23 |
| 120 | 14.1376 | 13.1879 | 12.2909 | -2.41 | 2.27 |
| 121 | 13.7294 | 12.7955 | 11.9144 | -2.45 | 2.31 |
| 122 | 13.3347 | 12.4165 | 11.5510 | -2.50 | 2.35 |
| 123 | 12.9531 | 12.0503 | 11.2003 | -2.54 | 2.39 |
| 124 | 12.5840 | 11.6965 | 10.8617 | -2.58 | 2.43 |
| 125 | 12.2270 | 11.3545 | 10.5348 | -2.63 | 2.47 |
| 126 | 11.8817 | 11.0240 | 10.2191 | -2.68 | 2.51 |
| 127 | 11.5475 | 10.7046 | 9.9142  | -2.72 | 2.55 |
| 128 | 11.2242 | 10.3957 | 9.6197  | -2.77 | 2.59 |
| 129 | 10.9112 | 10.0970 | 9.3352  | -2.81 | 2.63 |
| 130 | 10.6084 | 9.8082  | 9.0602  | -2.86 | 2.67 |
| 131 | 10.3151 | 9.5288  | 8.7945  | -2.91 | 2.71 |
| 132 | 10.0312 | 9.2586  | 8.5378  | -2.95 | 2.75 |
| 133 | 9.7563  | 8.9971  | 8.2895  | -3.00 | 2.80 |
| 134 | 9.4901  | 8.7441  | 8.0495  | -3.05 | 2.84 |
| 135 | 9.2322  | 8.4993  | 7.8175  | -3.09 | 2.88 |
| 136 | 8.9824  | 8.2623  | 7.5931  | -3.14 | 2.92 |
| 137 | 8.7404  | 8.0329  | 7.3760  | -3.19 | 2.96 |
| 138 | 8.5059  | 7.8108  | 7.1660  | -3.24 | 3.00 |
| 139 | 8.2787  | 7.5958  | 6.9629  | -3.29 | 3.04 |
| 140 | 8.0584  | 7.3875  | 6.7664  | -3.33 | 3.09 |

### 8 Dimensional drawings

unit:mm

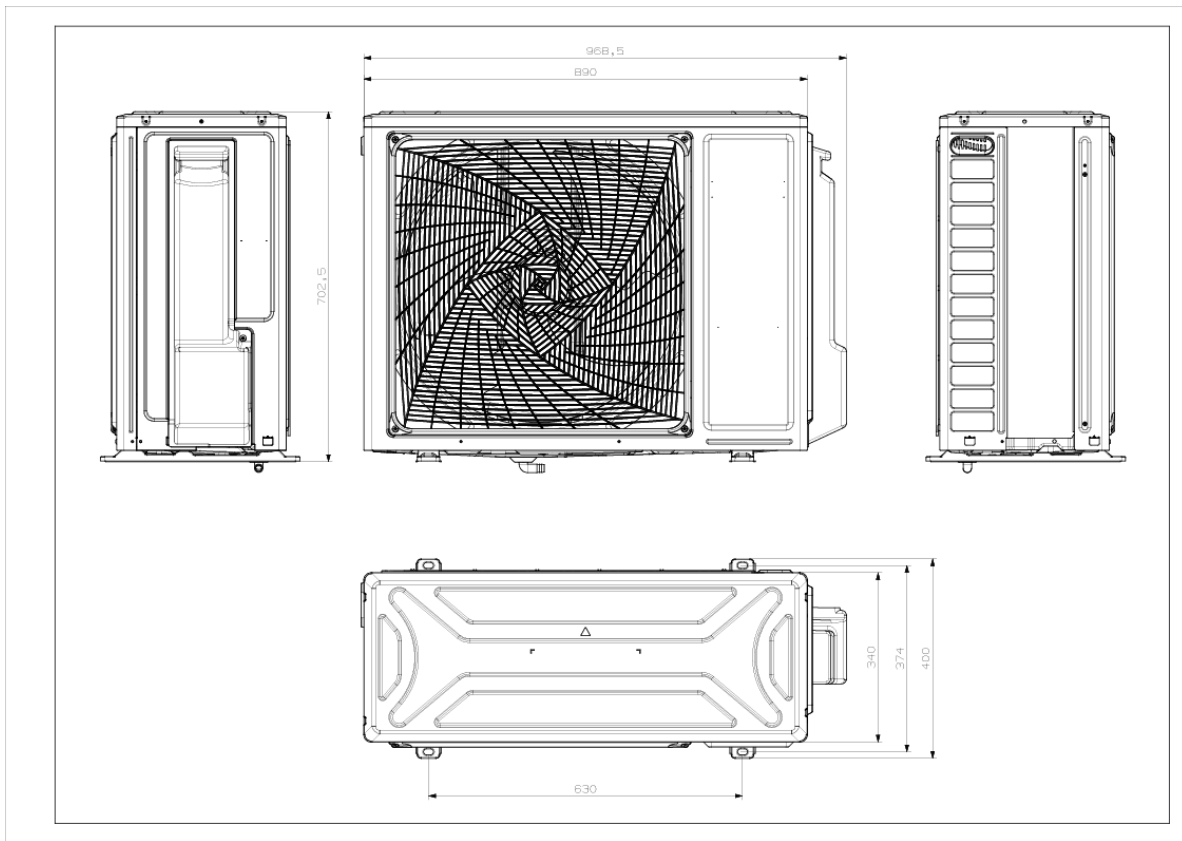

### 9 Center of gravity

unit:mm

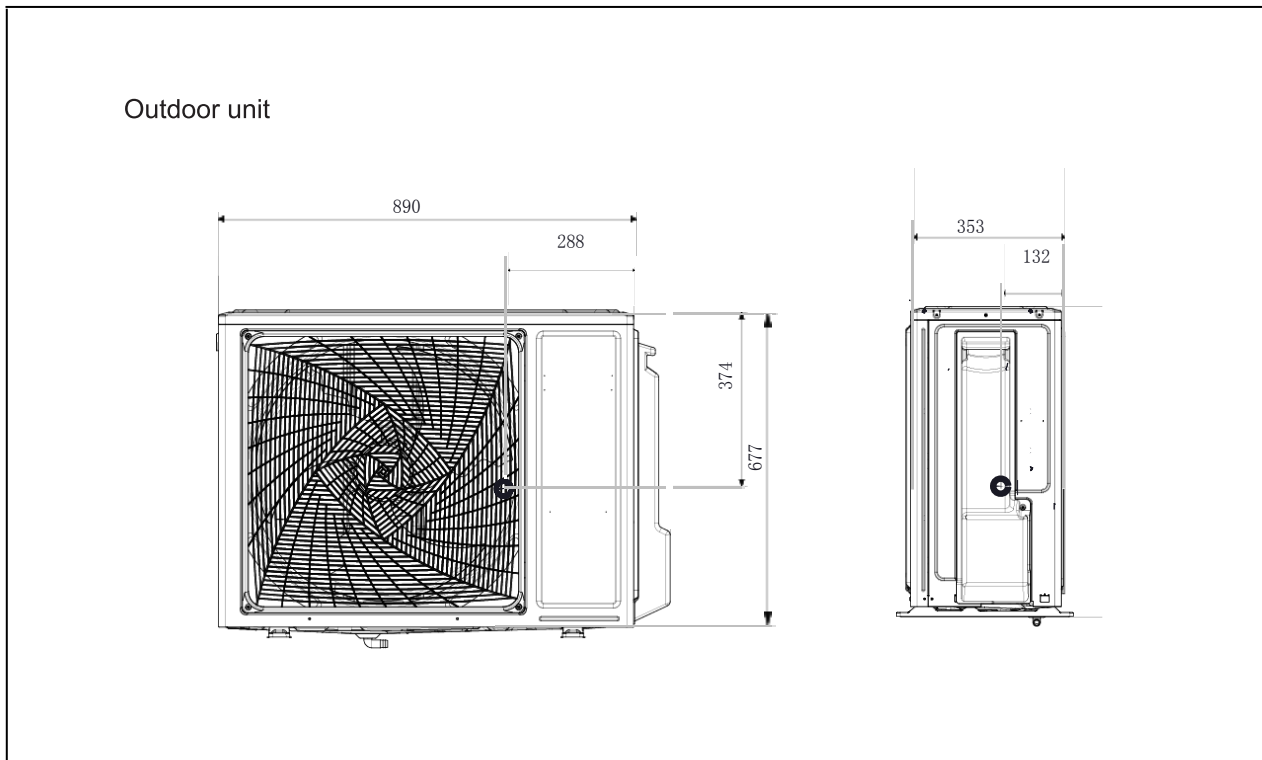

## 10. Service Diagnosis

### 10.1 Caution for Diagnosis

The operation lamp flashes when any of the following errors is detected.

1. When a protection device of the indoor or outdoor unit is activated or when the thermistor malfunctions, disabling equipment operation.
2. When a signal transmission error occurs between the indoor and outdoor units. In either case, conduct the diagnostic procedure described in the following pages.

### 10.2 Problem Symptoms and Measures

| Symptom   | Check Item  | Details of Measure  |
|---|---|---|
| None of the units operates  | Check the power supply.                                       | Check to make sure that the rated voltage is supplied.  |
|   | Check the indoor PCB  | Check to make sure that the indoor PCB is broken  |
| Operation sometimes stops.  | Check the power supply.                                       | A power failure of 2 to 10 cycles can stop air conditioner operation.   |
| Equipment operates but does not cool, or does not heat (only for heat pump) | Check for faulty operation of the electronic expansion valve. | Set the units to cooling operation, and compare the temperatures of the liquid side connection pipes of the connection section among rooms to check the opening and closing operation of the electronic expansion valves of the individual units. |
|   | Diagnosis by service port pressure and operating current.     | Check for insufficient gas.   |
| Large operating noise and vibrations  | Check the installation condition.                             | Check to make sure that the required spaces for installation (specified in the Technical Guide, etc.) are provided.   |

## 10.3 Error Codes and Description indoor display

|                     | Code indication                         |  |   |                            | fault description  | Reference Page |
|---------------------|---|--|---|----------------------------|--|----------------|
|                     | Indoor displaying panel code indication |  |   | Outdoor (LED1 flash times) |  |                |
|                     | Other display                           | Only For 498 and 498A display (Red/Green Time Run <input type="checkbox"/> On <input checked="" type="checkbox"/> Flash <input checked="" type="checkbox"/> Off) |   |                            |  |                |
| Indoor and Outdoor  | E7                                      | Directly display   | <input checked="" type="checkbox"/> <input checked="" type="checkbox"/> <input checked="" type="checkbox"/> | 15                         | Communication fault between indoor and outdoor units   | Page.42        |
| Indoor Malfunction  | E1                                      | Directly display   | <input checked="" type="checkbox"/> <input checked="" type="checkbox"/> <input checked="" type="checkbox"/> | /                          | Indoor temperature sensor failure  | Page.31        |
|                     | E2                                      | Directly display   | <input checked="" type="checkbox"/> <input type="checkbox"/> <input type="checkbox"/>                       | /                          | Indoor coil sensor failure   | Page.31        |
|                     | E4                                      | Directly display   | <input checked="" type="checkbox"/> <input type="checkbox"/> <input checked="" type="checkbox"/>            | /                          | Indoor eeprom failure  | Page.32        |
|                     | E14                                     | Directly display   | <input checked="" type="checkbox"/> <input type="checkbox"/> <input checked="" type="checkbox"/>            | /                          | Indoor fan failure   | Page.33        |
| Outdoor Malfunction | E5                                      | Trouble record   | <input type="checkbox"/> <input checked="" type="checkbox"/> <input checked="" type="checkbox"/>            | 22                         | Internal unit antifreeze protection  | /              |
|                     | E9                                      | Trouble record   | <input type="checkbox"/> <input checked="" type="checkbox"/> <input checked="" type="checkbox"/>            | 21                         | Internal unit overload   | /              |
|                     | F12                                     | Directly display   | <input checked="" type="checkbox"/> <input checked="" type="checkbox"/> <input checked="" type="checkbox"/> | 1                          | Eeprom failure   | Page.32        |
|                     | F1                                      | Directly display   | <input type="checkbox"/> <input checked="" type="checkbox"/> <input checked="" type="checkbox"/>            | 2                          | IPM failure  | Page.36        |
|                     | F22                                     | Directly display   | <input checked="" type="checkbox"/> <input checked="" type="checkbox"/> <input checked="" type="checkbox"/> | 3                          | AC current overcurrent protection  | Page.37        |
|                     | F20                                     | Trouble record   | <input checked="" type="checkbox"/> <input checked="" type="checkbox"/> <input type="checkbox"/>            | 5                          | High pressure protection   | /              |
|                     | F19                                     | Trouble record   | <input checked="" type="checkbox"/> <input checked="" type="checkbox"/> <input type="checkbox"/>            | 6                          | Power over/under voltage protection  | Page.40        |
|                     | F27                                     | Directly display   | <input checked="" type="checkbox"/> <input checked="" type="checkbox"/> <input checked="" type="checkbox"/> | 7                          | Compressor stall / press instantaneous stop  | /              |
|                     | F4                                      | Directly display   | <input checked="" type="checkbox"/> <input checked="" type="checkbox"/> <input checked="" type="checkbox"/> | 8                          | Compressor discharging temperature protection  | Page.41        |
|                     | F8                                      | Trouble record   | <input checked="" type="checkbox"/> <input checked="" type="checkbox"/> <input type="checkbox"/>            | 9                          | Abnormal of DC motor   | Page.41        |
|                     | F21                                     | Directly display   | <input type="checkbox"/> <input type="checkbox"/> <input checked="" type="checkbox"/>                       | 10                         | Abnormal of piping sensor  | Page.31        |
|                     | F7                                      | Directly display   | <input checked="" type="checkbox"/> <input checked="" type="checkbox"/> <input checked="" type="checkbox"/> | 11                         | Suction temperature sensor failure   | Page.31        |
|                     | F6                                      | Directly display   | <input type="checkbox"/> <input checked="" type="checkbox"/> <input checked="" type="checkbox"/>            | 12                         | Abnormal of outdoor ambient sensor   | Page.31        |
|                     | F25                                     | Directly display   | <input checked="" type="checkbox"/> <input type="checkbox"/> <input checked="" type="checkbox"/>            | 13                         | Abnormal of compressor discharge sensor  | Page.31        |
|                     | F13                                     | Trouble record   | <input checked="" type="checkbox"/> <input checked="" type="checkbox"/> <input type="checkbox"/>            | 16                         | Lack of refrigerant  | /              |
|                     | F14                                     | Trouble record   | <input checked="" type="checkbox"/> <input checked="" type="checkbox"/> <input type="checkbox"/>            | 17                         | 4-way valve reverse failure  | /              |
|                     | F11                                     | Directly display   | <input checked="" type="checkbox"/> <input checked="" type="checkbox"/> <input checked="" type="checkbox"/> | 18                         | Compressor jam (only for spdu)   | Page.44        |
|                     | F28                                     | Directly display   | <input checked="" type="checkbox"/> <input checked="" type="checkbox"/> <input checked="" type="checkbox"/> | 19                         | Module PWM select circuit error  | Page.44        |
|                     | F15                                     | Trouble record   | <input checked="" type="checkbox"/> <input checked="" type="checkbox"/> <input type="checkbox"/>            | 20                         | Outdoor terminal block temperature protection  | /              |
|                     | F2                                      | Trouble record   | <input checked="" type="checkbox"/> <input checked="" type="checkbox"/> <input type="checkbox"/>            | 24                         | Instantaneous over-current protection of the compressor  | Page.37        |
|                     | F23                                     | Trouble record   | <input checked="" type="checkbox"/> <input checked="" type="checkbox"/> <input type="checkbox"/>            | 25                         | Compressor U-phase overcurrent<br>Compressor V-phase overcurrent<br>Compressor W-phase overcurrent | Page.42        |
|                     | F9                                      | Trouble record   | /   | 26                         | Module reset   | /              |
|                     | F24                                     | Trouble record   | <input checked="" type="checkbox"/> <input checked="" type="checkbox"/> <input checked="" type="checkbox"/> | 27                         | CT disconnection   | /              |
|                     | F34                                     | Trouble record   | /   | 37                         | Outdoor coil protection  | /              |
|                     | F35                                     | Trouble record   | <input checked="" type="checkbox"/> <input checked="" type="checkbox"/> <input type="checkbox"/>            | 38                         | Compressor driver board failure  | /              |
|                     | F43                                     | /  | <input checked="" type="checkbox"/> <input checked="" type="checkbox"/> <input checked="" type="checkbox"/> | 46                         | Model matching abnormality   | /              |



### 10.3.1 Thermistor or Related Abnormality

- |                 |  |
|-----------------|--|
| Indoor Display  | E1: Room temperature sensor failure<br>E2: Heat-exchange sensor failure  |
| Outdoor display | LED1 flash 10 times: Defrost temperature sensor failure<br>LED1 flash 11 times: Suction temperature sensor failure<br>LED1 flash 12 times: Ambient temperature sensor failure<br>LED1 flash 13 times: Discharge temperature sensor failure |

**Method of Malfunction Detection**

The temperatures detected by the thermistors are used to determine thermistor errors

**Malfunction Decision Conditions**

When the thermistor input is more than 4.92V or less than 0.08V during compressor operation.

- Note: The values vary slightly in some models

**Supposed Causes**

- Faulty connector connection
- Faulty thermistor
- Faulty PCB

**Troubleshooting**

\* Caution Be sure to turn off power switch before connect or disconnect connector, or else parts damage may be occurred.

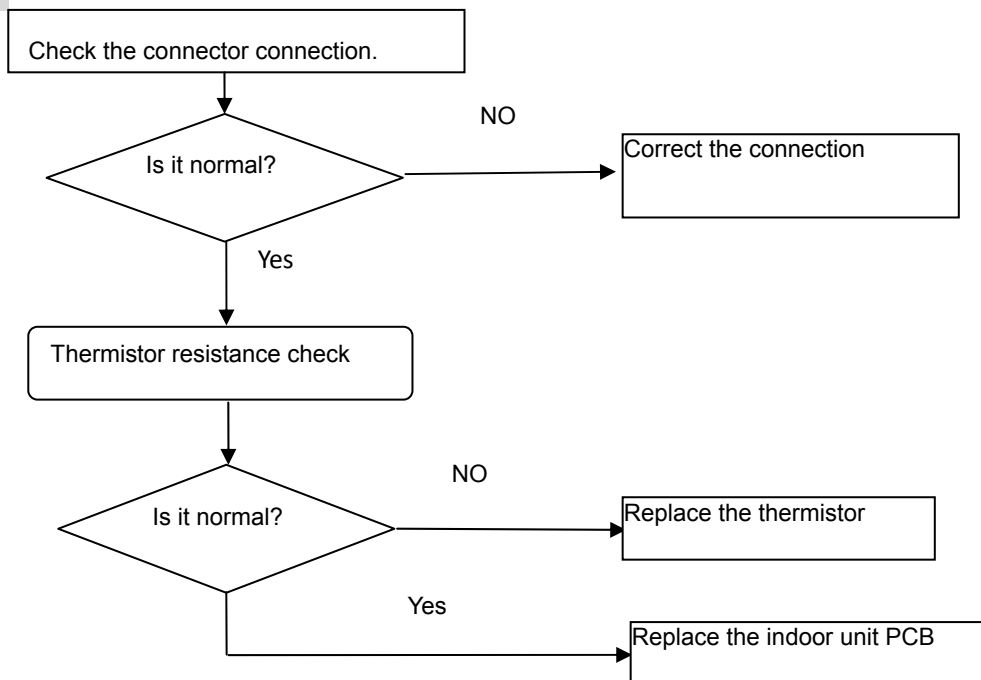

Thermistor resistance check method:

Remove the connector of the thermistor on the PCB, and measure the resistance of thermistor using tester. The relationship between normal temperature and resistance is shown in the value of indoor thermistor.

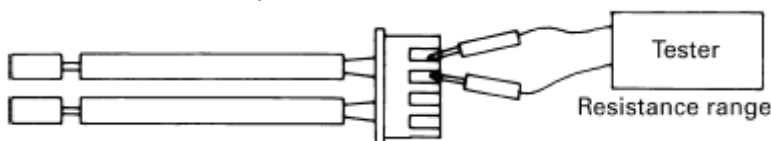

### 10.3.2 EEPROM abnormal

---

Indoor Display

E4: Indoor EEPROM error

Indoor display

F12: Outdoor EEPROM error; Outdoor LED1 flash 1 times

---

Method of  
Malfunction  
Detection

The Data detected by the EEPROM are used to determine MCU

---

Malfunction  
Decision  
Conditions

When the data of EEPROM is error or the EEPROM is damaged

---

Supposed  
Causes

- Faulty EEPROM data
  - Faulty EEPROM
  - Faulty PCB
- 

Troubleshooting

\* Caution Be sure to turn off power switch before connect or disconnect connector, or parts damage may be occurred.

Replace the indoor or outdoor mainboard.

### 10.3.3 Indoor AC fan motor malfunction

Indoor Display E14

Method of Malfunction Detection

The rotation speed detected by the Hall IC during fan motor operation is used to determine abnormal fan motor operation

Malfunction Decision Conditions

when the detected rotation feedback signal don't received in 2 minutes

Supposed Causes

- Operation halt due to breaking of wire inside the fan motor.
- Fan motor overheat protection
- Operation halt due to breaking of the fan motor lead wires
- Detection error due to faulty indoor unit PCB

Troubleshooting

\* Caution Be sure to turn off power switch before connect or disconnect connector, or else parts damage may be occurred.

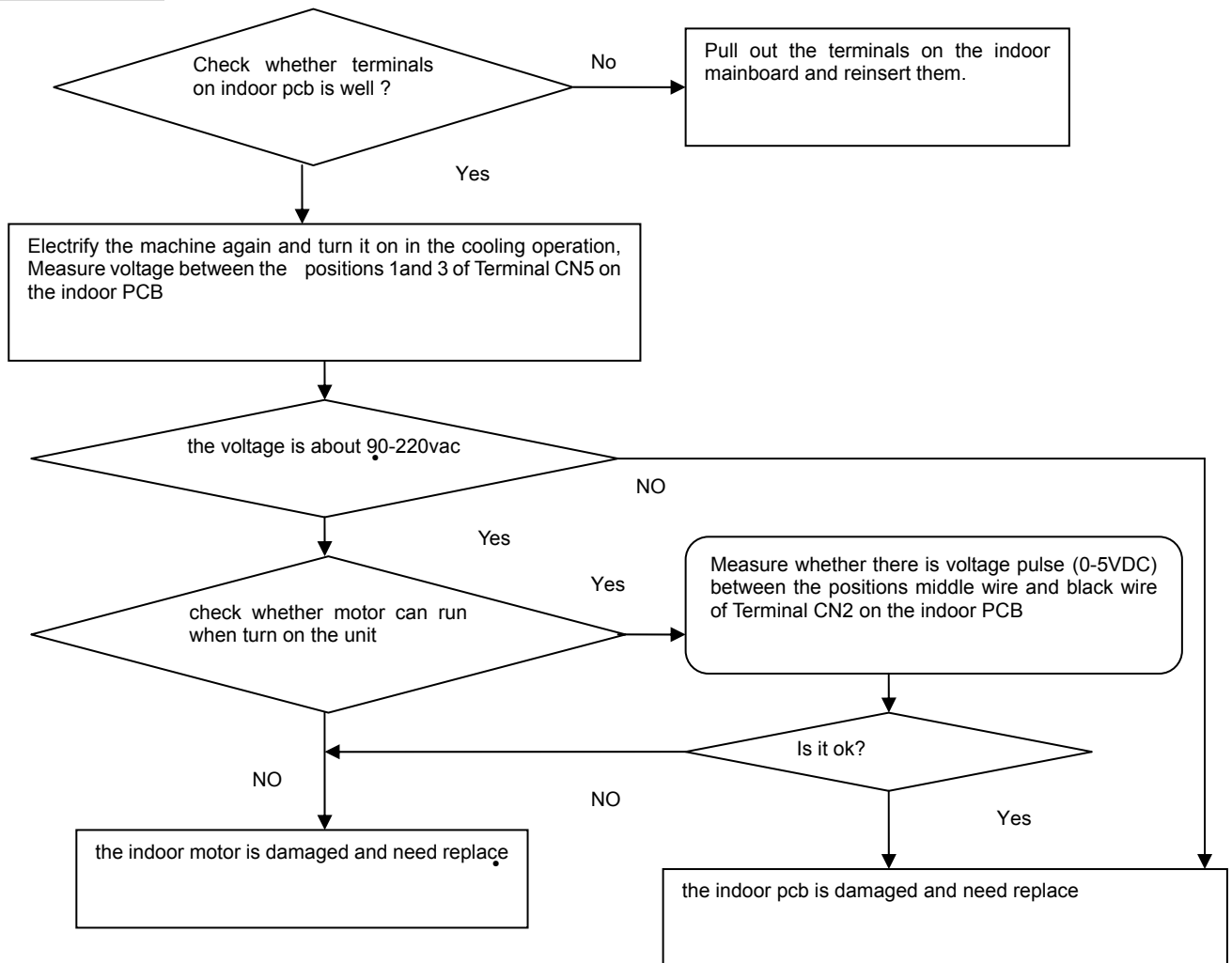

### 10.3.4 Outdoor DC fan motor fault

Outdoor display LED1 flash 9 times

Method of

DC fan motor is detected by checking the fan running condition and so on

Malfunction  
Detection

Malfunction  
Decision  
Conditions

when the data of EEPROM is error or the EEPROM is damaged

Supposed  
Causes

- DC fan motor protection dues to the DC fan motor faulty
- DC fan motor protection dues to faulty PCB

Troubleshooting

\* Caution Be sure to turn off power switch before connect or disconnect connector, or parts damage may be occurred.

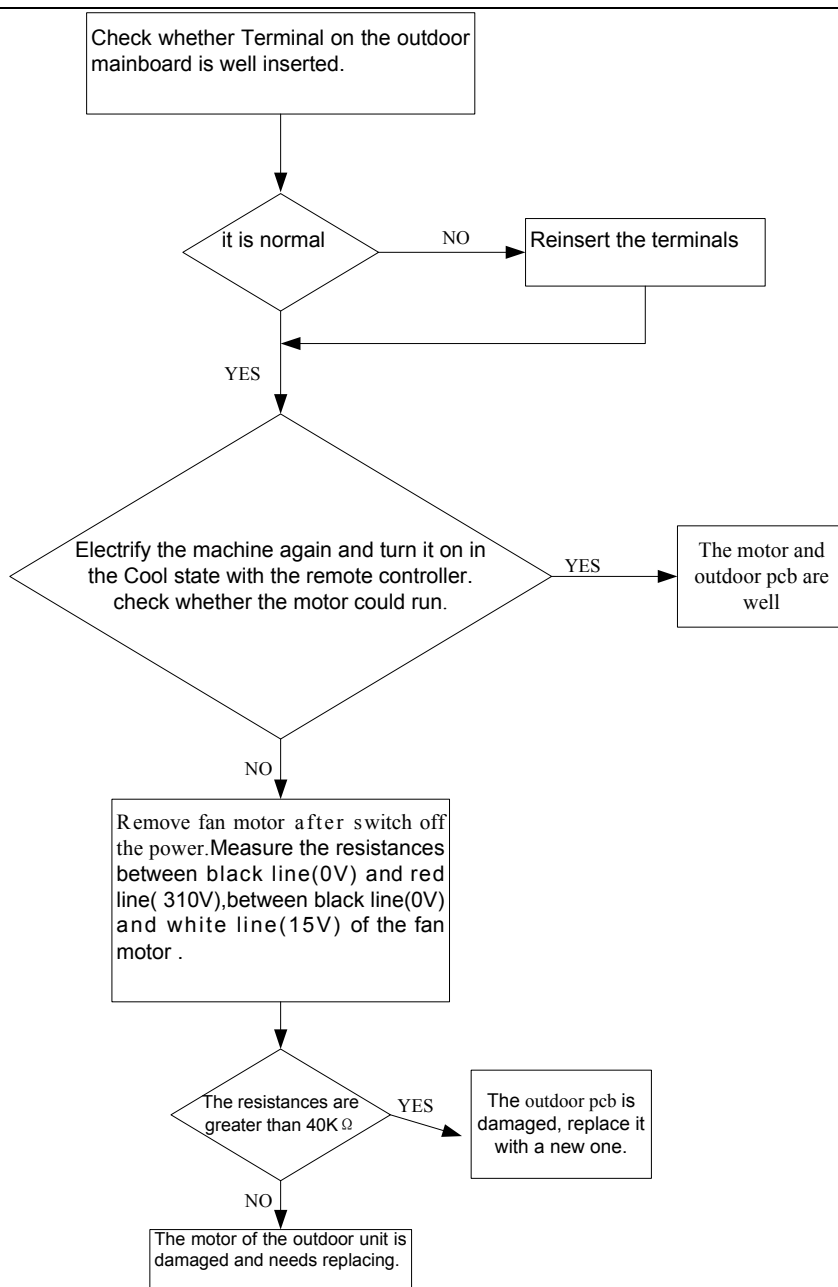

### 10.3.5 IPM protection

Outdoor display: LED1 flash 2 times

Method of Malfunction Detection

IPM protection is detected by checking the compressor running condition and so on

Malfunction Decision Conditions

- The system leads to IPM protection due to over current
- The compressor faulty leads to IPM protection
- circuit component of IPM is broken and led to IPM protection

Supposed Causes

- IPM protection dues to the compressor faulty
- IPM protection dues to faulty PCB of IPM module
- Compressor wiring disconnected

Troubleshooting

\* Caution Be sure to turn off power switch before connect or disconnect connector, or else parts damage may be occurred.

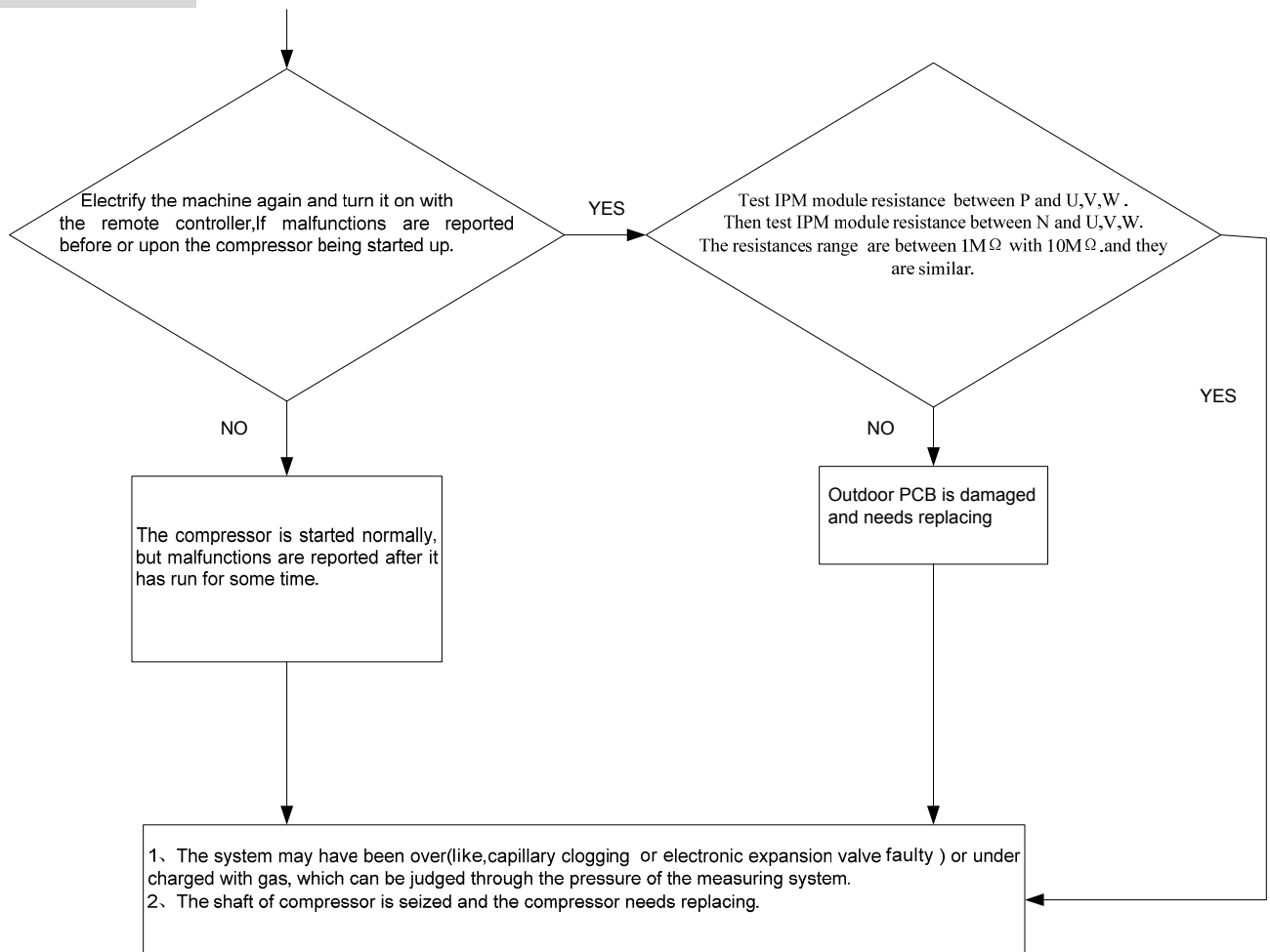

### 10.3.6 Over-current of the compressor

Outdoor Display: LED1 flash 3 or 24 or 25 times

|                                 |   |
|---------------------------------|---|
| Method of Malfunction Detection | The current of the compressor is too high   |
| Malfunction Decision Conditions | when the IPM Module is damaged or the compressor is damaged.<br>power supply voltage is too low or too high                       |
| Supposed Causes                 | <ul style="list-style-type: none"> <li>■ Faulty IPM Module</li> <li>■ Faulty compressor</li> <li>■ Faulty power supply</li> </ul> |
| Troubleshooting                 | * Caution Be sure to turn off power switch before connect or disconnect connector, or parts damage may be occurred.               |

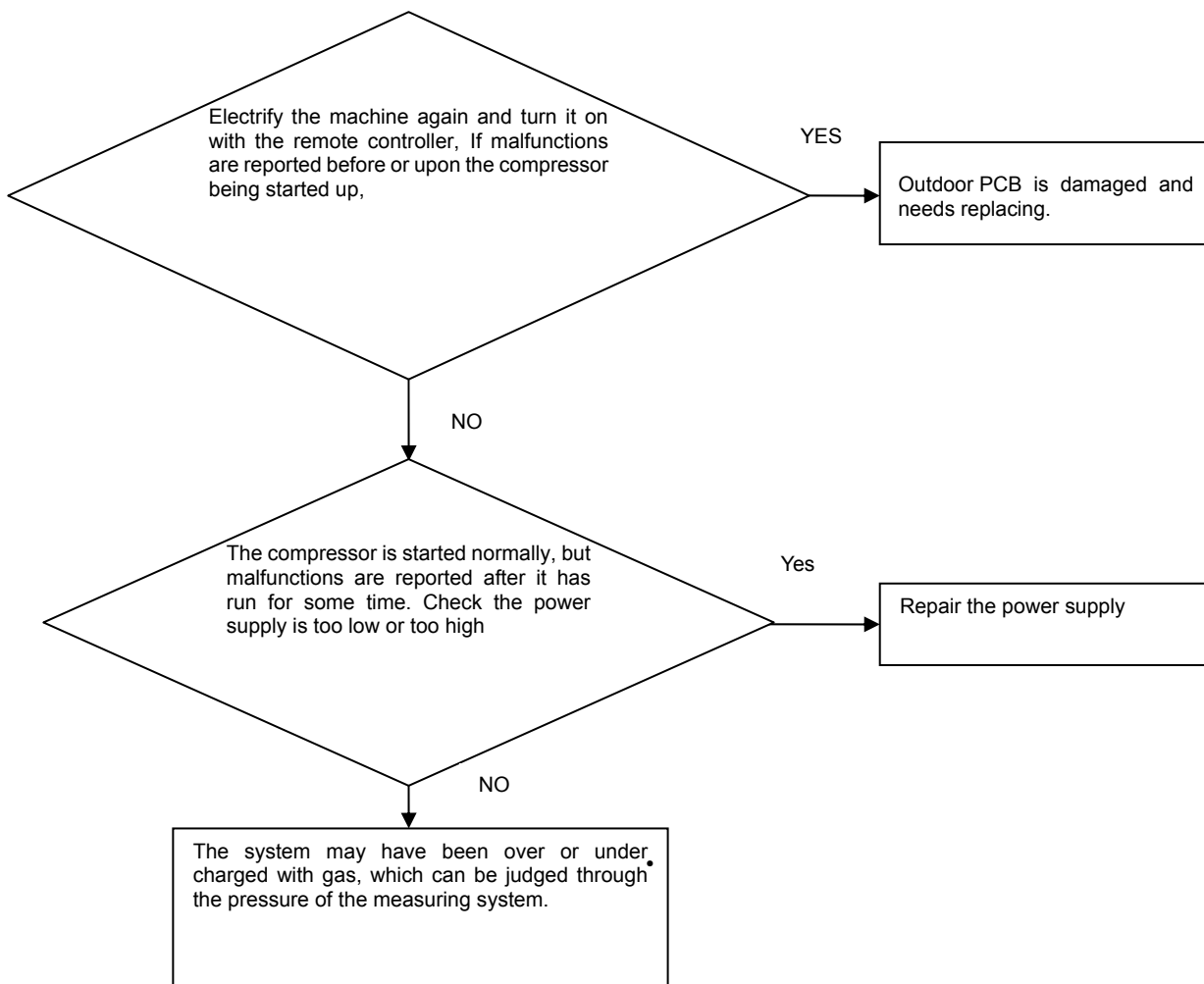

### 10.3.7 Power Supply Over or under voltage fault

Outdoor display: LED1 flash 6 times The power supply is over voltage

Method of Malfunction Detection

An abnormal voltage rise or fall is detected by checking the specified voltage detection circuit.

Malfunction Decision Conditions

An voltage signal is fed from the voltage detection circuit to the microcomputer

Supposed Causes

- Supply voltage not as specified
- the IPM module is broken
- the outdoor PCB is broken

Troubleshooting

\* Caution Be sure to turn off power switch before connect or disconnect connector, or else parts damage may be occurred.

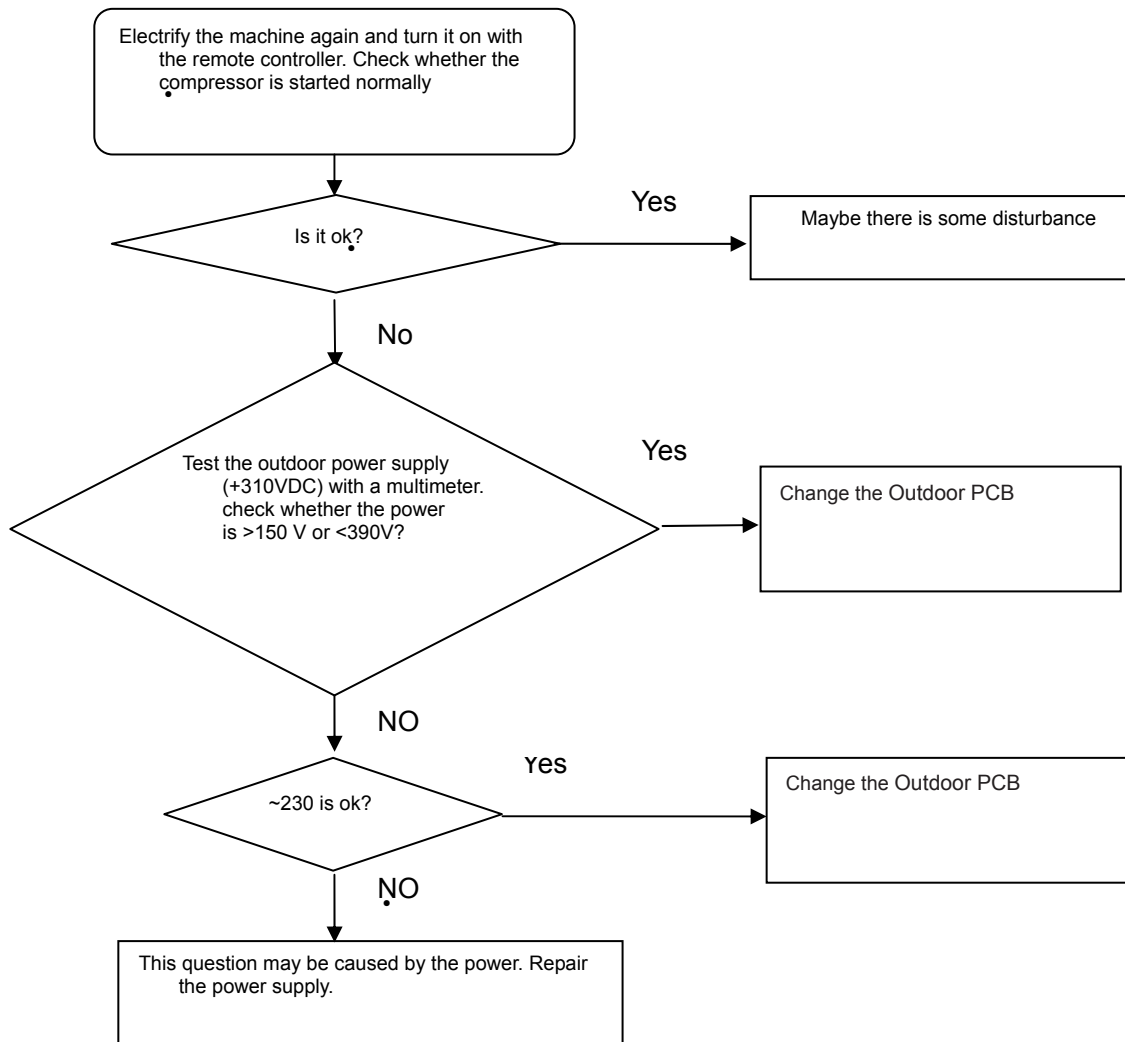



### 10.3.8 Overheat Protection For Discharge Temperature

Outdoor display: LED1 flash 8 times

Method of Malfunction Detection

The Discharge temperature control is checked with the temperature being detected by the Discharge pipe thermistor

Malfunction Decision Conditions

when the compressor discharge temperature is above 110°C

Supposed Causes

- Electronic expansion valve defective
- Faulty thermistor
- Faulty PCB

Troubleshooting

\* Caution Be sure to turn off power switch before connect or disconnect connector, or else parts damage may be occurred.

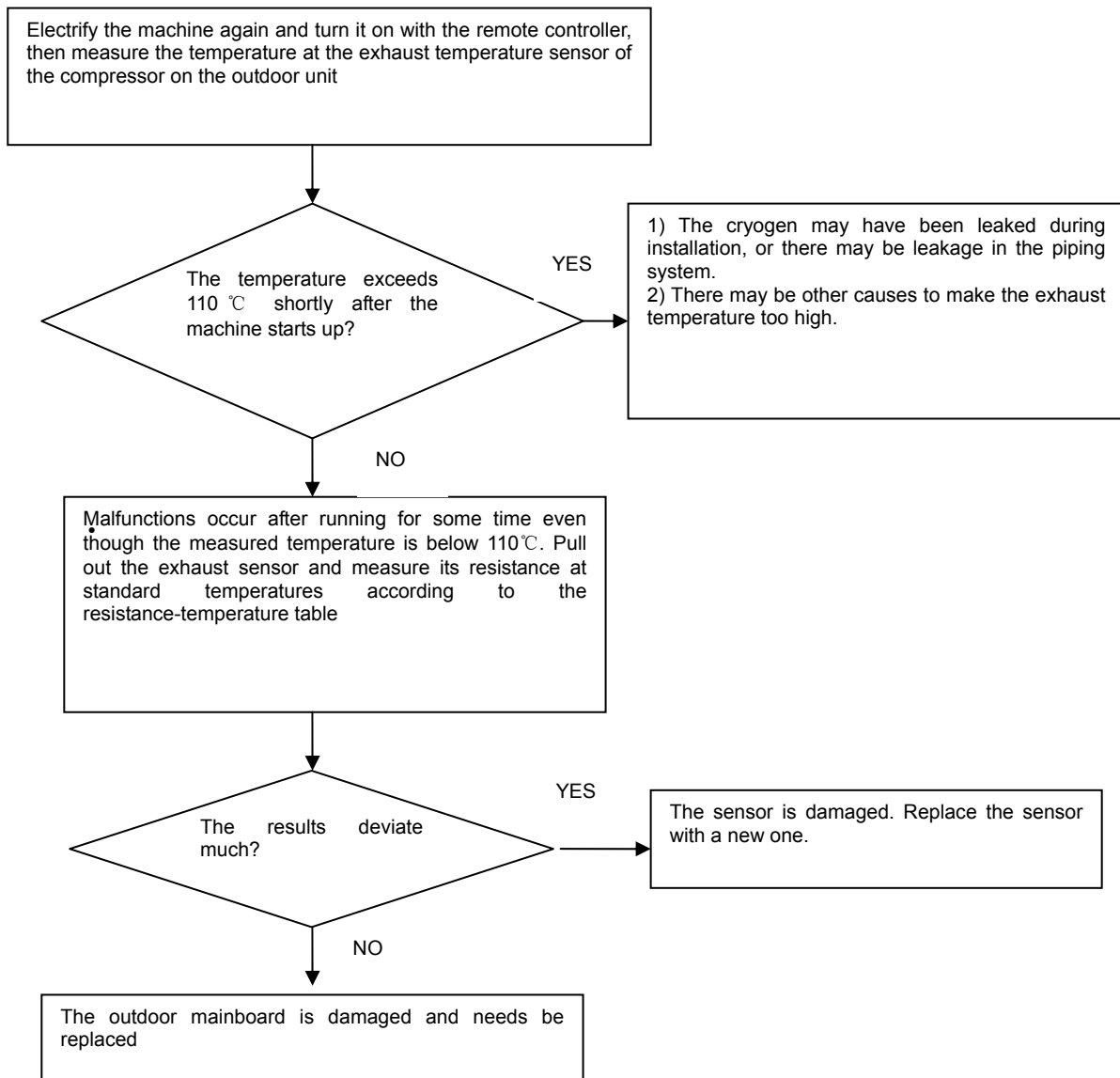

### 10.3.9 The communication fault between indoor and outdoor

|                                 |   |
|---------------------------------|---|
| Indoor display                  | E7  |
| outdoor display                 | LED1 flash 15 times   |
| Method of Malfunction Detection | Communication is detected by checking the indoor PCB and the outdoor PCB.   |
| Malfunction Decision Conditions | <ul style="list-style-type: none"> <li>■ The outdoor PCB broken leads to communication fault.</li> <li>■ The indoor PCB broken leads to communication fault.</li> </ul> |
| Supposed Causes                 | <ul style="list-style-type: none"> <li>■ Communication wiring disconnected.</li> <li>■ The indoor PCB is broken.</li> <li>■ The outdoor PCB is broken.</li> </ul>       |
| Troubleshooting                 | <p>* Caution Be sure to turn off power switch before connect or disconnect connector, or else parts damage may be occurred.</p>   |

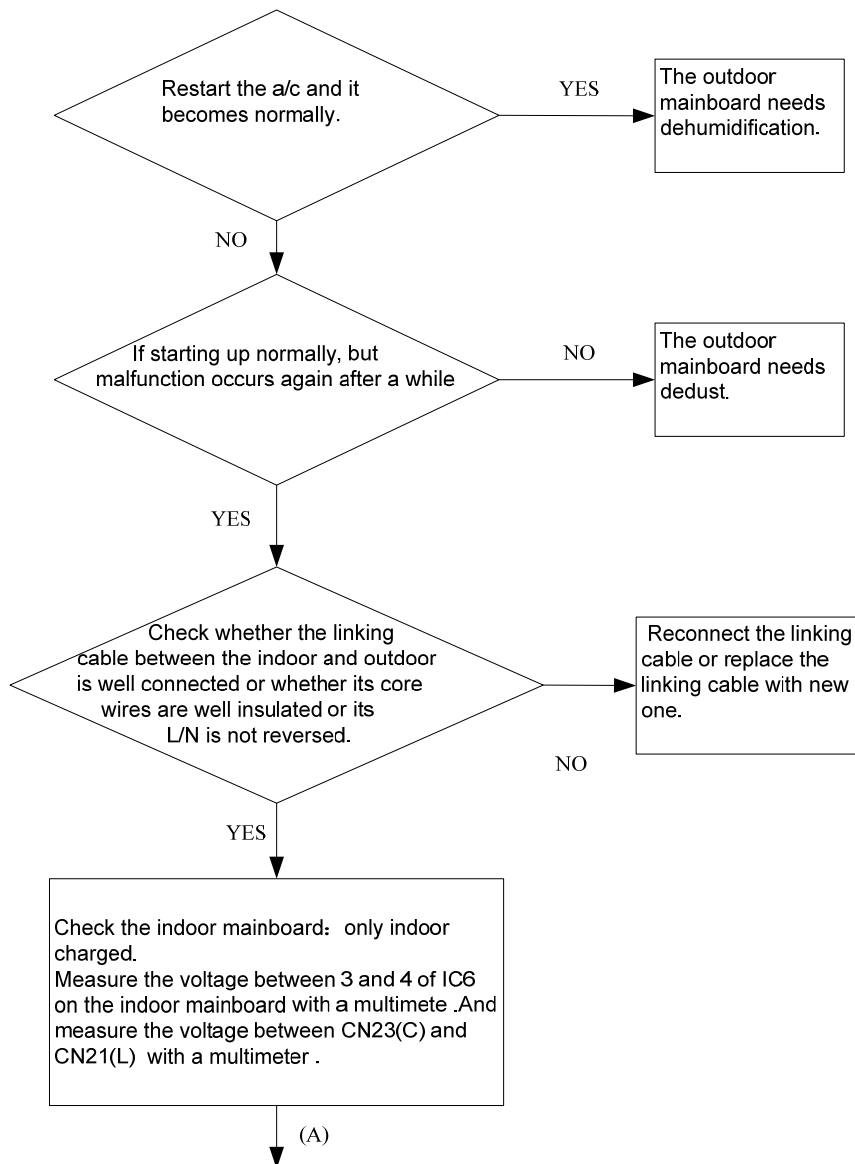

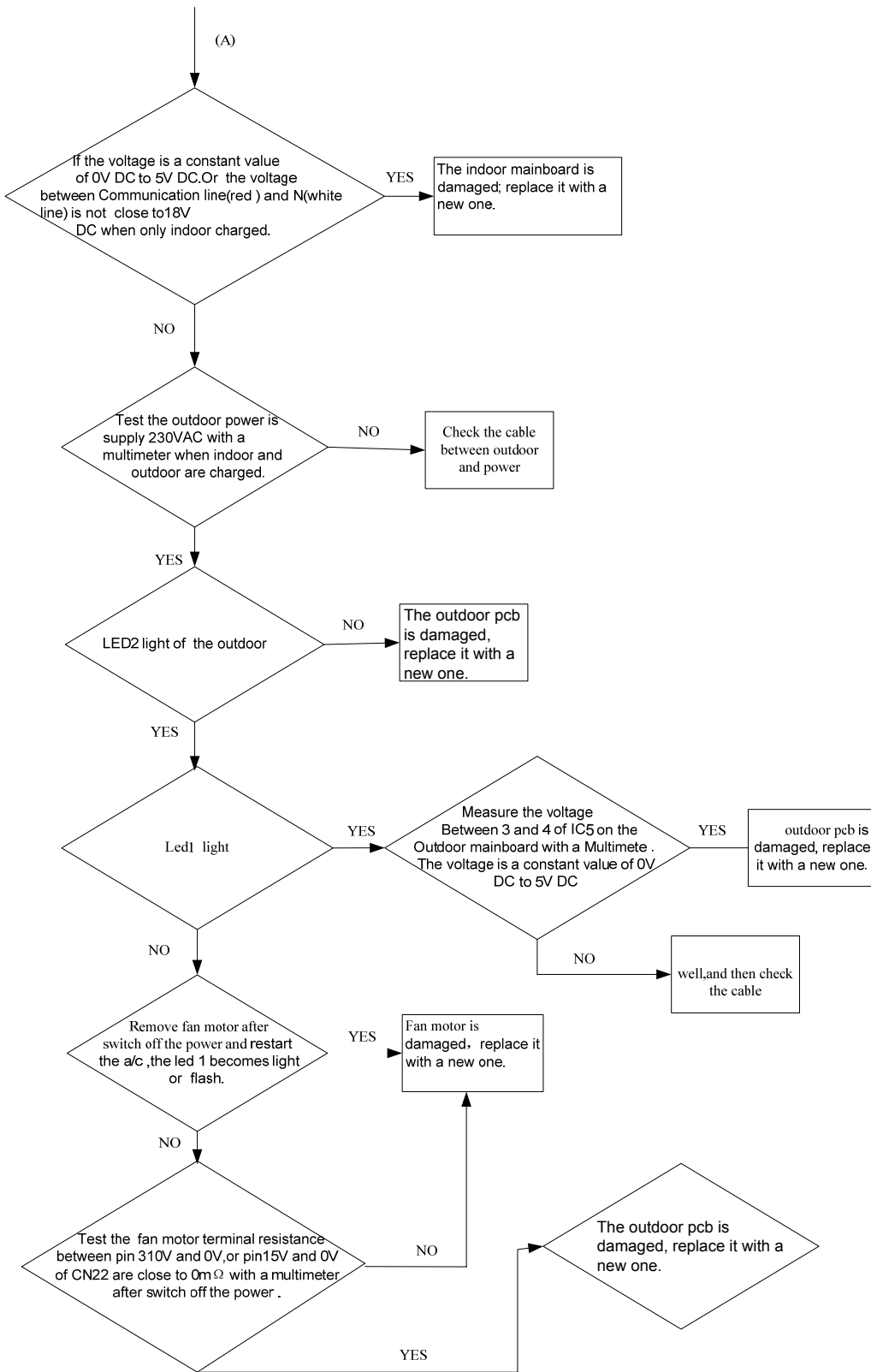

### 10.3.10 Loss of synchronism detection Inverter side current detection is abnormal

Outdoor Display LED1 flash 18 times  
LED1 flash 19 times

Method of Malfunction Detection

The position of the compressor rotor can not detected normally

Malfunction Decision Conditions

when the wiring of compressor is wrong or the connection is poor; or the compressor is damaged

Supposed Causes

- Faulty The wiring of compressor
- Faulty compressor
- Faulty PCB

Troubleshooting

\* Caution Be sure to turn off power switch before connect or disconnect connector, or parts damage may be occurred.

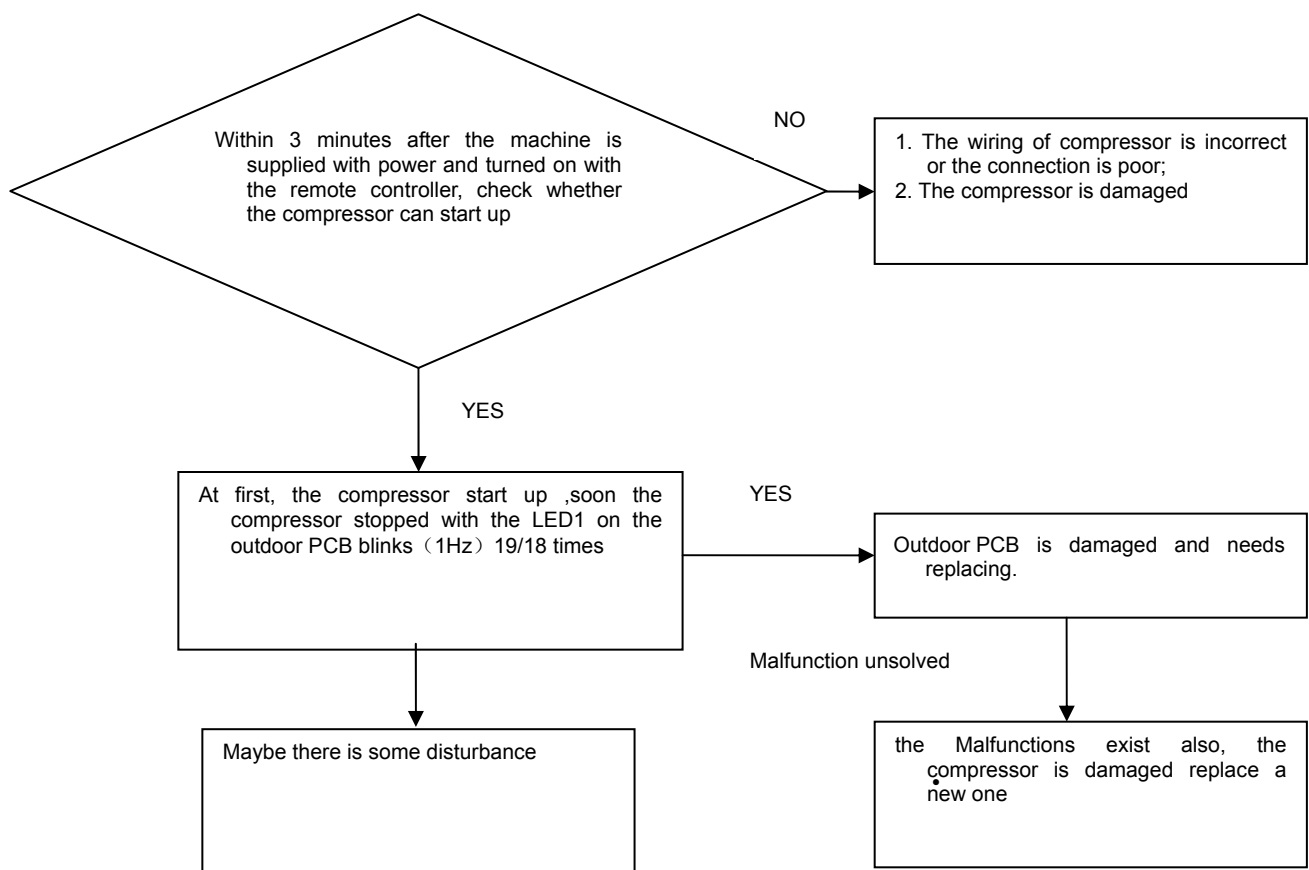

### 10.3.11 High work-intense protection

Outdoor display

LED1 flash 21 times

Method of Malfunction Detection

High work-intense control is activated in the heating mode if the temperature being sensed by the heat exchanger thermistor exceeds the limit.

Malfunction Decision Conditions

Activated when the temperature being sensed by the heat exchanger rises above 65°C twice in 30 minutes.

Supposed Causes

- Faulty electronic expansion valve
- Dirty heat exchanger
- Faulty heat-exchange sensor
- Insufficient gas

Troubleshooting

\* Caution Be sure to turn off power switch before connect or disconnect connector, or else parts damage may be occurred.

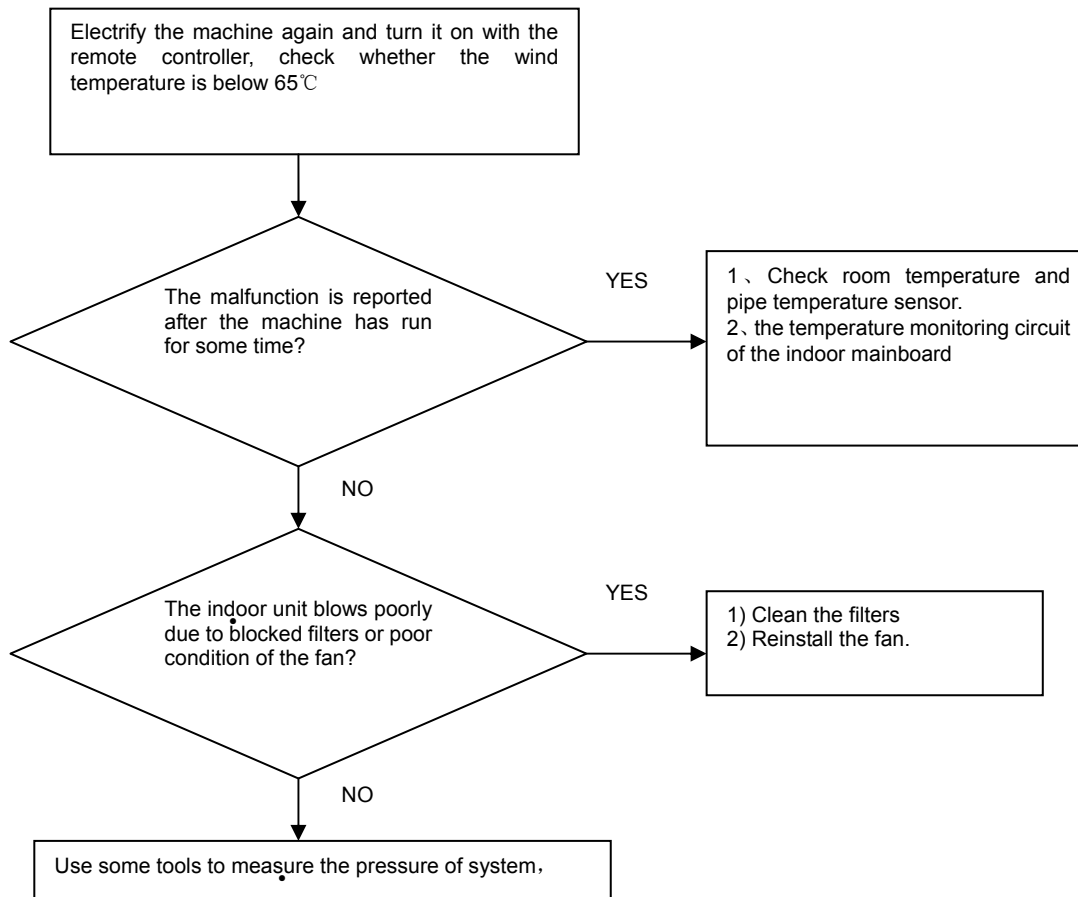

# 11. Performance and cerves diagrams

## 11.1 Cooling capacity-temperature curves

| performance curves             |               |      |      |      |      |      |      |      |      |
|--------------------------------|---------------|------|------|------|------|------|------|------|------|
| cooling value-temerature table |               |      |      |      |      |      |      |      |      |
| indoor temp.                   | outdoor temp. |      |      |      |      |      |      |      |      |
| DB/WB                          | 10°C          | 15°C | 20°C | 25°C | 30°C | 35°C | 38°C | 40°C | 43°C |
| 21/15°C                        | 5133          | 5105 | 5048 | 4714 | 5736 | 6300 | 6299 | 6035 | 5644 |
| 24/16°C                        | 5459          | 5335 | 5188 | 4962 | 6081 | 6741 | 6598 | 6219 | 5960 |
| 27/19°C                        | 6047          | 6011 | 5759 | 5466 | 6892 | 7583 | 7152 | 7085 | 6549 |
| 30/22°C                        | 6423          | 6286 | 6150 | 5808 | 7175 | 7858 | 7653 | 7380 | 6901 |
| 32/23°C                        | 6814          | 6716 | 6524 | 6215 | 7701 | 8304 | 8167 | 7880 | 7373 |
| 35/24°C                        | 7144          | 6973 | 6792 | 6492 | 7775 | 8652 | 8392 | 8004 | 7624 |

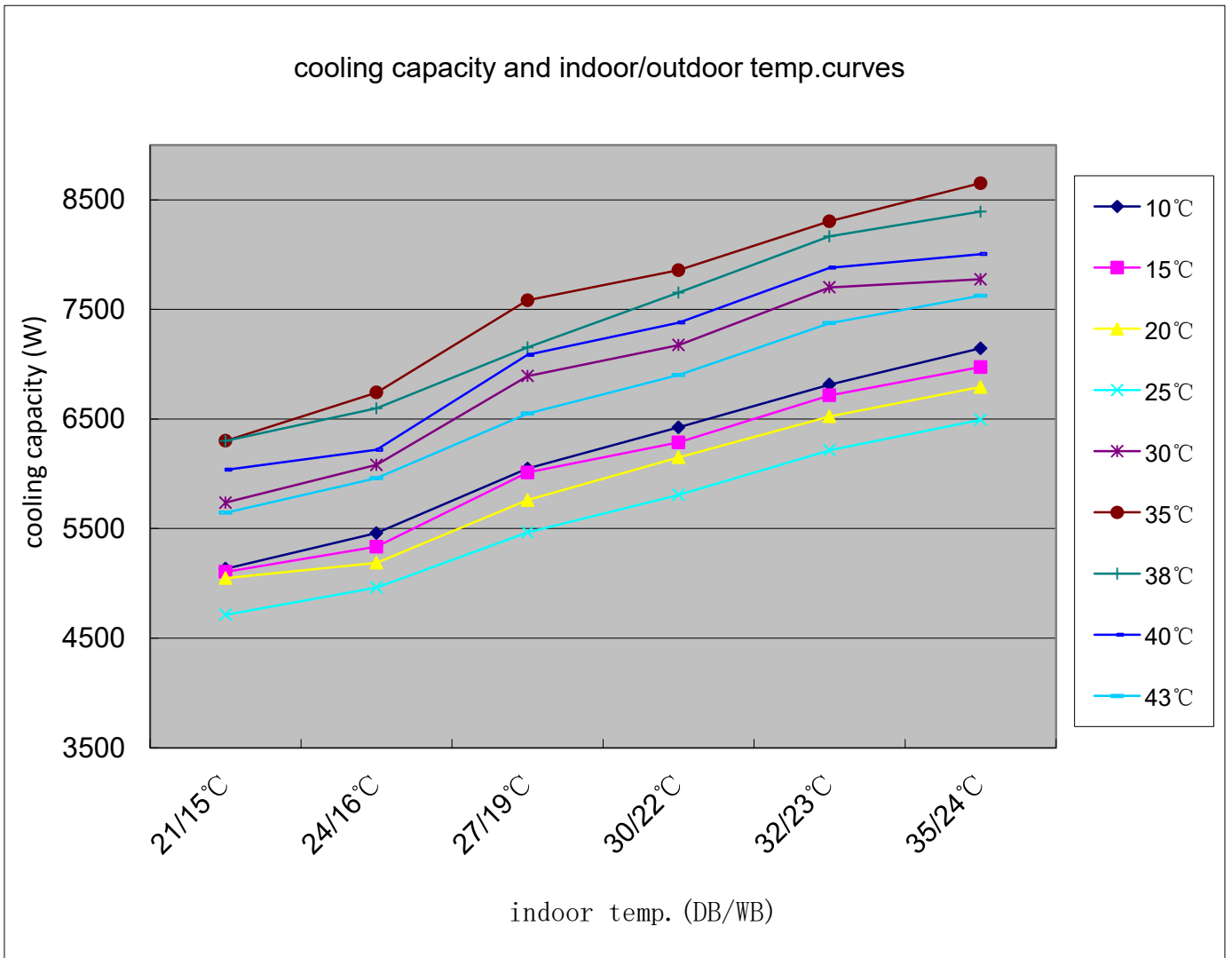

### 11.2 Cooling power consumption value- temperature curves

| performance curves                 |               |      |      |      |      |      |      |      |      |
|------------------------------------|---------------|------|------|------|------|------|------|------|------|
| power consumption value-temp.table |               |      |      |      |      |      |      |      |      |
| indoor temp.                       | outdoor temp. |      |      |      |      |      |      |      |      |
| DB/WB                              | 10°C          | 15°C | 20°C | 25°C | 30°C | 35°C | 38°C | 40°C | 43°C |
| 21/15°C                            | 1656          | 1647 | 1628 | 972  | 1341 | 1739 | 2185 | 2499 | 2657 |
| 24/16°C                            | 1706          | 1667 | 1621 | 1006 | 1405 | 1827 | 2235 | 2526 | 2760 |
| 27/19°C                            | 1833          | 1822 | 1745 | 1090 | 1568 | 2021 | 2334 | 2773 | 2960 |
| 30/22°C                            | 1889          | 1849 | 1809 | 1120 | 1582 | 2021 | 2410 | 2847 | 3043 |
| 32/23°C                            | 1947          | 1919 | 1864 | 1199 | 1698 | 2136 | 2653 | 3040 | 3251 |
| 35/24°C                            | 1984          | 1937 | 1887 | 1252 | 1714 | 2225 | 2726 | 3088 | 3362 |

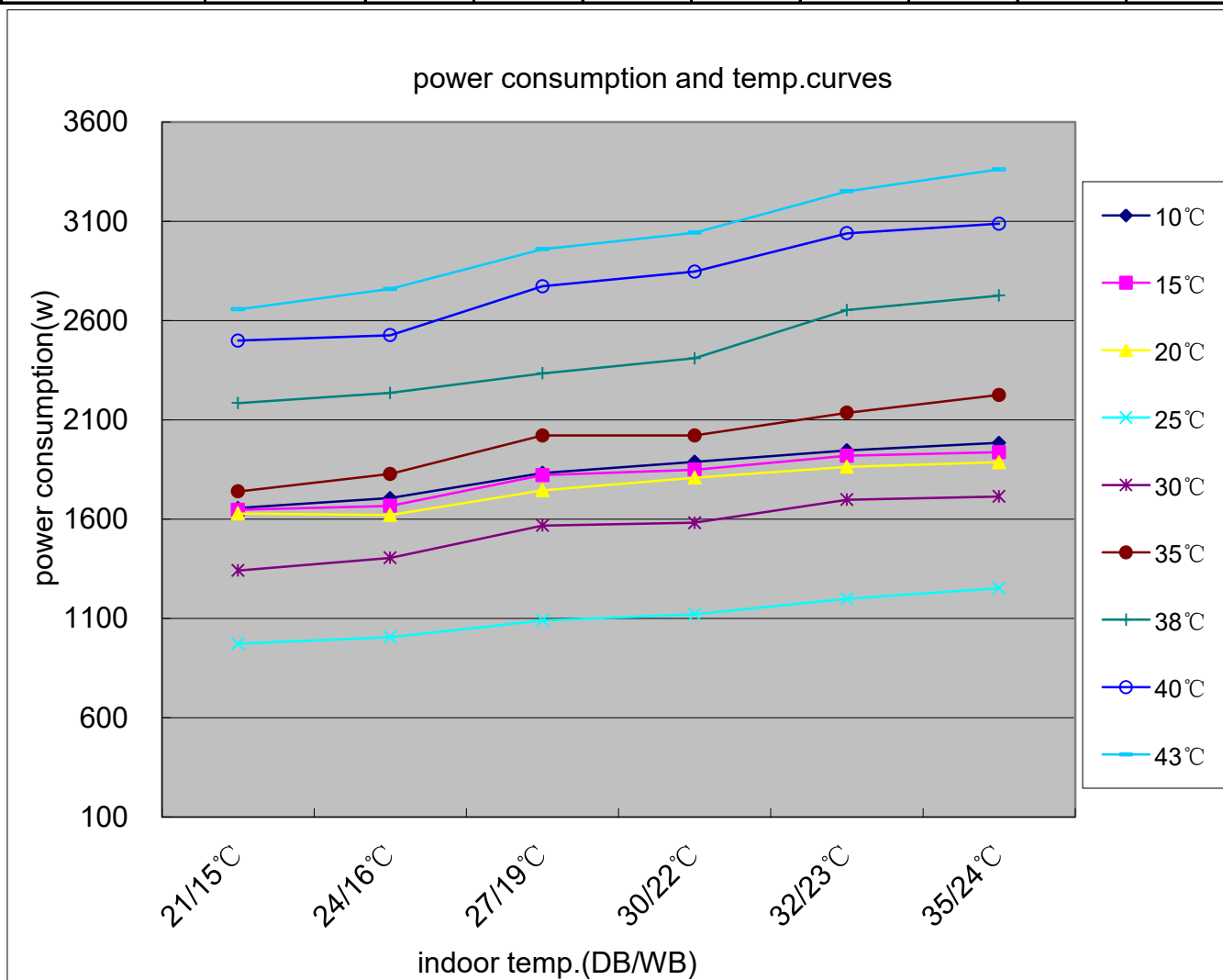

### 11.3 Cooling discharge pressure curves

| performance curves               |              |         |         |
|----------------------------------|--------------|---------|---------|
| cooling discharge pressure.table |              |         |         |
| outdoor temp.<br>(humidity 46%)  | indoor temp. |         |         |
| DB/WB                            | 21/15°C      | 27/19°C | 35/24°C |
| 10°C                             | 1884         | 1986    | 2056    |
| 15°C                             | 1905         | 2012    | 2088    |
| 20°C                             | 1956         | 2039    | 2169    |
| 25°C                             | 2006         | 2118    | 2202    |
| 30°C                             | 2187         | 2357    | 2461    |
| 35°C                             | 2433         | 2516    | 2621    |
| 38°C                             | 2618         | 2701    | 2876    |
| 40°C                             | 2895         | 3045    | 3166    |
| 43°C                             | 3286         | 3442    | 3582    |

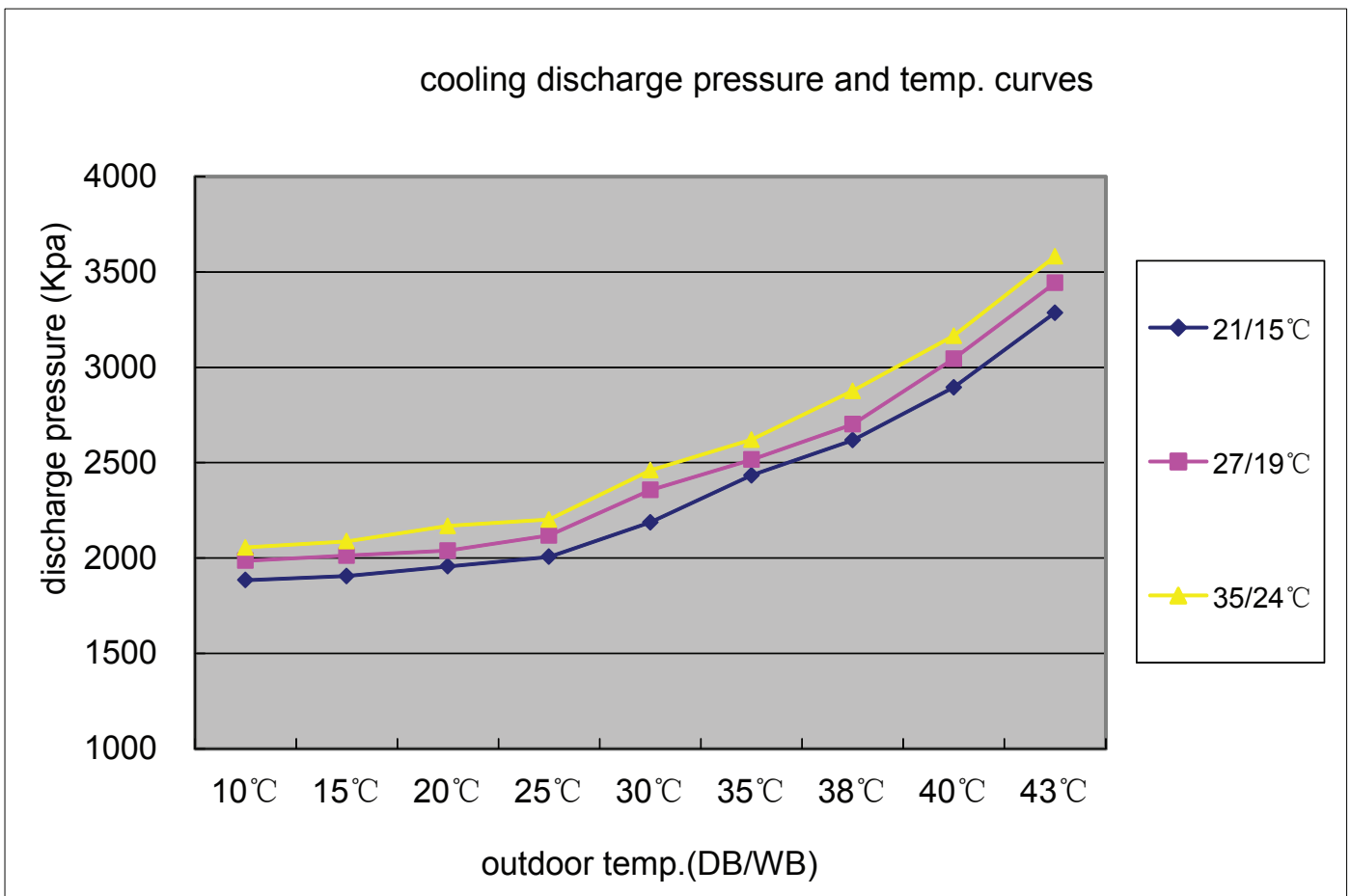



### 11.4 Cooling suction pressure curves

| performance curves              |              |         |         |
|---------------------------------|--------------|---------|---------|
| cooling suction pressure.table  |              |         |         |
| outdoor temp.<br>(humidity 46%) | indoor temp. |         |         |
| DB/WB                           | 21/15°C      | 27/19°C | 35/24°C |
| 10°C                            | 739          | 865     | 1005    |
| 15°C                            | 746          | 874     | 1015    |
| 20°C                            | 754          | 891     | 1025    |
| 25°C                            | 794          | 900     | 1046    |
| 30°C                            | 835          | 948     | 1057    |
| 35°C                            | 844          | 957     | 1112    |
| 38°C                            | 888          | 987     | 1135    |
| 40°C                            | 977          | 1086    | 1249    |
| 43°C                            | 1075         | 1173    | 1361    |

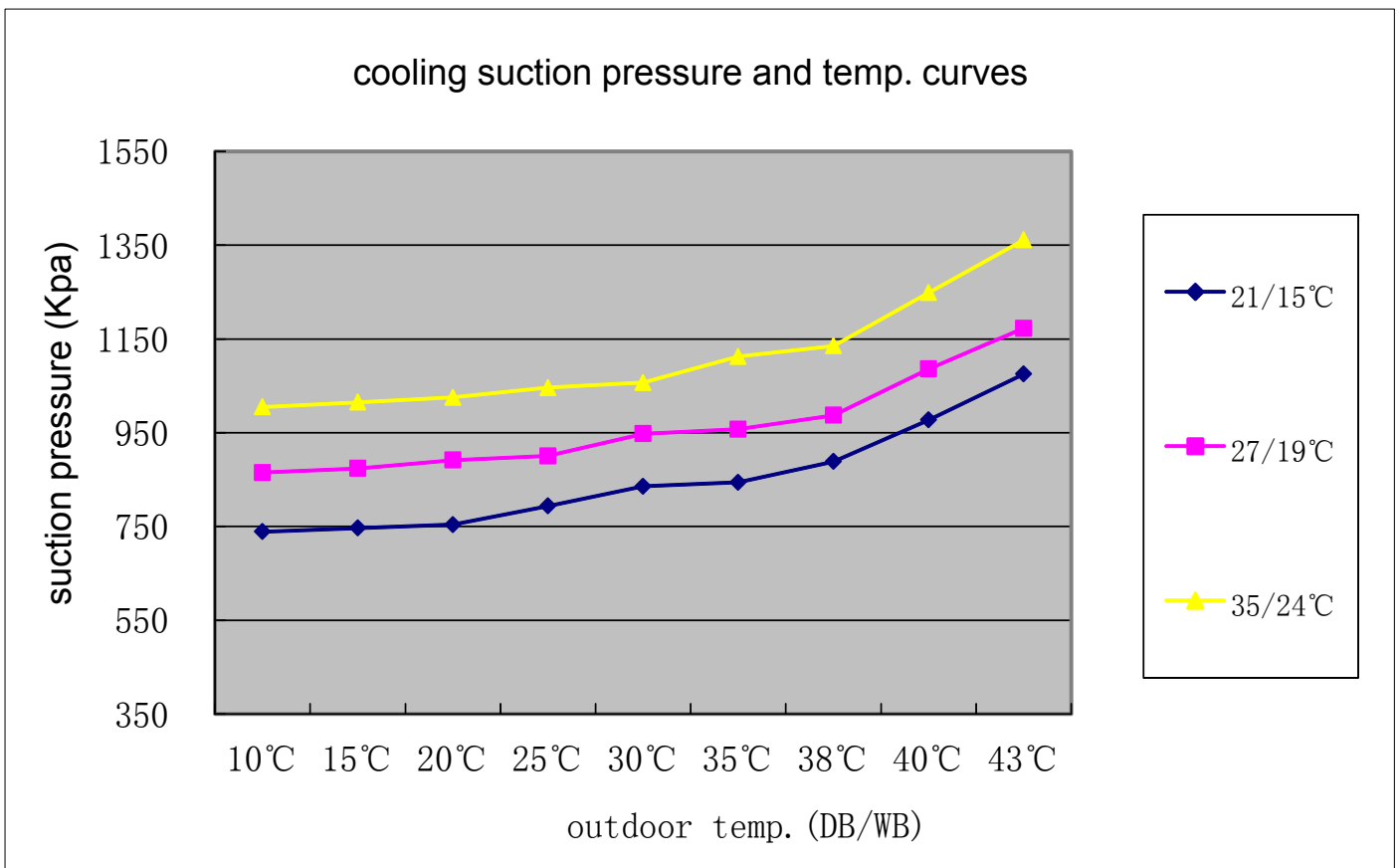

### 11.5 Heating capacity-temperature curves

| performance curves                             |                            |      |      |
|--|----------------------------|------|------|
| heating capacity and indoor/outdoor temp.table |                            |      |      |
| outdoor temp.                                  | indoor temp.(humidity 46%) |      |      |
| DB/WB  | 10°C                       | 20°C | 27°C |
| -15°C  | 3897                       | 3632 | 3464 |
| -10°C  | 5990                       | 5477 | 5052 |
| -7/-8°C  | 7361                       | 6674 | 6202 |
| 2/1°C  | 7869                       | 6945 | 6298 |
| 7/6°C  | 7659                       | 7073 | 6293 |
| 12/11°C  | 6856                       | 6316 | 5506 |
| 18/16°C  | 5609                       | 5289 | 4638 |
| 24/20°C  | 4500                       | 4045 | 3607 |

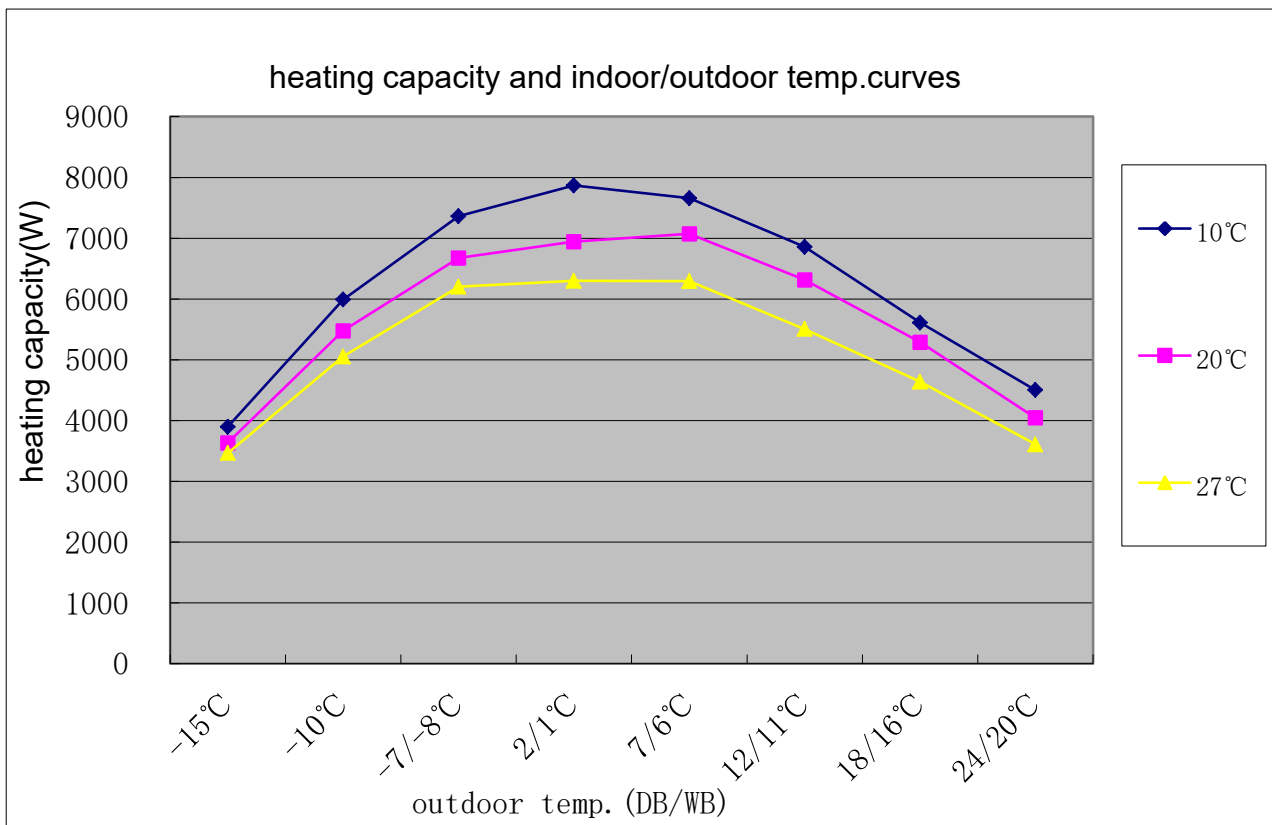

### 11.6 Heating power consumption value- temperature curves

| performance curves                 |                            |      |      |
|------------------------------------|----------------------------|------|------|
| power consumption value-temp.table |                            |      |      |
| outdoor temp.                      | indoor temp.(humidity 46%) |      |      |
| DB/WB                              | 10°C                       | 20°C | 27°C |
| -15°C                              | 1686                       | 1775 | 1881 |
| -10°C                              | 2019                       | 2103 | 2208 |
| -7/-8°C                            | 2108                       | 2243 | 2355 |
| 2/1°C                              | 2190                       | 2305 | 2420 |
| 7/6°C                              | 2028                       | 2113 | 2218 |
| 12/11°C                            | 1435                       | 1543 | 1698 |
| 18/16°C                            | 1066                       | 1185 | 1303 |
| 24/20°C                            | 753                        | 836  | 920  |

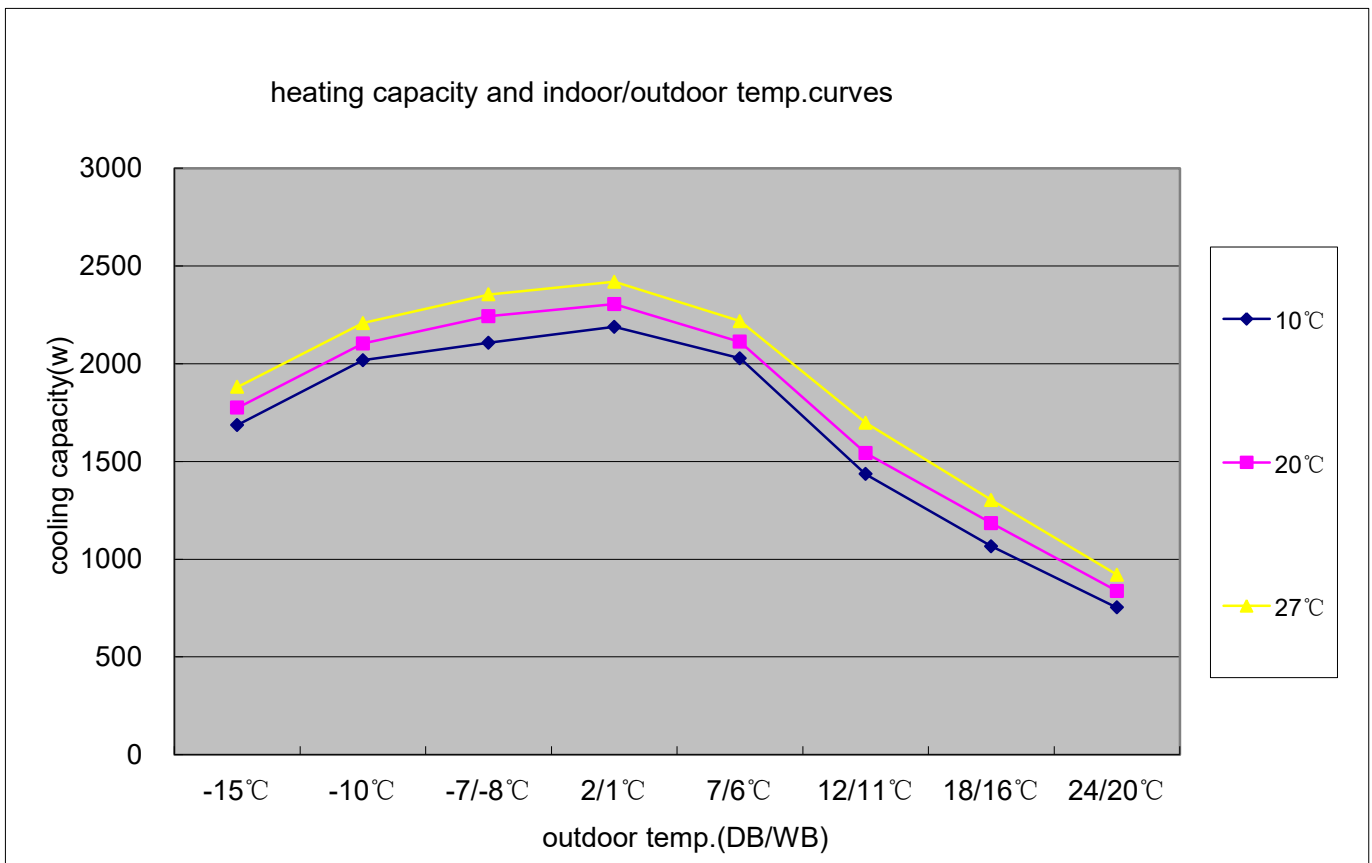

### 11.7 Heating discharge pressure curves

| performance curves               |              |      |      |
|----------------------------------|--------------|------|------|
| heating discharge pressure.table |              |      |      |
| outdoor temp                     | indoor temp. |      |      |
| DB/WB                            | 10°C         | 20°C | 27°C |
| -15°C                            | 2534         | 2706 | 2772 |
| -10°C                            | 2814         | 2917 | 3015 |
| -7/-8°C                          | 3200         | 3338 | 3436 |
| 2/1°C                            | 3365         | 3619 | 3710 |
| 7/6°C                            | 3304         | 3514 | 3605 |
| 12/11°C                          | 3232         | 3409 | 3542 |
| 18/16°C                          | 2994         | 3204 | 3380 |
| 24/20°C                          | 2559         | 2723 | 2874 |

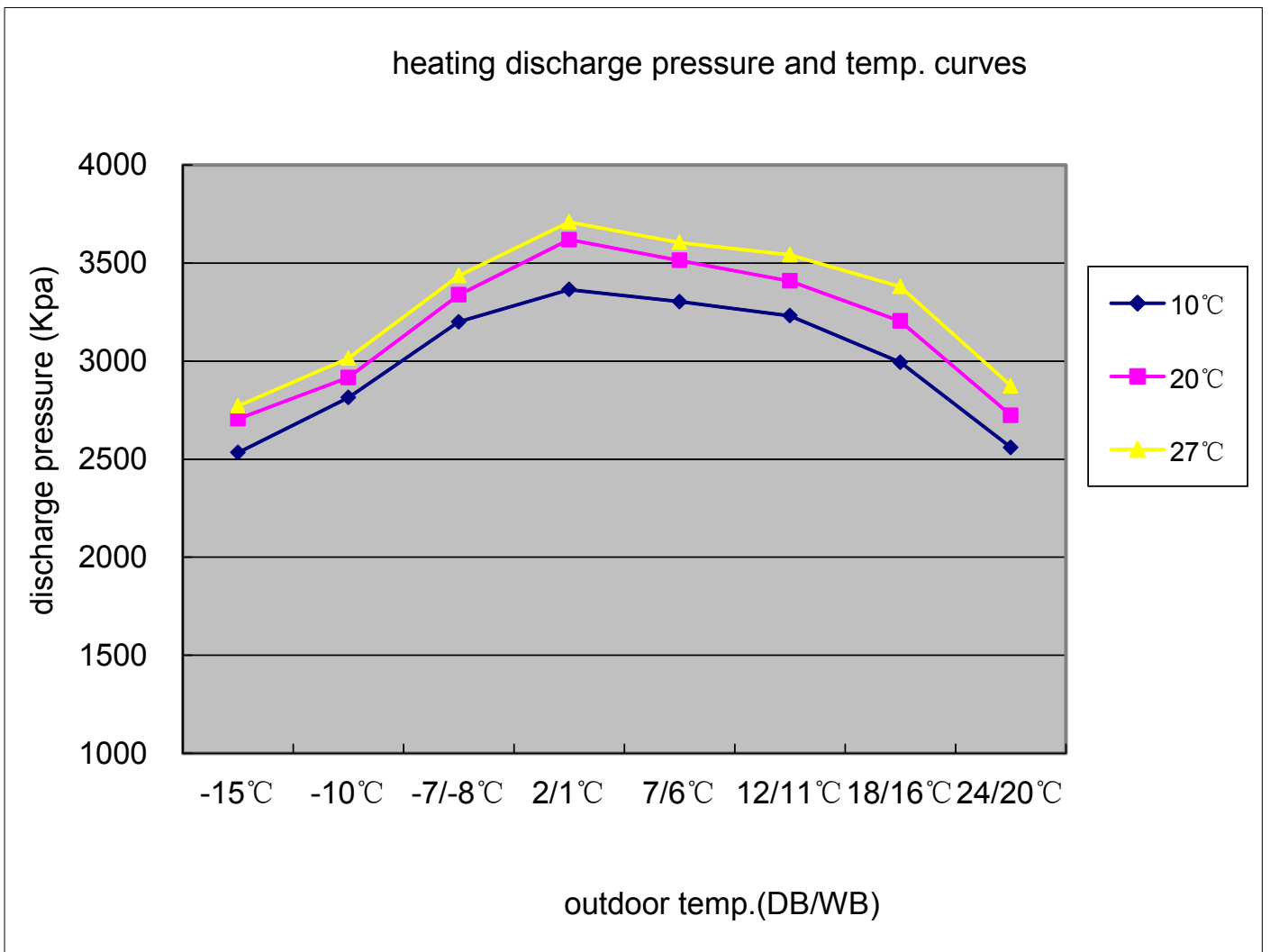

### 11.8 Heating suction pressure curves

| performance curves             |              |      |      |
|--------------------------------|--------------|------|------|
| heating suction pressure.table |              |      |      |
| outdoor temp                   | indoor temp. |      |      |
| DB/WB                          | 10°C         | 20°C | 27°C |
| -15°C                          | 345          | 385  | 404  |
| -10°C                          | 397          | 427  | 447  |
| -7/-8°C                        | 491          | 531  | 551  |
| 2/1°C                          | 610          | 650  | 670  |
| 7/6°C                          | 743          | 783  | 803  |
| 12/11°C                        | 843          | 883  | 903  |
| 18/16°C                        | 1010         | 1050 | 1070 |
| 24/20°C                        | 1196         | 1236 | 1256 |

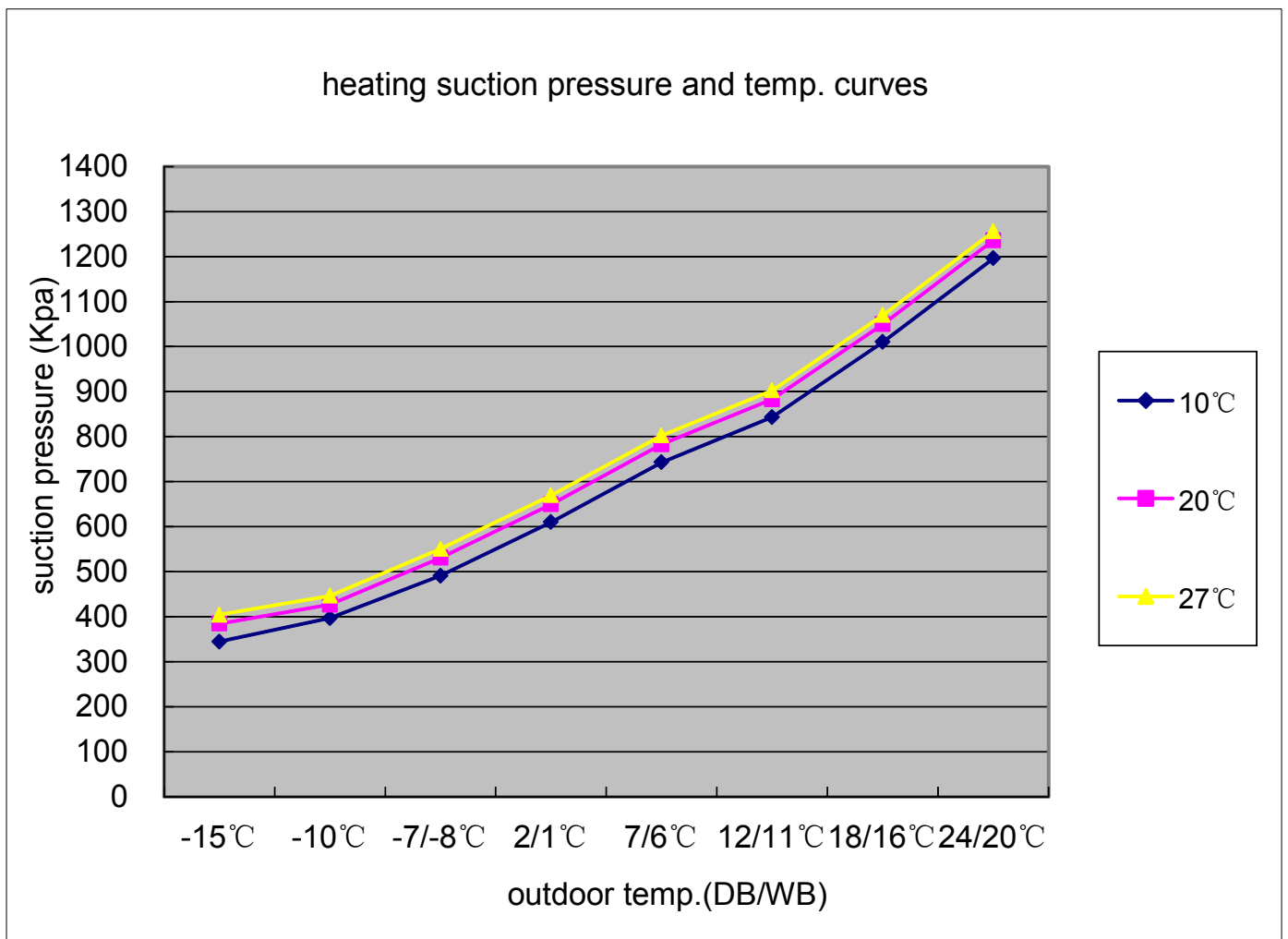

# 12.Sound level

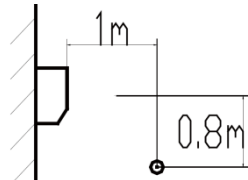
| Model      | Sound pressure level |   |    | Measuring location of microphone   | Sound power level (cooling/heating) |
|------------|----------------------|---|----|--|-------------------------------------|
|            | 230V,50HZ            |   |    |  |                                     |
|            | Cooling/heating      |   |    |  |                                     |
|            | H                    | L | SL |  |                                     |
| 1U68WEGFRA | 62                   |   |    |  | 68                                  |

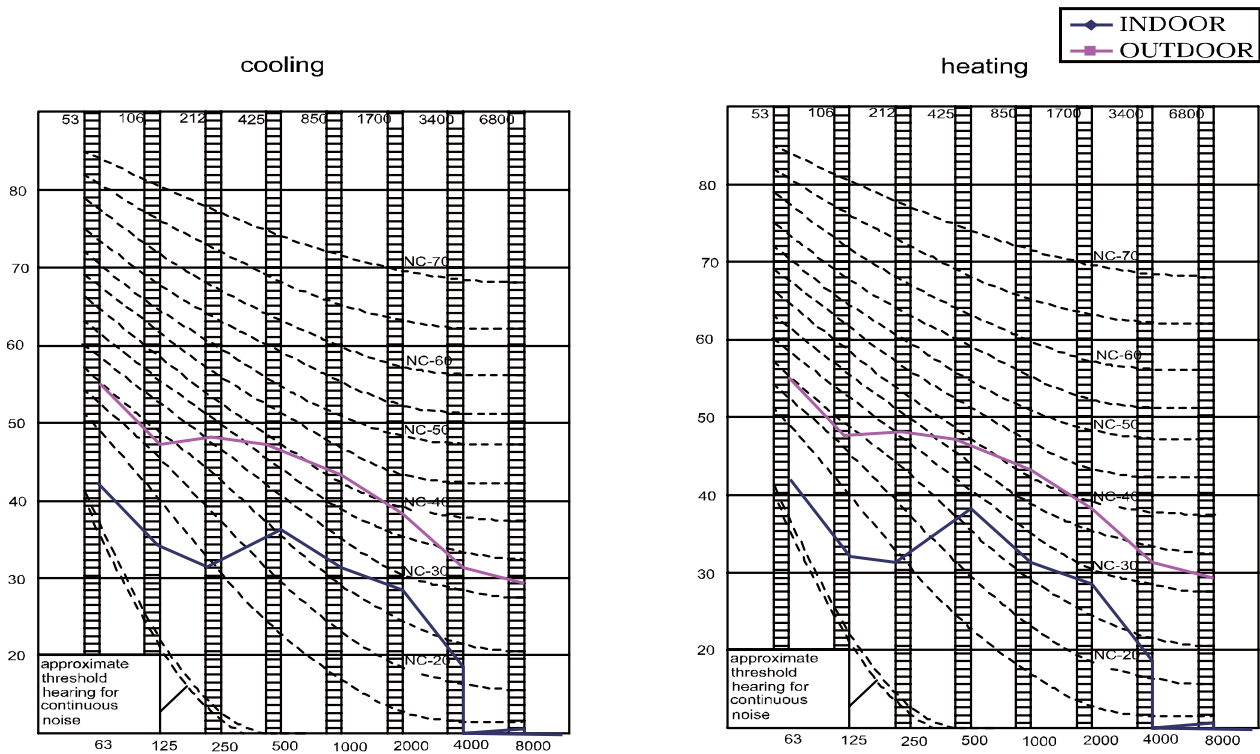

# 13 Wiring Diagrams

## 13.1 Outdoor unit control board circuit diagrams

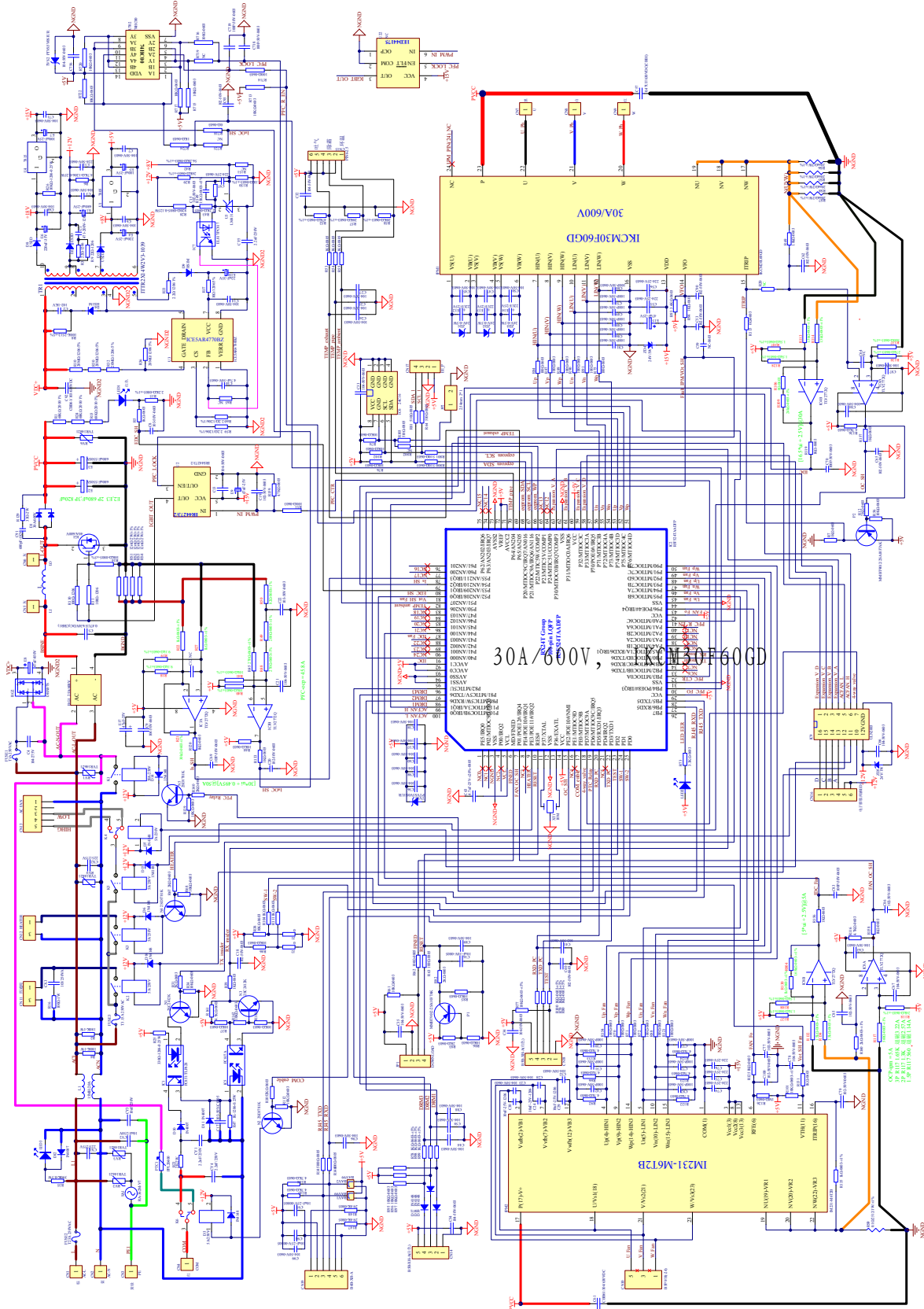

# Sincere Forever

## Haier Group

---

Haier Industrial Park, No.1, Haier Road

266101, Qingdao, China

Http: //www.haier.com

Edited by : Shi haiyan

Wang wanli

Signed by : Li jingsheng

Approved by: Yang wenjun



# Removal of procedure

Procedure



Warning Be sure to wait 10 minutes or more after turning off all power supplies before disassembling work

| Step | 1. Removal of Outdoor panel                                     | Procedure | Points |
|------|---|-----------|--------|
| 1.   | Remove the panels   |           |        |
| 1    | Loosen the screws and lift the top panel and remove the handle. |           |        |

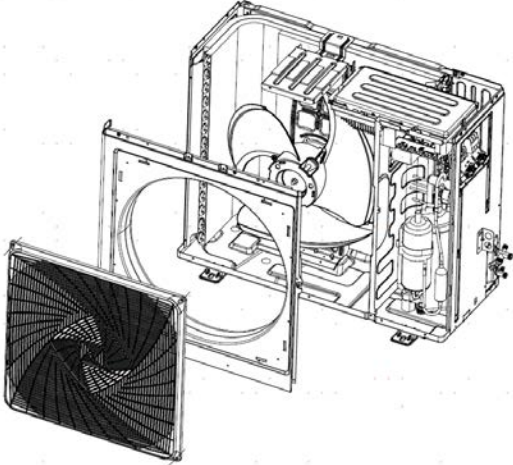
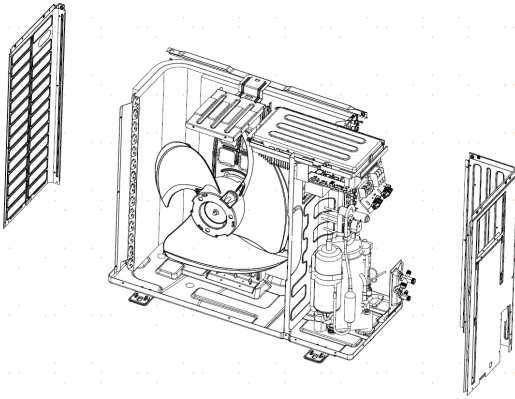
| Step |  | Procedure  | Points |
|------|--|--|--------|
| 2    | Loosen the screws of the panel, pull and remove the front panel. |    |        |
| 3    | Loosen the fixing screws and remove the side panel.              |  |        |

## 2. Removal of Electrical Box

Procedure



Warning Be sure to wait 10 minutes or more after turning off all power supplies before disassembling work

| Step |   | Procedure | Points |
|------|---|-----------|--------|
| 1    | Remove the fixing screws, than lift the electrical box. |           |        |

### 3. Removal of Fan and Fan Motor

Procedure



Warning Be sure to wait 10 minutes or more after turning off all power supplies before disassembling work

| Step |   | Procedure | Points |
|------|---|-----------|--------|
| 1    | Loosen the fixing screw and remove the fan. |           |        |

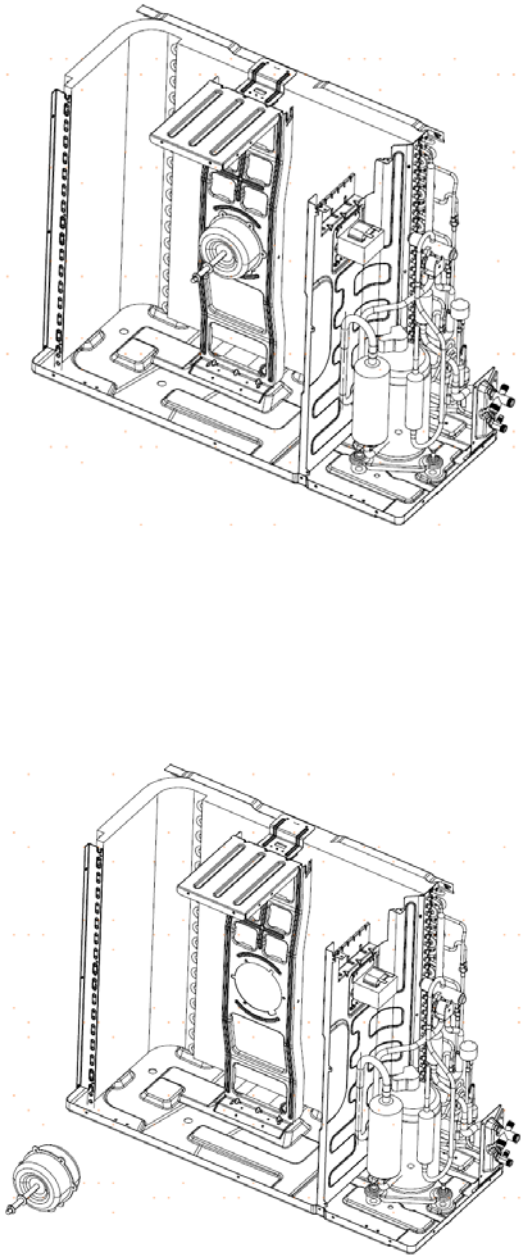
| Step |  | Procedure   | Points   |
|------|--|---|--|
| 2    | Loosen the fixing screws and remove the fan motor. |  | Put the head wire through the back of the motor when assembling.(so as not to be entangled with the propeller fan) |

## 4. Removal of fan motor bracket and partition

Procedure



Warning Be sure to wait 10 minutes or more after turning off all power supplies before disassembling work

| Step |  | Procedure | Points |
|------|--|-----------|--------|
| 1    | Loosen the fixing screws and remove the fan motor bracket. |           |        |

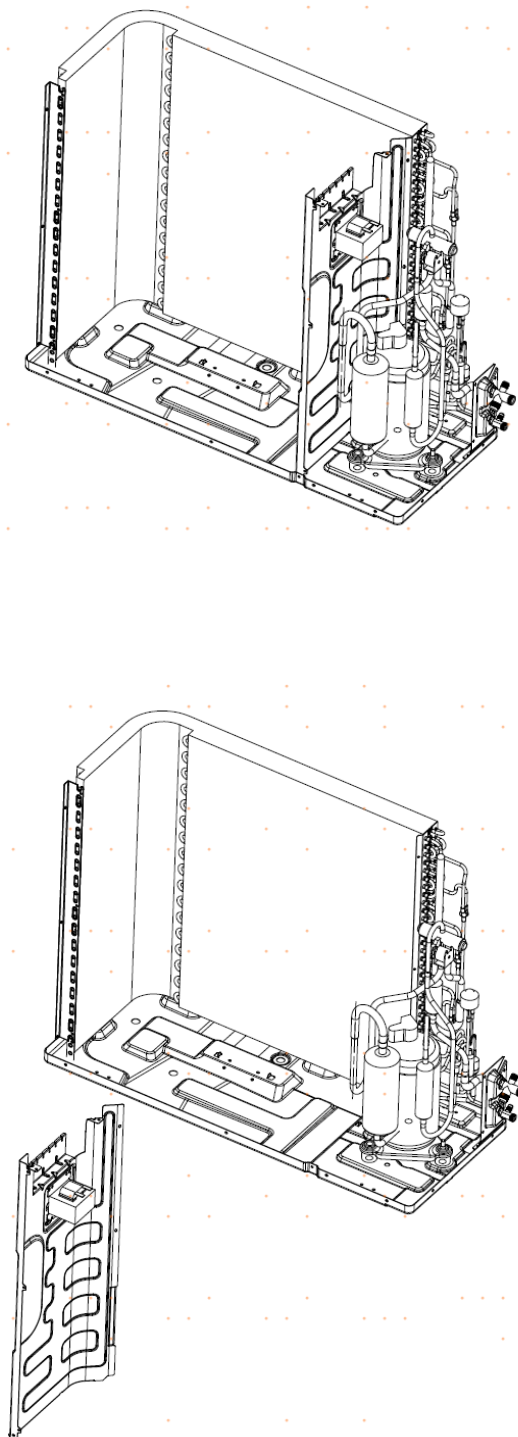
| Step |  | Procedure   | Points  |
|------|--|---|---|
| 2    | <p>Loosen the fixing screws. The partition plate has a hook on the lower side, than lift and pull the proof plate. Remove the partition plate.</p> |  | <p>When assembling, fit the lower hook into the bottom frame.</p> |



## 5 Removal of compressor and heat exchanger

Procedure



Warning Be sure to wait 10 minutes or more after turning off all power supplies before disassembling work

| Step |  | Procedure | Points |
|------|--|-----------|--------|
| 1    | <p>Cut down the connecting pipe and put out the compressor and remove the valve bracket.</p> |           |        |



| Step |   | Procedure  | Points |
|------|---|--|--------|
| 2    | <p>Loosen the marked fixing screws and remove the heat exchanger.</p> | <p>The procedure is illustrated in three stages: 1. The heat exchanger is shown being lifted away from the chassis. 2. The chassis is shown with the heat exchanger removed. 3. The chassis is shown with the heat exchanger removed and the screws being taken out.</p> |        |